



---

# SERVICE STATION MANUAL

---

**XXXX**

---



**Fuoco 500 i.e.**

---



# **SERVICE STATION MANUAL**

## **Fuoco 500 i.e.**

The descriptions and illustrations given in this publication are not binding. While the basic specifications as described and illustrated in this booklet remain unchanged, PIAGGIO-GILERA reserves the right, at any time and without being required to update this publication beforehand, to make any changes to components, parts or accessories, which it considers necessary to improve the product or which are required for manufacturing or construction reasons.

Not all versions shown in this publication are available in all Countries. The availability of single versions should be checked at the official Piaggio sales network.

"© Copyright 2007 - PIAGGIO & C. S.p.A. Pontedera. All rights reserved. Reproduction of this publication in whole or in part is prohibited."

PIAGGIO & C. S.p.A. - After-Sales

V.le Rinaldo Piaggio, 23 - 56025 PONTEDERA (Pi)

---

---

# SERVICE STATION MANUAL

## Fuoco 500 i.e.

This service station manual has been drawn up by Piaggio & C. Spa to be used by the workshops of Piaggio-Gilera dealers. It is assumed that the user of this manual for maintaining and repairing Piaggio vehicles has a basic knowledge of mechanical principles and vehicle repair technique procedures. Any significant changes to vehicle characteristics or to specific repair operations will be communicated by updates to this manual. Nevertheless, no mounting work can be satisfactory if the necessary equipment and tools are unavailable. It is therefore advisable to read the sections of this manual concerning special tools, along with the special tool catalogue.

**N.B.** Provides key information to make the procedure easier to understand and carry out.

**CAUTION** Refers to specific procedures to carry out for preventing damages to the vehicle.

**WARNING** Refers to specific procedures to carry out to prevent injuries to the repairer.



**Personal safety** Failure to completely observe these instructions will result in serious risk of personal injury.



**Safeguarding the environment** Sections marked with this symbol indicate the correct use of the vehicle to prevent damaging the environment.



**Vehicle intactness** The incomplete or non-observance of these regulations leads to the risk of serious damage to the vehicle and sometimes even the invalidity of the guarantee.

---



## INDEX OF TOPICS

CHARACTERISTICS

CHAR

TOOLING

TOOL

MAINTENANCE

MAIN

TROUBLESHOOTING

TROUBL

ELECTRICAL SYSTEM

ELE SYS

ENGINE FROM VEHICLE

ENG VE

ENGINE

ENG

INJECTION

INJEC

SUSPENSIONS

SUSP

BRAKING SYSTEM

BRAK SYS

COOLING SYSTEM

COOL SYS

CHASSIS

CHAS

PRE-DELIVERY

PRE DE

TIME

TIME



## INDEX OF TOPICS

CHARACTERISTICS

CHAR

This section describes the general specifications of the vehicle.

---

## Rules

This section describes general safety rules for any maintenance operations performed on the scooter.

---

### Safety rules

- If work can only be done on the vehicle with the engine running, make sure that the premises are well ventilated, using special extractors if necessary; never let the engine run in an enclosed area. Exhaust fumes are toxic.
  - The battery electrolyte contains sulphuric acid. Protect your eyes, clothes and skin. Sulphuric acid is highly corrosive; in the event of contact with your eyes or skin, rinse thoroughly with abundant water and seek immediate medical attention.
  - The battery produces hydrogen, a gas that can be highly explosive. Do not smoke and avoid sparks or flames near the battery, especially when charging it.
  - Fuel is highly flammable and it can be explosive given some conditions. Do not smoke in the working area, and avoid open flames or sparks.
  - Clean the brake pads in a well ventilated area, directing the jet of compressed air in such a way that you do not breathe in the dust produced by the wear of the friction material. Even though the latter contains no asbestos, inhaling dust is harmful.
- 

### Maintenance rules

- Use original PIAGGIO spare parts and lubricants recommended by the Manufacturer. Non-original or non-conforming spares may damage the vehicle.
  - Use only the appropriate tools designed for this vehicle.
  - Always use new gaskets, sealing rings and split pins upon reassembly.
  - After removal, clean the components using non-flammable or low flash-point solvent. Lubricate all the work surfaces except the tapered couplings before refitting.
  - After refitting, make sure that all the components have been installed correctly and work properly.
  - For removal, overhaul and refit operations use only tools with metric measures. Metric bolts, nuts and screws are not interchangeable with coupling members with English measurement. Using unsuitable coupling members and tools may damage the scooter.
  - When carrying out maintenance operations on the scooter that involve the electrical system, make sure the electrical connections have been made properly, particularly the ground and battery connections.
-



**Vehicle identification**

**Frame prefix (A):**

ZAPM61100

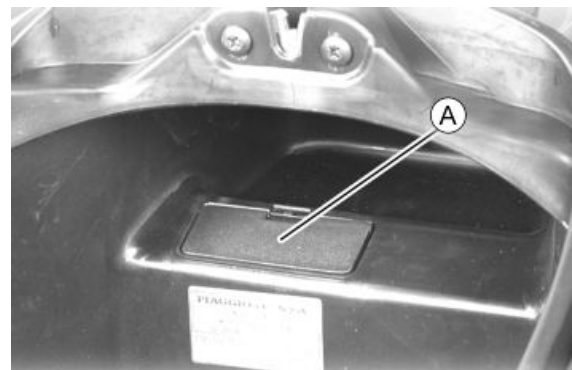

**Engine prefix (B):**

M661M

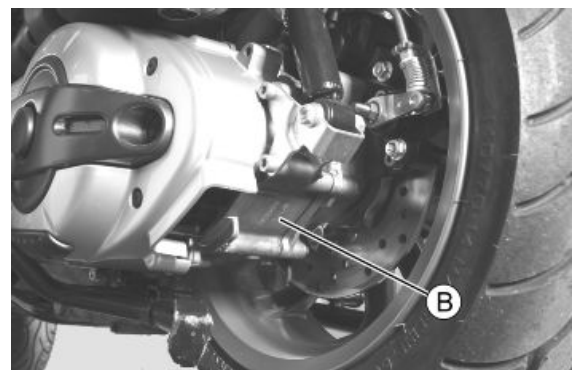

**Dimensions and mass**

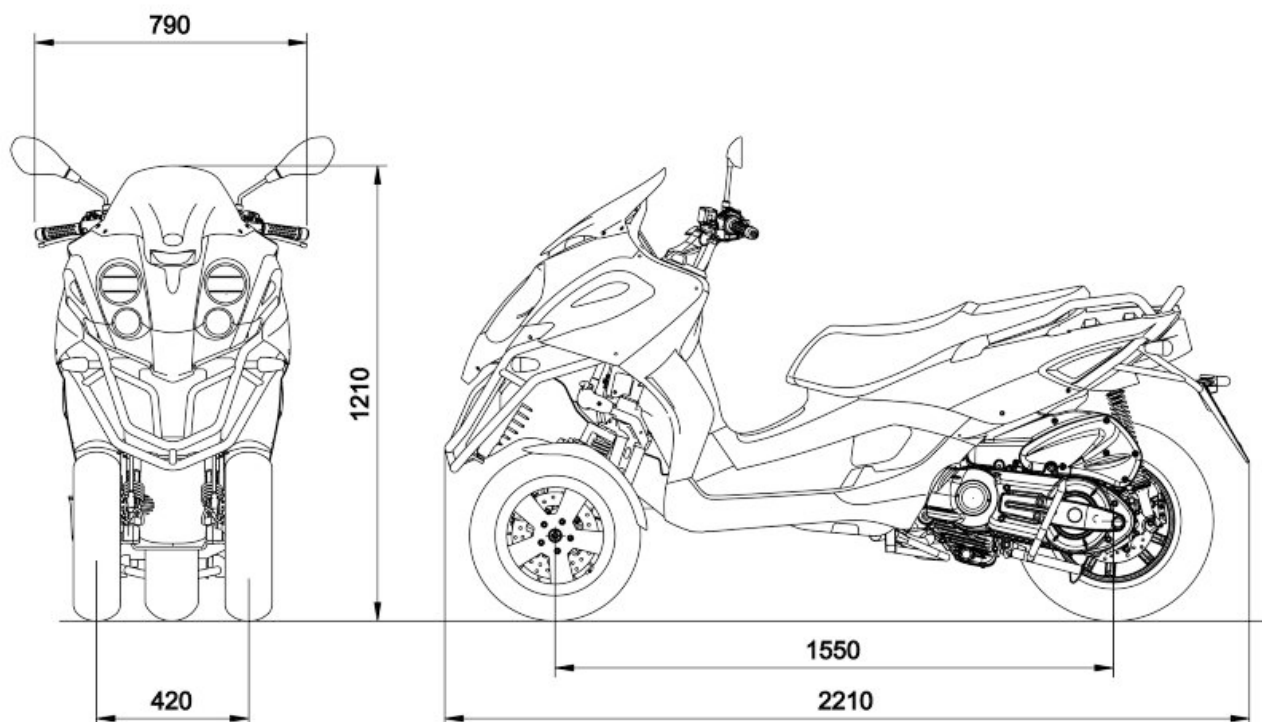

**WEIGHTS AND DIMENSIONS**

<b>Specification</b>	<b>Desc./Quantity</b>
Kerb weight	253 ± 5 kg
Maximum weight allowed	445 kg
Maximum height	1.210 mm
Width	790 mm
Wheelbase	1.550 mm
length	2.210 mm
Track	420 mm

**Engine****ENGINE**

<b>Specification</b>	<b>Desc./Quantity</b>
Type	Single-cylinder, 4-stroke with double spark plug
Cubic capacity	493 cm <sup>3</sup>
Bore x Stroke	94 x 71 mm
Compression ratio	10.5: 1
Engine idle speed	1,500 ± 100 rpm
Timing system	Four valves, single overhead camshaft, chain driven.
Valve clearance	Inlet: 0.15 mm Outlet: 0.15 mm
MAX. power	29 kW at 7,500 rpm
MAX torque	44 Nm at 5,200 rpm
Lubrication	Engine lubrication with lobe pump (inside crankcase) controlled by a chain with double filter: mesh and paper.
Lubrication pressure	3.5 ÷ 4 bar
Minimum lubrication pressure (100° C)	0.8 bar
Fuel supply	Electronic injection with electric fuel pump.
Cooling	Forced coolant circulation system.
Fuel	Unleaded petrol (95 RON)

**Transmission****TRANSMISSION**

<b>Specification</b>	<b>Desc./Quantity</b>
Transmission	Automatic expandable pulley variator with torque server, V belt, dry self-ventilating automatic centrifugal clutch and transmission housing with forced air circulation.
Final reduction	Gear reduction unit in oil bath.

**Capacities****CAPACITY**

<b>Specification</b>	<b>Desc./Quantity</b>
Engine oil	1.7 l

Specification	Desc./Quantity
Transmission oil	250 cm <sup>3</sup>
Cooling system fluid	~ 1.8 l
Fuel tank (reserve)	~ 12 l (~2 l)

## Electrical system

### ELECTRICAL SYSTEM

Specification	Desc./Quantity
Start-up	Electric
Ignition	High efficiency electronic inductive ignition, integrated with the injection system, with variable advance and separate HV coil.
Ignition advance	Three-dimensional map managed by control unit
Spark plug	NGK CR7EKB
Alternative spark plug	-
Battery	12 V / 14 Ah, SEALED BATTERY
Generator	In alternating current

## Frame and suspensions

### FRAME AND SUSPENSIONS

Specification	Desc./Quantity
Chassis	Tubular and sheet steel
Front suspension	The tilt mechanism is composed of an articulated parallelogram suspension with die-cast aluminium control arms and two side headstocks plus shock absorbers with hydraulic locking system.
Front suspension travel	85 mm
Rear suspension	Two double-acting shock absorbers, adjustable to four positions at preloading.
Rear suspension travel	110 mm

## Brakes

### BRAKES

Specification	Desc./Quantity
Front brake	Ø 240 mm double disk with hydraulic control activated by the handlebar right-hand lever.
Rear brake	disc brake, diameter 240 mm, with hydraulic servo operated from the handlebar with the left-hand lever.

## Wheels and tyres

### WHEELS AND TYRES

Specification	Desc./Quantity
Wheel rim type	Light alloy rims.
Front rim	12" x 3.00

Specification	Desc./Quantity
Rear rim	14" x 4.50
Front tyre	Tubeless 120/70-12" 51S or 51P
Rear tyre	Tubeless 140/70 - 14" 68S or 68P reinf
Front tyre pressure (with passenger)	1.6 bar (1.8 bar)
Rear tyre pressure (with passenger)	2.4 bar (2.6 bar)

## Tightening Torques

### STEERING

Name	Torque in Nm
Steering lower ring nut (central headstock)	22 ÷ 27 loosen by 90°
Steering upper ring nut (central headstock)	27 ÷ 33
Handlebar fixing screw	50 ÷ 55
Fixing screws for handlebar control assembly U-bolts	7 ÷ 10

### CHASSIS

Name	Torque in Nm
Swinging arm set screw bushing	5 ÷ 7
Engine arm bolt - frame arm	32.5 ÷ 40
Swinging arm set screw bushing nut	54 ÷ 60
Engine-swinging arm bolt	98 ÷ 118
Frame-swinging arm bolt	54 ÷ 60
Centre stand bolt	31 ÷ 39

### FRONT SUSPENSION

Name	Torque in Nm
Shock absorber lower clamp	19 ÷ 26
Upper shock absorber clamp	19 ÷ 29
Front wheel fixing screws	19 ÷ 24
Steering arm bolt nut	20 ÷ 25
Tilt calliper fixing screws	20 ÷ 25
Front wheel shaft	74 ÷ 88
Arm coupling screws	45 ÷ 50
Screws fixing arms to side headstocks	45 ÷ 50
Screws fixing arms to central headstock	45 ÷ 50
Screws fixing the half-arm coupling flange	20 ÷ 25
Fixing screws for tilt locking disc section	20 ÷ 25
Side headstock upper ring nut	20 - 24
Side headstock lower ring nut	12 ÷ 15
Screw fixing sliding stem to shock absorber	45 ÷ 50
Clamp for sliding stem locking device	6.5 ÷ 10.5
Fixing nuts for constant-velocity universal joints	18 ÷ 20
Potentiometer to anti-tilting device clamp	8 ÷ 10
Electric motor to anti-tilting device clamp	11 ÷ 13
Clamp fixing pump bolt to anti-tilting device	11 ÷ 13
Pump to anti-tilting device clamp	11 ÷ 13
Pressure switch to distribution frame	18 ÷ 20
Sensor to tilt gripper clamp	2.5 ÷ 2.9
Pipe terminals to fifth wheel check spring	7 ÷ 11
Joint to anti-tilting device pump	20 ÷ 25

Name	Torque in Nm
Lower fitting for shock absorber sliding locking clamp pipes	20 ÷ 25
Upper fitting for shock absorber sliding locking clamp pipes	20 ÷ 25

**REAR SUSPENSION**

Name	Torque in Nm
Upper shock absorber clamp	33 ÷ 41
Shock absorber lower clamp	33 ÷ 41
Shock absorber-crankcase attachment bracket	20 ÷ 25
Rear wheel axle	104 ÷ 126
Muffler arm clamping screws	27 ÷ 30

**FRONT BRAKE**

Name	Torque in Nm
Calliper coupling screw	22 ÷ 27
Oil bleed screw	8 ÷ 12
Disc tightening screw (°)	5 - 6
Brake fluid pump - hose fitting	16 ÷ 20
Brake fluid hose-calliper fitting	20 ÷ 25
Screw tightening calliper to the support	20 ÷ 25
Calliper upper pipe fitting	20 ÷ 25

**REAR BRAKE**

Name	Torque in Nm
Oil bleed screw	12 ÷ 16
Rear brake disc screws(°)	5 ÷ 6.5
Rear brake calliper-pipe fitting	20 ÷ 25
Rigid / flexible pipe fitting	13 ÷ 18
Rear brake pump-pipe fitting	16 ÷ 20
Rear brake calliper fixing screws	20 ÷ 25
pad fastening pin screws	20 ÷ 25

**REAR BRAKE**

Product	Description	Specifications
(°) Loctite 243	Medium strength threadlock	Apply LOCTITE 243 medium strength threadlock

**MUFFLER**

Name	Torque in Nm
Muffler heat guard fixing screw	4 ÷ 5
Screw for fixing muffler to the support arm	20 ÷ 25
Lambda probe clamp on exhaust manifold	40 ÷ 50
Exhaust manifold-muffler joint clamp	12 ÷ 13
Manifold - muffler diaphragm tightening clamp	16 ÷ 18

**LUBRICATION**

Name	Torque in Nm
Oil pump cover screws	0.7 ÷ 0.9
Screws fixing oil pump to the crankcase	5 - 6

**THERMAL UNIT AND TIMING SYSTEM**

Name	Torque in Nm
Spark plug	12 ÷ 14
Head fixing stud bolts:	***
Head fixing nuts	10 - 12
Exhaust / intake head fixing nuts:	10 - 12
Head lubrication control jet	5 - 7
Coolant temperature sensor	10 ÷ 12
counterweight mass fixing screw	7 - 8.5
Tensioner sliding block fixing screw:	10 - 14
Rpm timing sensor fixing screw:	3 - 4
injector fixing screw	3 ÷ 4
Rpm timing sensor fixing screw	3 ÷ 4
Valve lifter mass stop bell fixing screws:	30 - 35
inlet manifold fixing screws	11 - 13
Tappet cover fixing screws:	7 - 9
Throttle body fixing screws	11 ÷ 13
Camshaft retaining bracket fixing screws	4 - 6
Head fixing screws	10 - 12
Lambda probe on exhaust manifold	10 - 12
Muffler to bracket fixing screw	14 - 16

\*\*\* Apply a preliminary torque of 7 Nm in a crossed sequence. - Tighten by 90° in a crossed sequence. - Tighten again by 90° in a crossed sequence.

**TRANSMISSION COVER**

Name	Torque in Nm
Driven pulley nut	92 - 100
Drive pulley nut	160 - 175
Anti-vibration roller screw	16.7 - 19.6
M8 retainers for transmission cover	23 - 26
M6 retainer	11 ÷ 13
Anti-vibration roller retainer	17 - 19
Clutch ring nut	65 - 75
Air deflector unit screws	7 ÷ 9
Water pump cover screws	3 ÷ 4
Outside transmission cover screws	7 ÷ 9
Flywheel cover screws	11 - 13

**FLYWHEEL COVER**

Name	Torque in Nm
Flywheel fixing nut	115 - 125
Stator retainers	8 - 10
Blow-by recovery duct fixing screws	3 - 4
Screw fixing freewheel to flywheel	13 - 15
Stator cable harness guide bracket screws	3 - 4

**CRANKCASE AND CRANKSHAFT**

Name	Torque in Nm
Countershaft fixing nut	25 - 29
Engine oil filter	12 - 16
Engine oil drainage plug	24 ÷ 30
Engine-crankcase coupling screws	11 ÷ 13
Oil pump screws	5 - 6

Name	Torque in Nm
Gear mounting on crankshaft screws	10 -12
Bulkhead screws for oil pump housing cover	8 - 10

**COOLING**

Name	Torque in Nm
Water pump rotor cover	3 ÷ 4
Thermostat cover screws	3 ÷ 4
Bleed screw:	3

**FINAL REDUCTION**

Name	Torque in Nm
Rear hub cover screws	24 ÷ 27

**ENGINE ASSEMBLY**

Name	Torque in Nm
starter motor retainers	11 - 13

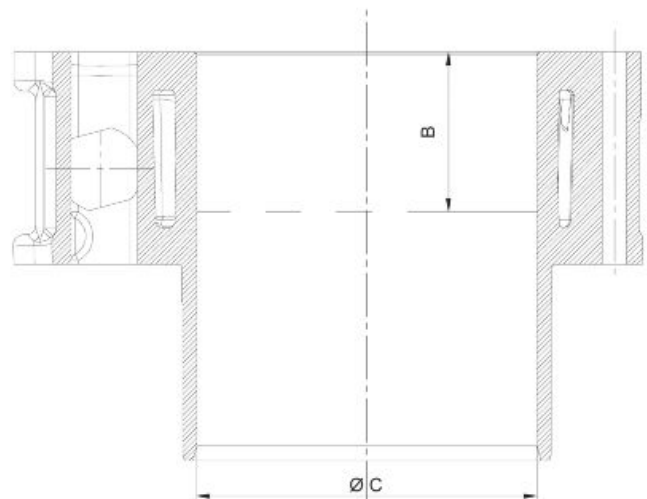
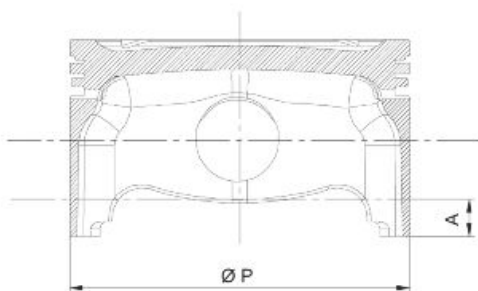
**Overhaul data****Assembly clearances****Cylinder - piston assy.**

**HEIGHT TO MEASURE THE PISTON**

Specification	Desc./Quantity
A	10 mm
B	43 mm

**CYLINDER - PISTON**

Specification	Desc./Quantity
Cylinder diameter C	94 +0.018-0.01mm
Piston diameter P	93.968 - ±0.014 mm

**COUPLING CATEGORIES**

Name	Initials	Cylinder	Piston	Play on fitting
Cylinder- Piston	A	93.990÷93.997	93.954÷93.961	0.029÷0.043
Cylinder- Piston	B	93.997÷93.004	93.961÷93.968	0.029÷0.043
Cylinder- Piston	C	94.004÷94.011	93.968÷93.975	0.029÷0.043
Cylinder- Piston	D	94.011÷94.018	93.975÷93.982	0.029÷0.043

N.B.

**THE PISTON MUST BE INSTALLED WITH THE ARROW FACING TOWARDS THE OUTLET SIDE, THE PISTON RINGS MUST BE INSTALLED WITH THE WORD «TOP» OR THE STAMPED MARK FACING UPWARDS.**

**Piston rings**

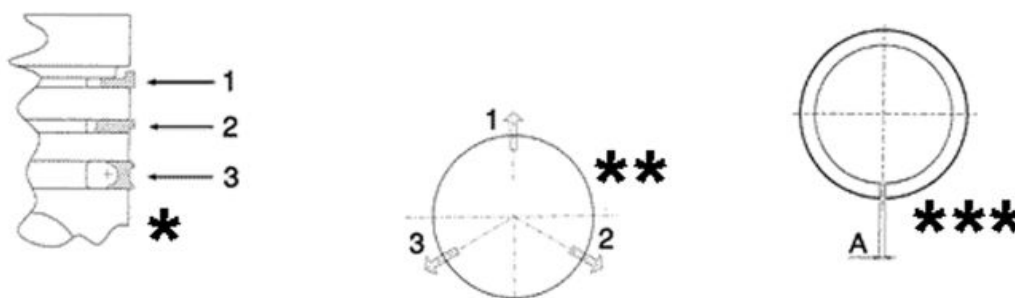

\*Fit rings «2» and «3» with the word «TOP» facing upwards.

\*\* Position the openings in the rings as shown here.

\*\*\*Value «A» of sealing ring inside the cylinder.

**Check the size of the sealing ring opening:**

**Compression ring:** 0.15 ÷ 0.35 mm. Max. value 0.5 mm



**Oil scraper ring:**  $0.25 \div 0.50$  mm. Max. value 0.65 mm

**Oil scraper ring:**  $0.25 \div 0.50$  mm. Max. value 0.65 mm

**Rings/housing coupling clearances:**

Carefully clean the sealing ring housings.

Place a thickness gauge between the ring and the housing as shown in the drawing and check the coupling clearances.

**Top ring Standard coupling clearance:**

$0.01 \div 0.06$  mm

**Maximum clearances allowed after use:** 0.10 mm

**Intermediate ring Standard coupling clear-**

**ance:**  $0.02 \div 0.07$  mm

**Maximum clearances allowed after use:** 0.10 mm

**Oil scraper ring Standard coupling clearance:**

$0.01 \div 0.06$  mm

**Maximum clearances allowed after use:** 0.10 mm

Replace the piston if clearances exceed the maximum limits specified in the table.

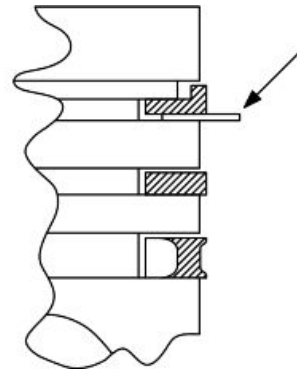

**Crankcase - crankshaft - connecting rod**

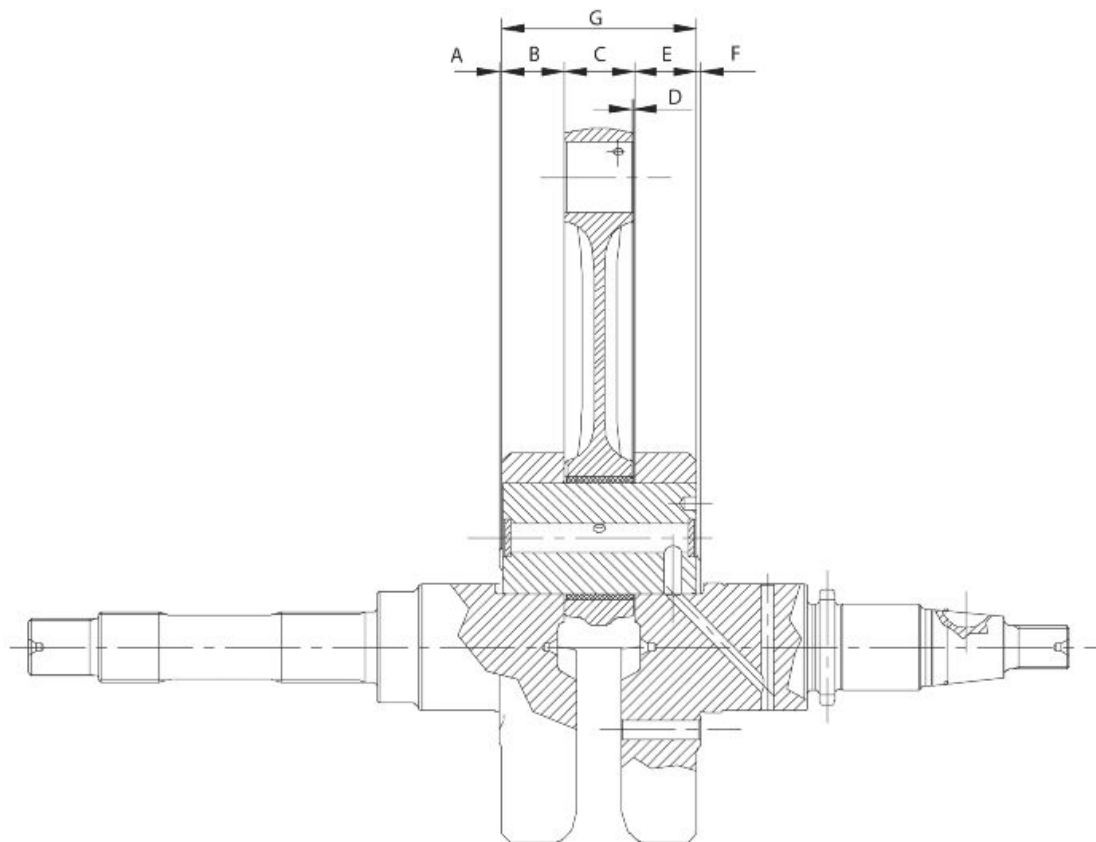

**AXIAL CLEARANCE BETWEEN CRANKSHAFT AND CONNECTING ROD**

Name	Description	Dimensions	Initials	Quantity
Transmission-side shoulder		$1 \pm 0.025$	A	$D = 0.20 \div 0.50$
Half-shaft, transmission side		$20.9 - 0.05$	B	$D = 0.20 \div 0.50$
Connecting rod		$22 \ 0.10 - 0.15$	C	$D = 0.20 \div 0.50$
Flywheel-side shoulder		$1.8 \pm 0.025$	F	$D = 0.20 \div 0.50$
Flywheel side half-shaft		$19.6 + 0.05$	E	$D = 0.20 \div 0.50$
Complete crankshaft		$65.5 +0.1 -0.05$	G	$D = 0.20 \div 0.50$

**Diameter of crankshaft bearings.**

Measure the capacity on both axes x-y.

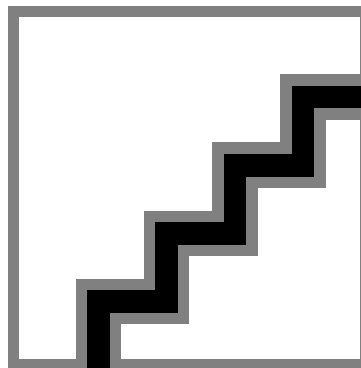
**CRANKSHAFT**

Specification	Desc./Quantity
Cat. 1	Standard diameter: 40.010 ÷ 40.016
Cat. 2	Standard diameter: 40.016 ÷ 40.022

**Crankshaft alignment****Specific tooling**

020335Y Magnetic support for dial gauge

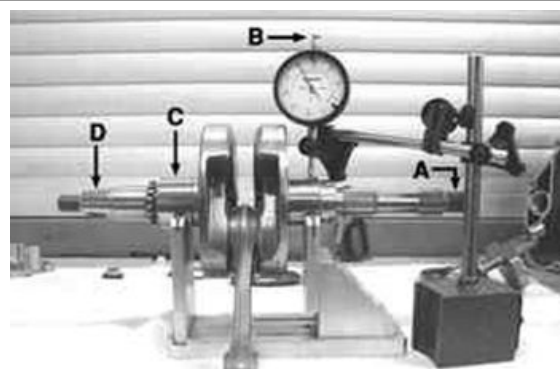
**MAX. ADMISSIBLE DISPLACEMENT**

Specification	Desc./Quantity
A =	0.15 mm
B =	0.010 mm
C =	0.010 mm
D =	0.10 mm

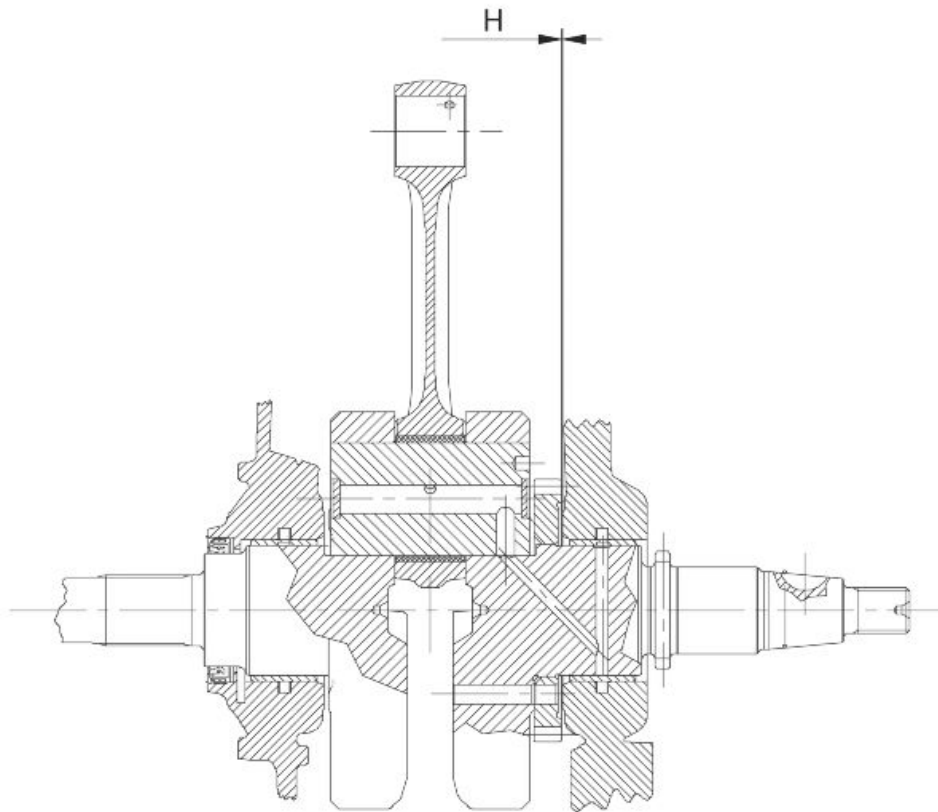

**Characteristic**

**Crankshaft-crankcase axial clearance (H)**

0.1 ÷ 0.405 mm (when cold)

**Compression ratio**

10.5: 1

**Slot packing system**

Shimming system to control compression ratio

**DISTANCE «A» IS A PROTRUSION OR RECESS VALUE OF THE PISTON CROWN WITH RESPECT TO THE CYLINDER PLANE. DISTANCE «A» HELPS DETERMINE THE THICKNESS OF GASKET «B» THAT HAS TO BE FITTED TO THE CYLINDER HEAD IN ORDER TO RESTORE COMPRESSION RATIO. BASE GASKET «B» MUST BE THICKER THE MORE THE PLANE FORMED BY THE PISTON TOP PROTRUDES FROM THE PLANE FORMED BY THE CYLINDER HEAD. ON THE OTHER HAND, THE MORE THE PISTON TOP IS RECESSED INTO THE CYLINDER TOP PLANE, THE SMALLER THE GASKET THICKNESS.**

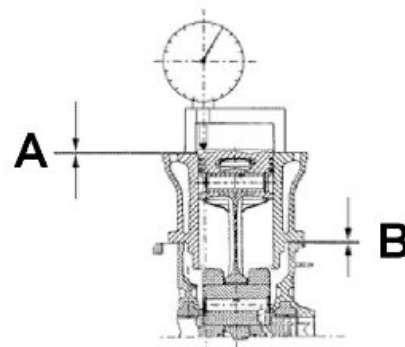

**Characteristic****Compression ratio**

10.5: 1

**BASE GASKET THICKNESS**

<b>Name</b>	<b>Measure A</b>	<b>Thickness</b>
«A» MEASURE TAKEN	- 0.185 - - 0.10	0.4 ± 0.05
«A» MEASURE TAKEN	- 0.10 - + 0.10	0.6 ± 0.05
«A» MEASURE TAKEN	+ 0.10 - + 0.185	0.8 ± 0.05

N.B.

**VALUES INDICATED WITH «-» REFER TO PISTON CROWN RECESSES WITH RESPECT TO THE CYLINDER PLANE.**

N.B.

**DISTANCE «A» MUST BE MEASURED WITHOUT ANY GASKET FITTED AT «B»**

**Products****RECOMMENDED PRODUCTS TABLE**

<b>Product</b>	<b>Description</b>	<b>Specifications</b>
AGIP ROTRA 80W-90	Rear hub oil	SAE 80W/90 Oil that exceeds the requirements of API GL3 specifications
AGIP CITY HI TEC 4T	Oil to lubricate flexible transmissions (throttle control)	Oil for 4-stroke engines
AGIP FILTER OIL	Oil for air filter sponge	Mineral oil with specific additives for increased adhesiveness
AGIP GP 330	Grease for brake levers, throttle	White calcium complex soap-based spray grease with NLGI 2; ISO-L-XBCIB2
AGIP CITY HI TEC 4T	Engine oil	SAE 5W-40, API SL, ACEA A3, JASO MA Synthetic oil
AGIP BRAKE 4	Brake fluid	FMVSS DOT 4 Synthetic fluid
SPECIAL AGIP PERMANENT fluid	coolant	Monoethylene glycol-based anti-freeze fluid, CUNA NC 956-16







## INDEX OF TOPICS



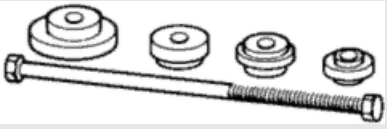

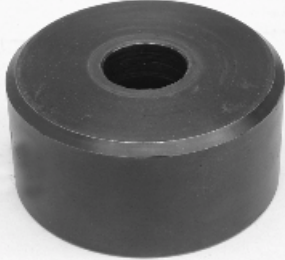

TOOLING





TOOL

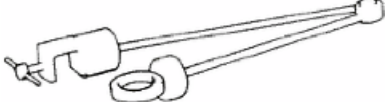

**SPECIFIC TOOLS CORRECT**

Stores code	Description	
001330Y	Tool for fitting steering seats	
001467Y002	Driver for OD 73 mm bearing	
001467Y006	Extraction pliers for 20 mm bearings	
001467Y007	Driver for OD 54 mm bearing	
001467Y008	Extraction pliers for ø 17 mm bearings	
001467Y014	Extraction pliers for ø 15 mm bearings	





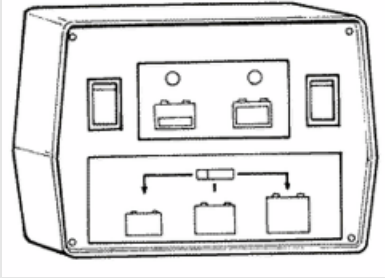





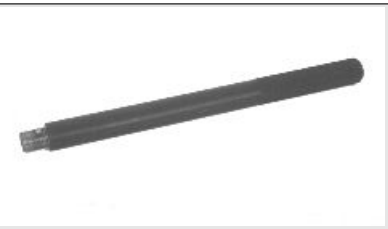
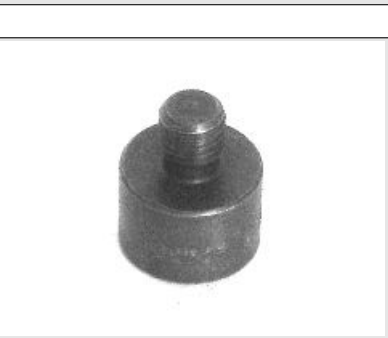

Stores code	Description	
001467Y031	Bell	
001467Y034	Extraction pliers for $\varnothing$ 15 mm bearings	
001467Y035	Bearing housing outside diameter 47 mm	
002465Y	Pliers for circlips	
006029Y	Punch for fitting fifth wheel seat on steering tube	
020004Y	Punch for removing fifth wheels from the headstock	
020055Y	Wrench for steering tube ring nut	
020150Y	Air heater support	





Stores code	Description	
020151Y	Air heater	
020193Y	Oil pressure gauge	
020201Y	Spacer bushing driving tube	
020262Y	Crankcase splitting strip	
020306Y	Punch for assembling valve seal rings	
020329Y	Mity-Vac vacuum operated pump	
020330Y	Stroboscopic light for timing control	







Stores code	Description	
020331Y	Digital multimeter	
020333Y	Single battery charger	
020334Y	Multiple battery charger	
020335Y	Magnetic support for dial gauge	
020357Y	32 x 35 mm adaptor	
020358Y	37x40 mm adaptor	
020359Y	42 x 47 mm adaptor	









Stores code	Description	
020360Y	52 x 55 mm adaptor	
020364Y	25 mm guide	
020376Y	Adaptor handle	
020382Y012 020412Y	bush (valve removing tool) 15 mm guide	
020424Y	Driven pulley roller casing fitting punch	
020431Y	Valve oil seal extractor	

Stores code	Description	
020434Y	Oil pressure control fitting	
020439Y	17 mm guide	
020444Y	Tool for fitting/ removing the driven pulley clutch	
020456Y	Ø 24 mm adaptor	
020458Y	Puller for lower bearing on steering tube	

Stores code	Description	
020459Y	Punch for fitting bearing on steering tube	
020460Y	Scooter diagnosis and tester	
020467Y	Flywheel extractor	
020468Y	Piston fitting band	
020469Y	Reprogramming kit for scooter diagnosis tester	

Stores code	Description	
020470Y	Pin retainers installation tool	 A set of three metal tools used for installing pin retainers. It includes a long cylindrical pin, a shorter cylindrical sleeve, and a handle with a threaded end for driving the pin into the sleeve.
020471Y	Pin for countershaft timing	 A single, long, cylindrical metal pin with a slightly tapered end, used for timing the countershaft.
020472Y	Flywheel lock wrench	 A large, heavy-duty metal wrench with a circular head and a long handle. It is used to lock the flywheel during engine work. A small cylindrical component is shown separately below the main tool.
020474Y	Driving pulley lock wrench	 A metal wrench with a curved, hook-like head and a long handle, used to lock the driving pulley.
020475Y	Piston position checking tool	 A complex metal tool with a circular base and several vertical pins of different heights, used to check the position of the piston.
020476Y	Stud bolt set	 A set of three long, cylindrical metal studs or bolts of varying lengths, used for securing components.

Stores code	Description	
020478Y	Punch for driven pulley roller casing	
020479Y	Countershaft lock wrench	
020480Y	Petrol pressure check set	
020481Y	Control unit interface wiring	
020482Y	Engine support	
020483Y	30 mm guide	



Stores code	Description
020512Y	Piston fitting fork



020527Y	Engine support base	
---------	---------------------	--

020604Y011	Fitting adapter	
020565Y	Flywheel lock calliper spanner	

Marelli MIU diagnosis software    Marelli MIU diagnosis software



020640y	software euro3	
---------	----------------	--



# INDEX OF TOPICS

**MAINTENANCE**

**MAIN**

Follow these steps to reset the service icons:

1. With the key set to OFF, hold down the "SET" button and turn the key to ON : the "BELT" and "SERVICE" icons start flashing.
2. Push the "CLOCK" button for less than 1 second and the icons are displayed sequentially. The icon selected remains ON and the other is no longer displayed.
3. Press the "CLOCK" button again for more than 3 seconds to reset the relative maintenance step and the icon is no longer displayed.

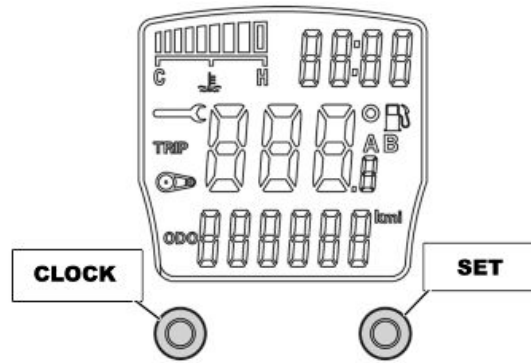

## Maintenance chart

### EVERY 2 YEARS

60'

#### Action

Coolant - change  
 Brake fluid - change

### AFTER 1,000 KM

60'

#### Action

Safety locks - check  
 Throttle lever - adjustment  
 Engine oil - change  
 Electrical system and battery - check  
 Coolant level - check  
 Brake fluid level - check  
 Engine oil - replacement  
 Brake pads - check condition and wear  
 Tyre pressure and wear - check  
 Vehicle and brake test - road test  
 Hub oil - change  
 Steering - check

### AFTER 5,000 KM; 25,000 KM; 35,000 KM; 55,000 KM; 65,000 KM

10'

#### Action

Engine oil - level check/top-up  
 Brake pads - check condition and wear  
 Centre stand - lubrication

**AFTER 10,000 KM; 50,000 KM; 70,000 KM****Action**

Safety locks - check
Driving belt - replacement
Throttle lever - adjustment
Air filter - clean
Engine oil - change
Electrical system and battery - check
Coolant level - check
Brake fluid level - check
Engine oil - replacement
Brake pads - check condition and wear
Sliding block / variable speed rollers - change
Tyre pressure and wear - check
Vehicle and brake test - road test
Hub oil - check
Suspensions - check
Steering - check
Centre stand - lubrication
Spark plugs - replacement
Tilt locking gripper control cable - adjustment
Parking control unit software upgrading (if available)

**AFTER 15,000 KM; 45,000 KM; 75,000 KM**

45'

**Action**

Engine oil - level check/top-up
Brake pads - check condition and wear
Centre stand - lubrication

**AFTER 20,000 KM; 40,000 KM; 60,000 KM AND 80,000 KM****Action**

Spark plugs - replacement
Driving belt - replacement
Throttle lever - adjustment
Air filter - check
Engine oil - change
Valve clearance - check
Electrical system and battery - check
Coolant level - check
Engine oil - replacement
Brake pads - check condition and wear
Sliding block / variable speed rollers - change
Tyre pressure and wear - check
Vehicle and brake test - road test
Hub oil - change
Suspensions - check
Steering - check
Centre stand - lubrication
Brake fluid level - check
Tilt locking gripper control cable - adjustment
Parking control unit software upgrading (if available)

**30,000 KM****Action**

Safety locks - check
Driving Belt - replacement
Throttle lever - adjustment
Air filter - cleaning
Engine oil - change
Electrical system and battery - check
Coolant level - check
Brake fluid level - check
Engine oil - replacement
Hub oil - check
Brake pads - check condition and wear
Sliding block / variable speed rollers - change
Tyre pressure and wear - check
Vehicle and brake test - road test
Suspensions - check
Steering - check
Centre stand - lubrication
Spark plugs - replacement
Tilt locking gripper control cable - adjustment
Parking control unit software upgrading (if available)

**Checking the spark advance**

The ignition advance is determined electronically on the basis of parameters known by the control unit. For this reason it is not possible to declare the reference values based on the engine rpm. The ignition timing value is detectable any time using the diagnostic tester. It is possible to check whether the ignition advance determined by the system does in fact correspond with the value actually activated on the engine, by means of the stroboscopic light.

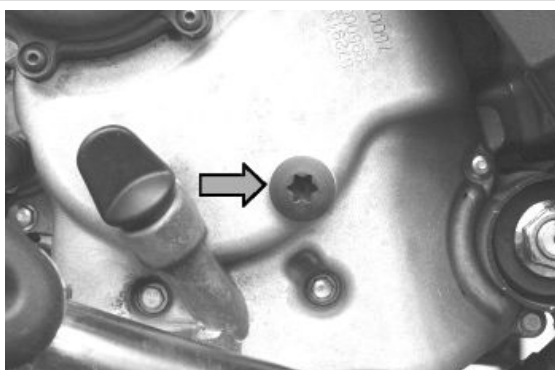

Proceed as follows:

- Remove the spark plugs.
- Remove the transmission crankcase.
- Rotate the driving pulley fan until the reference marks between the flywheel and flywheel cover meet as shown in the photograph.

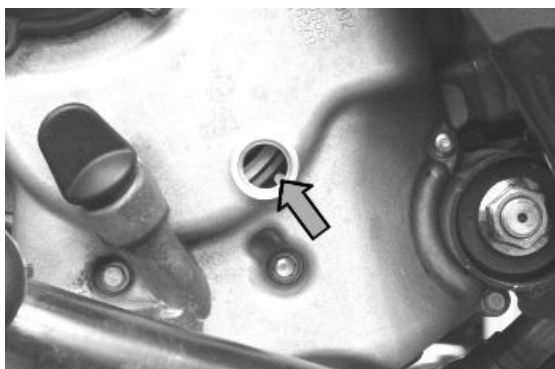

- Bring the reference mark onto the transmission side between the fan and the transmission cover as shown in the photograph.



- Refit the spark plugs.
- Refit the plastic cap on the flywheel cover.
- Adjust the spark gap to the contact position (no reference mark visible) and install it on engine between the spark plug and spark plug cap
- Connect the induction clamp to the spark gap cable respecting the proper polarity (the arrow on the clamp must be pointing at the spark plug).



- Connect the diagnostic tester.
- Start the engine.
- Select the menu on the "parameter" function.
- Select the stroboscopic light command in the traditional four-stroke engine position (1 spark 2 revs).
- Check that the real values of rpm and ignition advance match those measured using the diagnostic tester.



If the values do not correspond, check:

- distribution timing
- revolution-timing sensor
- Injection control unit

### Specific tooling

**020460Y Scooter diagnosis and tester**

**020330Y Stroboscopic light for timing control**

**020621Y H.V. cable extraction adapter**

## Spark plug

Remove the port on the left-hand side panel of the vehicle by undoing the fixing screw and using a small screwdriver in the rear recess shown in the figure, then do the following:

- Disconnect the HV wire caps «A» of the spark plugs;
- Unscrew the spark plugs using the wrench supplied;
- Upon refitting, place the spark plugs at the required angle and tighten by hand until it is finger tight;
- Use the wrench only for final tightening of the spark plug;
- Place cap «A» fully over the spark plugs
- Refit the port making sure the rear hook is inserted.

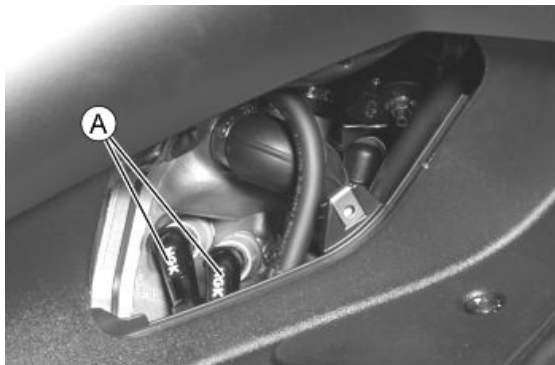

### WARNING



**THE SPARK PLUG MUST BE REMOVED WHEN THE ENGINE IS COLD. REPLACE THE SPARK PLUG AS INDICATED IN THE SCHEDULED MAINTENANCE TABLE. THE USE OF ELECTRONIC CENTRAL UNITS AND OF NON-COMPLIANT ELECTRONIC IGNITIONS OR SPARK PLUGS OTHER THAN THOSE PRESCRIBED MAY SERIOUSLY DAMAGE THE ENGINE.**

### N.B.

**THE USE OF SPARK PLUGS OTHER THAN THE INDICATED TYPE OR OF SHIELDLESS SPARK PLUG CAPS CAN CAUSE ELECTRICAL SYSTEM FAILURES.**

### Characteristic

#### Spark plug

CHAMPION RG 6 YC

#### Alternative spark plug

NGK CR7EKB

### Electric characteristic

#### Electrode gap

0.7 ÷ 0.8 mm



## Hub oil

### Check

- Park the vehicle on its centre stand on flat ground;
- Remove the oil dipstick «**A**», dry it with a clean cloth and put it back into its hole **tightening it completely**;

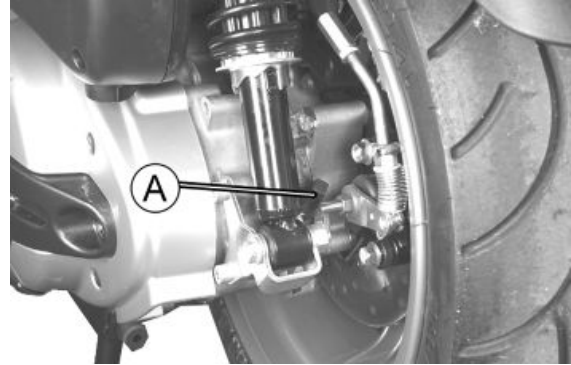

Remove the dipstick and check that the oil level is slightly over the second notch starting from the lower end; if the level is below the **MAX** mark, it needs to be filled up with the right amount of hub oil.

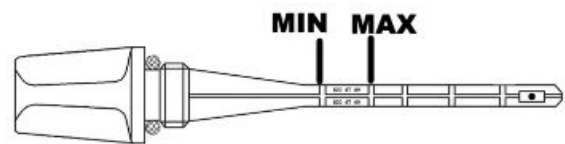

- Screw up the oil dipstick again and make sure it is locked properly into place.

### Replacement

- Remove the oil cap «**A**».
- Unscrew the oil drainage cap "**B**" and drain out all the oil.
- Screw in the drainage cap again and fill the hub with the prescribed oil.

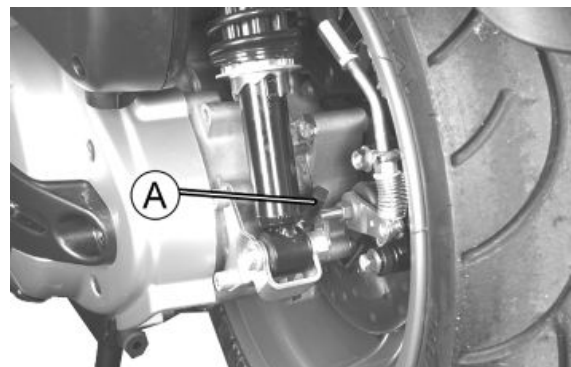

#### Recommended products

##### AGIP ROTRA 80W-90 Rear hub oil

SAE 80W/90 Oil that exceeds the requirements of API GL3 specifications

#### Characteristic

##### Rear hub oil

Capacity approximately 250 cc

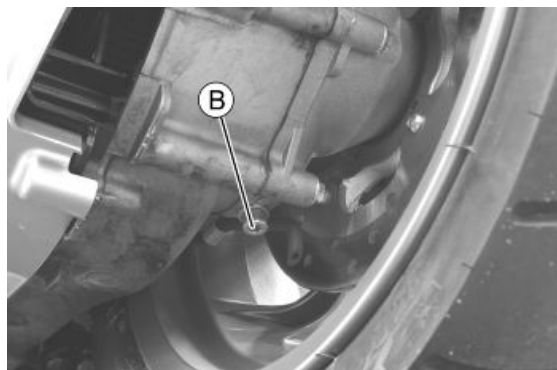

## Air filter

Proceed as follows:

Unscrew the nine fixing screws «A» and remove the air filter cover.

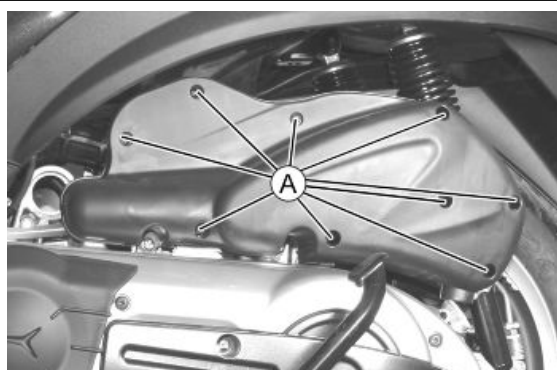

- Wash the sponge with water and mild soap.
- Dry it with a clean cloth and short blasts of compressed air.
- Soak it in a mixture of 50% petrol and 50% specified oil.
- Gently squeeze the filtering element with your hands but do not wring it; allow it to drip dry and then refit.

### CAUTION



**IF THE VEHICLE IS USED ON DUSTY ROADS IT IS NECESSARY TO CARRY OUT MAINTENANCE CONTROLS OF THE AIR FILTER TO AVOID DAMAGING THE ENGINE.**

### Recommended products

#### **AGIP FILTER OIL Oil for air filter sponge**

Mineral oil with specific additives for increased adhesiveness

## Engine oil

In 4T engines, the engine oil is used to lubricate the distribution elements, the bench bearings and the thermal group. **An insufficient quantity of oil can cause serious damage to the engine.**

In all 4T engines, the deterioration of the oil characteristics, or a certain consumption should be considered normal, especially if during the run-in period. Consumption levels in particular can be influenced by the conditions of use (e.g.: oil consumption increases when driving at "full throttle").

## Replacement

Replace oil and filter as indicated in the scheduled maintenance table. Empty the engine by draining the oil through drainage plug «**B**».

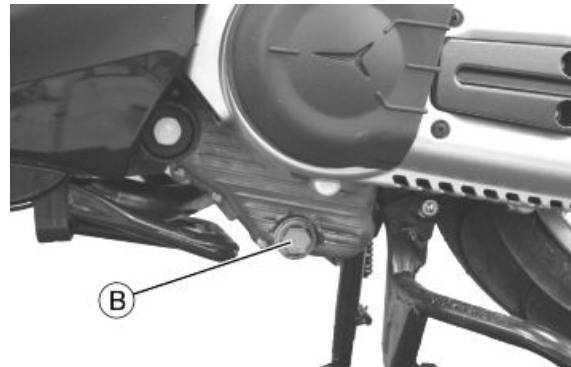

To facilitate oil drainage, loosen the cap/dipstick «**A**».

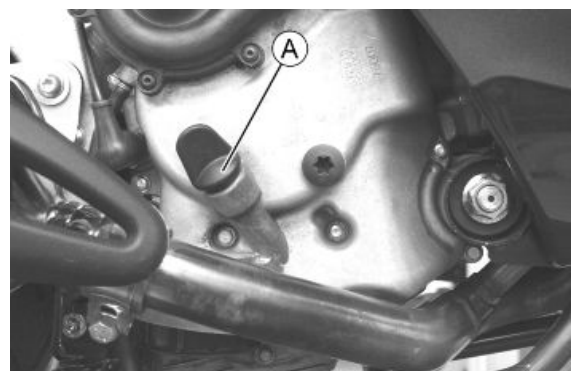

Once all the oil has drained through the drainage opening, unscrew and remove the oil cartridge filter «**C**».

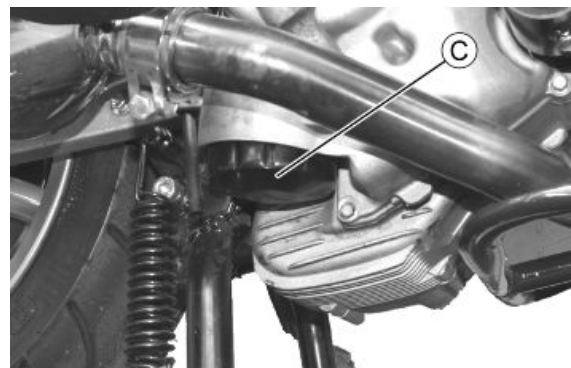

Make sure the pre-filter and discharge tap O-rings are in good condition.

Lubricate them and refit the mesh filter and oil drainage plug, screwing them up to the specified torque.

Refit the new cartridge filter being careful to lubricate the O-ring before fitting it.

Change the engine oil.

Since a certain quantity of oil still remains in the circuit, engine oil must be added through the plug «**A**». Then start up the scooter, leave it running for

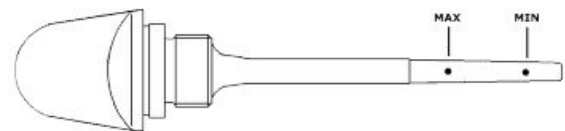

a few minutes and switch it off: after five minutes check the level and if necessary top up without exceeding the **MAX** level. The cartridge filter must be replaced every time the oil is changed. Use new oil of the recommended type for topping up and changing purposes.

**N.B.**

**THE ENGINE MUST BE HOT WHEN THE OIL IS CHANGED.**

**Recommended products****AGIP CITY HI TEC 4T Engine oil**

SAE 5W-40 Synthetic oil that exceed the requirements of API SL, ACEA A3, JASO MA specifications

**Locking torques (N\*m)**

**Engine oil filter 12 - 16 Engine oil drainage plug 24 ÷ 30**

---

**Check**

This operation must be carried out with the engine cold and following the procedure below:

- Place the vehicle on its centre stand and on flat ground.
- Unscrew the cap/dipstick "A", dry it with a clean cloth and reinsert it, **screwing it all the way down.**
- Remove the cap/dipstick again and check that the level is between the min and max reference marks; top up, if required.

If the check is carried out after the vehicle has been used, and therefore with a hot engine, the level line will be lower; in order to carry out a correct check, wait at least 10 minutes after the engine has been stopped so as to get the correct level.

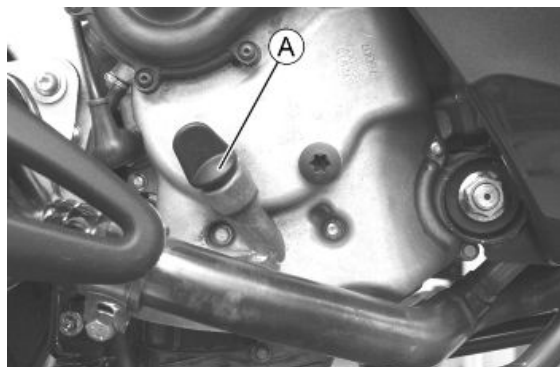

### Oil top up

The oil should be topped up after having checked the level and in any case by adding oil **without ever exceeding the MAX. level.**

Restoring the level from the **MIN** to the **MAX** marks requires approx. **400 m<sup>3</sup>** of oil.

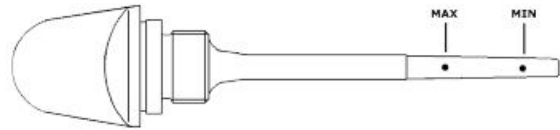

### Engine oil filter

The cartridge filter must be replaced every time the oil is changed. Use new oil of the recommended type for topping up and changing purposes.

Make sure the pre-filter and discharge tap O-rings are in good condition. Lubricate them and refit the mesh filter and oil drainage plug, screwing them up to the specified torque. Refit the new cartridge filter being careful to lubricate the O-ring before the fitting. Change the engine oil.

#### Recommended products

##### AGIP CITY HI TEC 4T Engine oil

SAE 5W-40 Synthetic oil that exceed the requirements of API SL, ACEA A3, JASO MA specifications

### Oil pressure warning light

The vehicle is equipped with a warning light on the instrument panel that lights up when the key is turned to the "ON" position. However, this light should switch off once the engine has been started.

**If the light turns on during braking, at idling speed or while turning a corner, it is necessary to check the oil level and the lubrication system.**

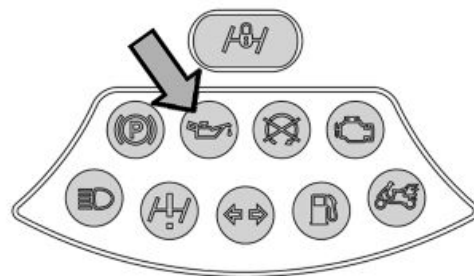

## Checking the ignition timing

-Remove the plastic cap on the flywheel cover  
 - Turn the flywheel until the reference mark «T» on the rotor matches the reference mark on the flywheel cover as shown in the figure (TDC). Make sure that the 4V reference point on the camshaft control pulley is aligned with the reference point on the head as shown in the second figure. If the reference is opposite the indicator on the head, turn the crankshaft once more.

For the use of this reference mark, remove the spark plug and turn the engine in the direction that is the reverse of the normal direction using a calliper spanner applied to the camshaft command pulley casing.

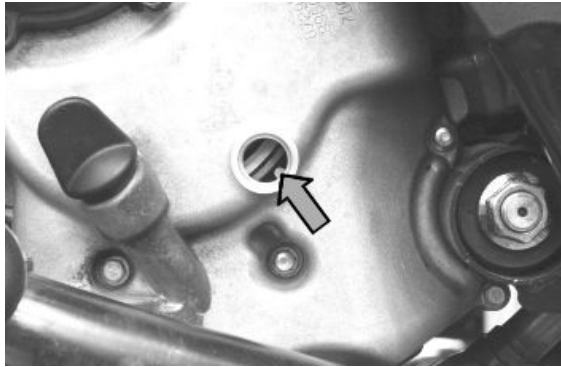

## Cooling system

### Adding engine coolant.

Check coolant level when the engine is cold as indicated in the scheduled maintenance table, following the steps below:

Place the scooter on its centre stand and on flat ground.

- Undo the screw shown in the figure and remove the expansion tank cap on RHS.

- Top up if the fluid level is near or below the MIN level edge. The liquid level must always be between the MIN and MAX level.

-The coolant consists of an ethylene glycol and corrosion inhibitor based 50% de-ionised water-antifreeze solution mix.

#### CAUTION

**DO NOT EXCEED THE MAX. LEVEL WHEN FILLING SO AS TO AVOID THE COOLANT ESCAPING FROM THE EXPANSION TANK WHEN THE vehicle IS IN USE.**

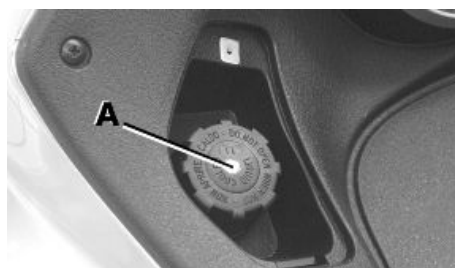

### Recommended products

#### AGIP PERMANENT SPEZIAL Coolant

Monoethylene glycol based antifreeze solution,  
CUNA NC 956-16

## Braking system

### Level check

The front and rear brake fluid reservoirs are both positioned on the handlebars. Proceed as follows:

- Rest the vehicle on its centre stand with the handlebars perfectly horizontal;
- Check the fluid level through the sight glass «C». A certain lowering of the level is caused by wear on the pads.



### Top-up

Proceed as follows: Loosen the two fixing screws and remove the reservoir cover; top-up with the recommended fluid only without exceeding the 'MAX' mark.

This procedure applies to the rear brake pump top-up operation; follow the same procedure for the front brake pump.

Under standard climatic conditions, replace coolant as indicated in the scheduled maintenance table.

#### WARNING



**ONLY USE DOT 4 CLASS BRAKE FLUIDS. COOLING SYSTEM FLUIDS ARE HIGHLY CORROSIVE. MAKE SURE THAT IT DOES NOT COME INTO CONTACT WITH THE PAINTWORK.**

#### CAUTION

**MAKE SURE THE BRAKE FLUID DOES NOT GET INTO YOUR EYES OR ON YOUR SKIN OR CLOTHES. IF THIS HAPPENS ACCIDENTALLY, WASH WITH WATER.**

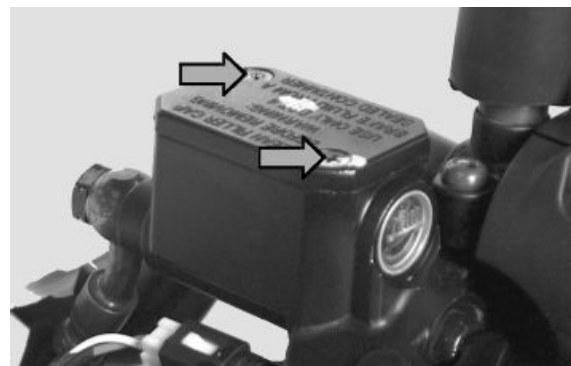

### Recommended products

#### AGIP BRAKE FLUID DOT4 Brake fluid

FMVSS DOT4 Synthetic fluid

## Headlight adjustment

Proceed as follows:

- Position the unloaded vehicle, in running order and with the tyres inflated to the prescribed pressure, onto a flat surface 10 m away from a half-lit white screen; make sure the vehicle axis is perpendicular to the screen.
- Remove the headlight assembly central cover.
- Turn on the headlight and check that the borderline of the projected light beam should be lower than  $\frac{9}{10}$  of the distance from the ground to the centre of the vehicle's headlight, and higher than  $\frac{7}{10}$ .
- Otherwise, adjust the headlight.

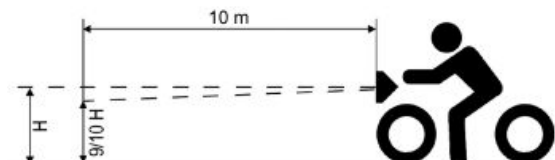

#### N.B.

**THE ABOVE PROCEDURE COMPLIES WITH THE EUROPEAN STANDARDS REGARDING MAXIMUM AND MINIMUM HEIGHT OF LIGHT BEAMS. REFER TO THE STATUTORY REGULATIONS IN FORCE IN EVERY COUNTRY WHERE THE vehicle IS USED.**

To access the headlight adjusting screws:

- Unscrew the four screws «A» (two on each side) and remove the front cowl.
- Unscrew the four screws «B» and remove the side cover.

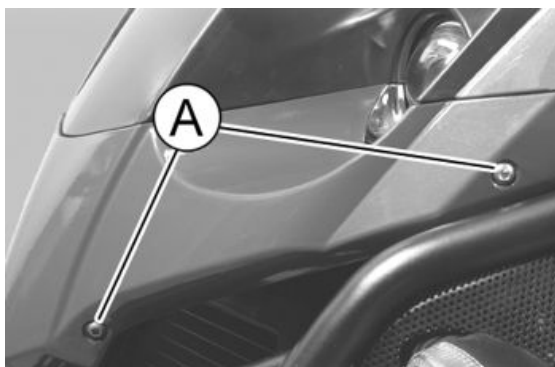



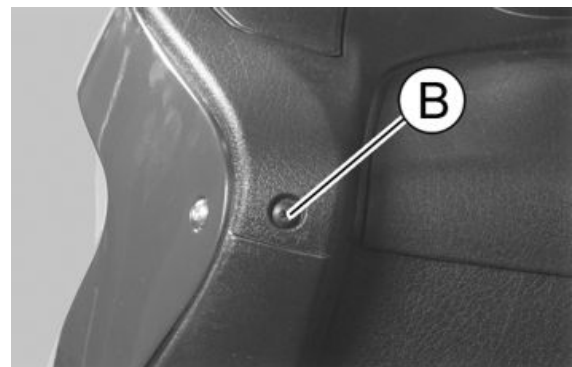
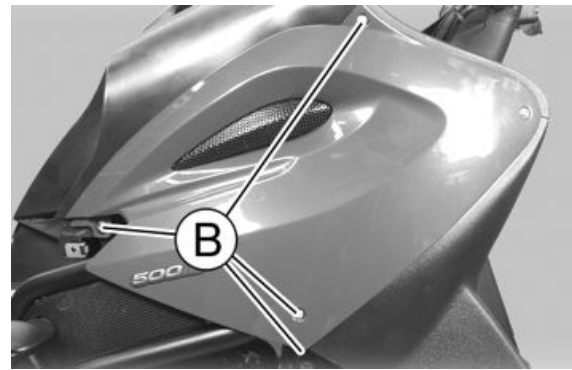

Each bulb has two light beam adjusting screws, one for horizontal adjustment «C» and one for the vertical adjustment «D». Adjust one headlamp at a time. In order to do that, remove the connector from the other bulbs so that you can adjust one headlamp at a time.

**N.B.**

**THE HEADLAMPS CAN ONLY BE LIT WHEN THE ENGINE IS ON. ADJUST THE LIGHT BEAM IN A WELL VENTILATED PLACE.**

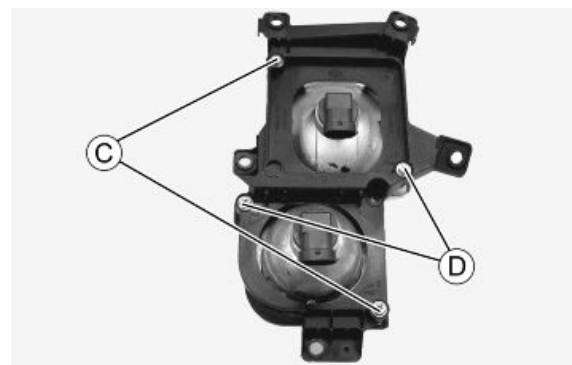



## INDEX OF TOPICS

TROUBLESHOOTING

TROUBL

This section makes it possible to find the solutions to use in troubleshooting.

For each breakdown, a list of the possible causes and respective interventions is given.

## Engine

### Excessive oil consumption/Exhaust smoke

#### EXCESSIVE CONSUMPTION

Possible Cause	Operation
Wrong valve adjustment	Adjust the valve clearance properly
Overheated valves	Remove the head and the valves, grind or replace the valves
Misshapen/worn valve seats	Replace the head assembly
Worn cylinder, Worn or broken piston rings	Replace the piston cylinder assembly or piston rings
Worn or broken piston rings or piston rings that have not been fitted properly	Replace the piston cylinder unit or just the piston rings
Oil leaks from the couplings or from the gaskets	Check and replace the gaskets or restore the coupling seal
Worn valve oil guard	Replace the valve oil guard
Worn valve guides	Check and replace the head unit if required

### Insufficient lubrication pressure

#### POOR LUBRICATION PRESSURE

Possible Cause	Operation
By-Pass remains open	Check the By-Pass and replace if required. Carefully clean the By-Pass area.
Oil pump with excessive clearance	Perform the dimensional checks on the oil pump components
Oil filter too dirty	Replace the cartridge filter
Oil level too low	Restore the level adding the recommended oil type

### Transmission and brakes

### Clutch grabbing or performing inadequately

#### IRREGULAR CLUTCH PERFORMANCE OR SLIPPAGE

Possible Cause	Operation
Faulty clutch	Check that there is no grease on the masses. Check that the clutch mass contact surface with the casing is mainly in the centre with equivalent characteristics on the three masses. Check that the clutch casing is not scored or worn in an anomalous way

## Insufficient braking

### **INEFFICIENT BRAKING SYSTEM**

Possible Cause	Operation
Inefficient braking system	Check the pad wear (1.5 min). Check that the brake discs are not worn, scored or warped. Check the correct level of fluid in the pumps and replace brake fluid if necessary. Check there is no air in the circuits; if necessary, bleed the air. Check that the front brake calliper moves in axis with the disc.
Fluid leakage in hydraulic braking system	Failing elastic fittings, plunger or brake pump seals, replace
Brake disc slack or distorted	Check the brake disc screws are locked; measure the axial shift of the disc with a dial gauge and with wheel mounted on the scooter.

## Brakes overheating

### **BRAKES OVERHEATING**

Possible Cause	Operation
Defective sliding of pistons	Check calliper and replace any damaged part.
Brake disc slack or distorted	Check the brake disc screws are locked; use a dial gauge and a wheel mounted on the vehicle to measure the axial shift of the disc.
Clogged compensation holes on the pump	Clean carefully and blast with compressed air
Re-inflated or glued rubber gaskets	Replace gaskets.

## Steering and suspensions

### Heavy steering

#### **STEERING HARDENING**

Possible Cause	Operation
Steering hardening	Check the tightening of the top and bottom ring nuts. If irregularities continue in turning the steering even after making the above adjustments, check the seats in which the ball bearings rotate: if they are recessed or if the balls are squashed, replace them.

### Excessive steering play

#### **EXCESSIVE STEERING CLEARANCE**

Possible Cause	Operation
Torque not conforming	Check the tightening of the top and bottom ring nuts. If irregularities continue in turning the steering even after making the above adjustments, check the seats in which the ball bearings rotate:

**Possible Cause**

**Operation**

if they are recessed or if the balls are squashed, replace them.

**Noisy suspension**

**NOISY SUSPENSION**

**Possible Cause**

**Operation**

Malfunctions in the suspension system

If the front suspension is noisy, check: the efficiency of the front shock absorbers; the condition of the ball bearings and relevant lock-nuts, the limit switch rubber buffers and the movement bushings. In conclusion, check the tightening torque of the wheel hub, the brake calliper, the shock absorber disk in the attachment to the hub and the steering tube.

**Suspension oil leakage**

**OIL LEAKAGE FROM SUSPENSION**

**Possible Cause**

**Operation**

Seal fault or breakage

Replace the shock absorber Check the condition of wear of the steering covers and the adjustments.

## INDEX OF TOPICS

ELECTRICAL SYSTEM

ELE SYS

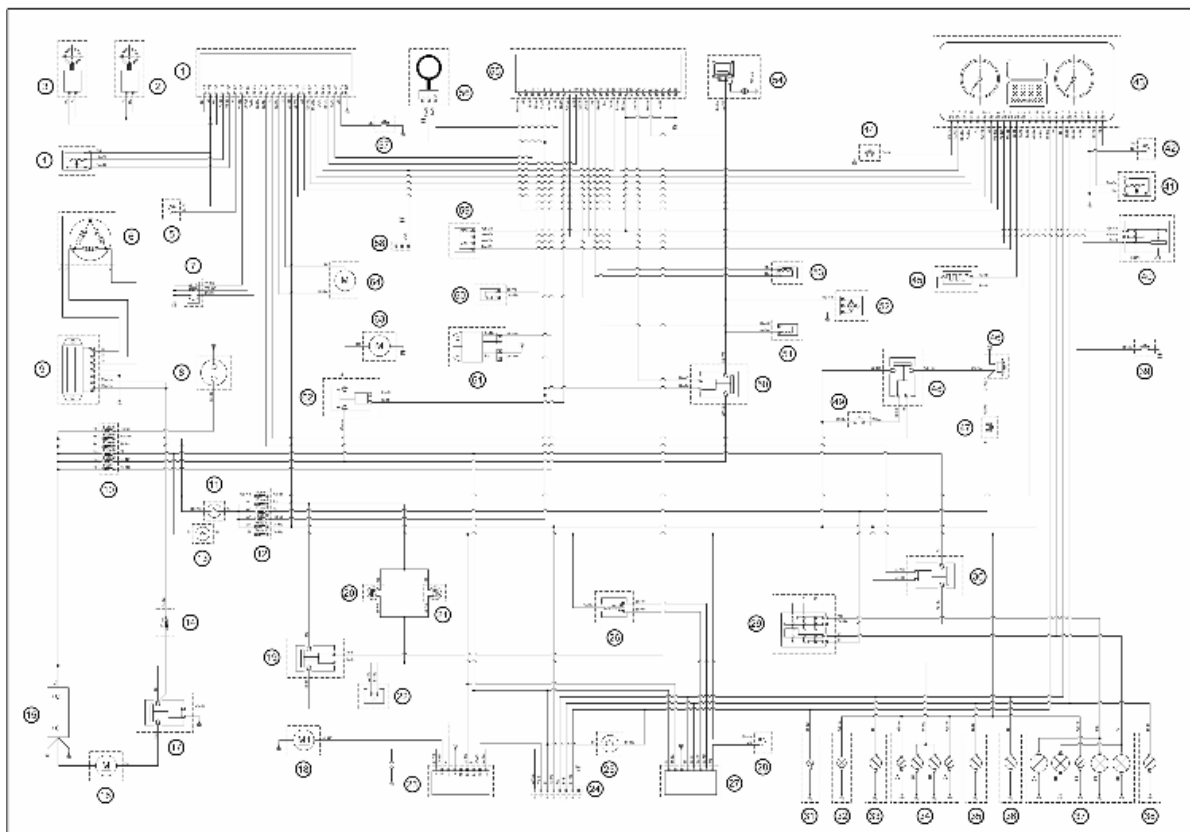
**KEY**

1. Parking electronic control unit
2. Right speed sensor
3. Left speed sensor
4. Potentiometer
5. Rider presence sensor
6. Magneto flywheel
7. Locking/unlocking switch
8. LV socket
9. Voltage regulator
10. Main fuses
11. Key switch contacts
12. Auxiliary fuses
13. Key switch contacts
14. Fuse
15. Battery
16. Starter motor
17. Start-up remote control switch
18. Saddle opening actuator
19. Start-up enabling remote control



20. Stop button on rear brake
21. Stop button on front brake
22. Starter button
23. Saddle opening receiver
24. Wiring for antitheft device
25. Helmet compartment light switch
26. Turn indicator switch
27. Turn signal command device
28. Hazard button
29. Light switch
30. Headlight remote control
31. Helmet compartment light bulb
32. License plate light bulb
33. Rear left turn indicator
34. Rear light
  - A. Tail light bulbs
  - B. Stop light bulbs
35. Rear right turn indicator
36. Front left turn indicator
37. Headlight
  - A. Left low-beam light bulb
  - B. Left high-beam light bulb
  - C. Tail light bulb
  - D. Right low-beam light bulb
  - E. Right high-beam light bulb
38. Front right turn indicator
39. Oil pressure sensor
40. Engine stop switch
41. Fuel level transmitter
42. MODE button
43. Instrument panel
44. Hand brake
45. External temperature sensor
46. Horn
47. Horn button
48. Horn remote control
49. Pressure sensor
50. Injection load remote control

- 51. Injector
- 52. Fuel pump
- 53. Revolution sensor
- 54. HV coil
- 55. Injection ECU
- 56. Immobilizer aerial
- 57. Brake calliper sensor
- 58. Diagnosis connector
- 59. Coolant temperature sensor
- 60. Lambda probe
- 61. MIU control unit power device
- 62. Electric fan remote control
- 63. Electric fan
- 64. Geared motor

**Key**

**Ar:** Orange **Az:** Sky blue **Bi:** White **Bl:** Blue **Gi:** Yellow **Gr:** Grey

**Ma:** Brown **Ne:** Black **Ro:** Pink **Rs:** Red **Ve:** Green **Vi:** Purple

**Components arrangement**



1. Relays for lights/ horn/ injection load/ electric fan: remove the front shield to reach these relays.

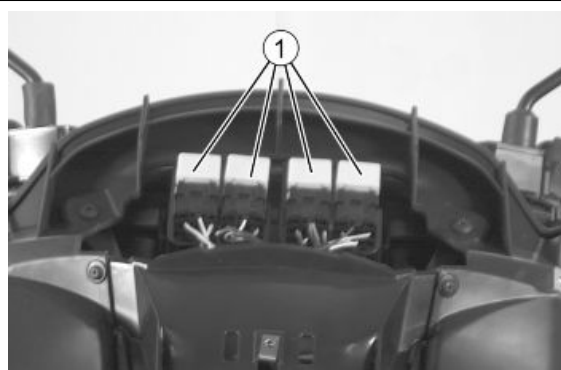

2 - Auxiliary fuses: remove the footrest flap to reach these fuses.



**3 / 4 / 19** - Electronic control unit for injection (MIU) / Start-up relay / Start-up enabling switch relay: remove the lid of the helmet compartment to reach these relays.

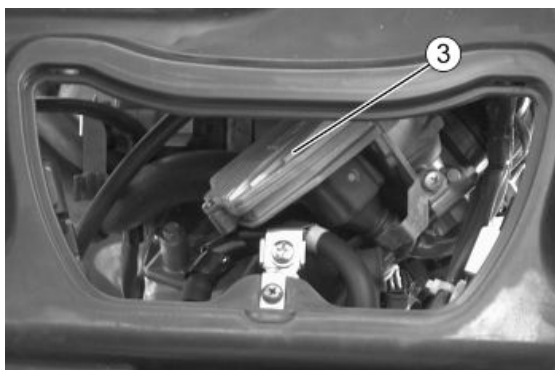

**5 - 6**. Fuel pump / Fuel level sensor: remove the central chassis cover to reach these components.

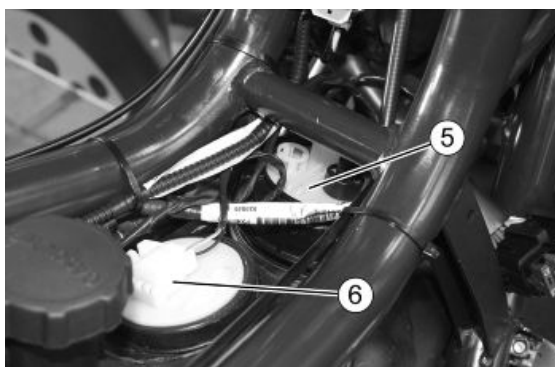

**10.**Coil: remove the helmet compartment to reach it;

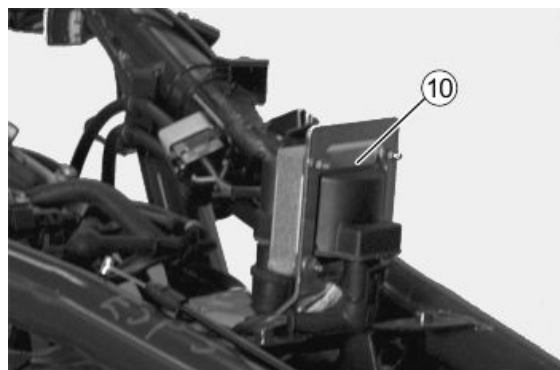

**7 -** Voltage regulator: remove the right side panel to reach it.

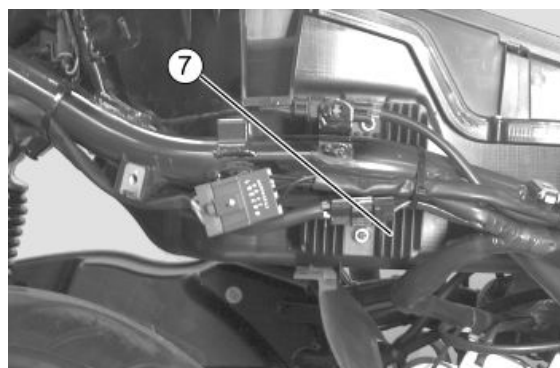

**8 -** Immobilizer: remove the shield back plate.

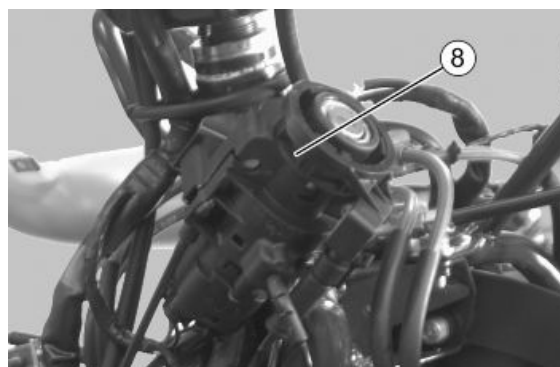

**9 / 18 -** Saddle opening receiver/ Turn indicator control device: remove the left fairing to reach them;

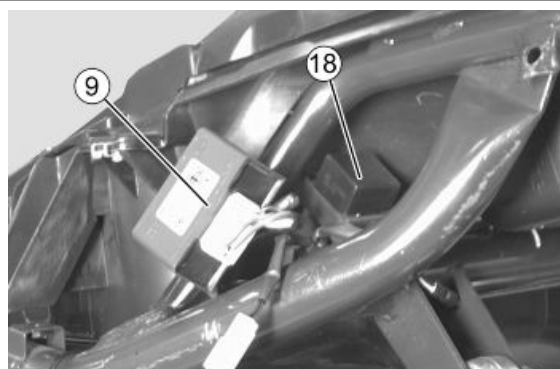

**11 / 12** - Diagnostics socket/ main fuses: these components are found in the helmet compartment.

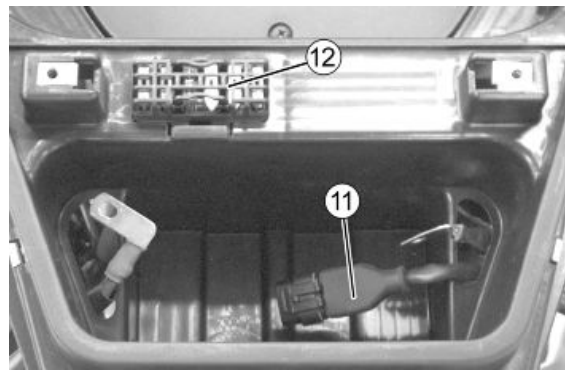

**13** - Lambda probe: The lambda probe is mounted on the exhaust manifold.

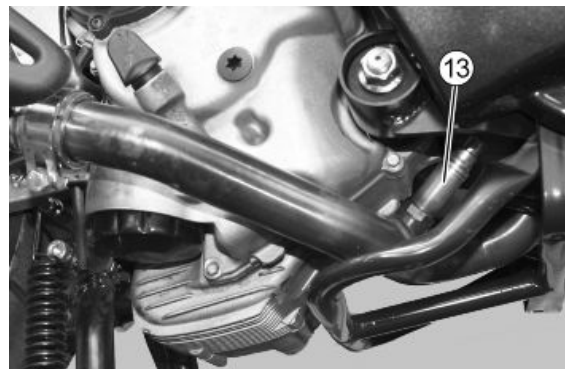

**14** - Engine oil pressure sensor: remove the exhaust end to reach it.

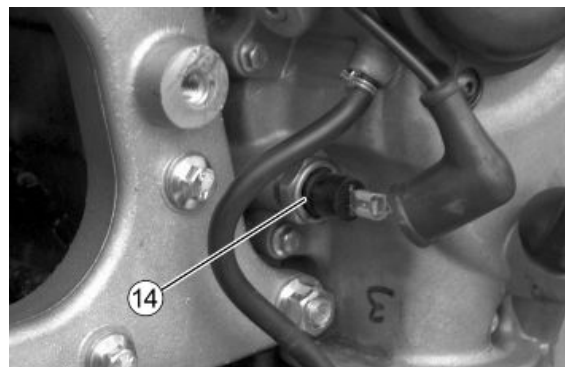

**15** - Parking control unit: remove the front shield to reach it.



**16** - Rider presence sensor: open the saddle and remove the cover to reach the rider presence sensor.

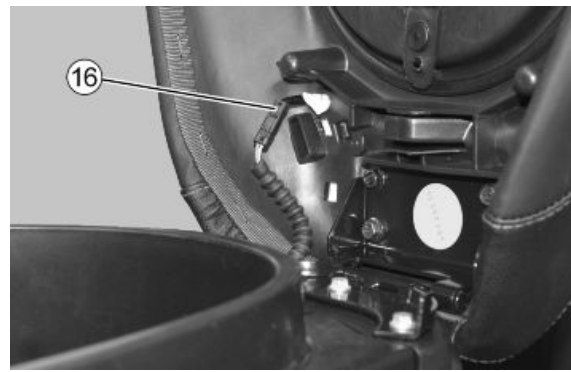

**17** - Coolant temperature sensor: remove the lid of the helmet compartment and disconnect the connector to reach it.



**20** - Horn: remove the shield back plate lower side to reach it.

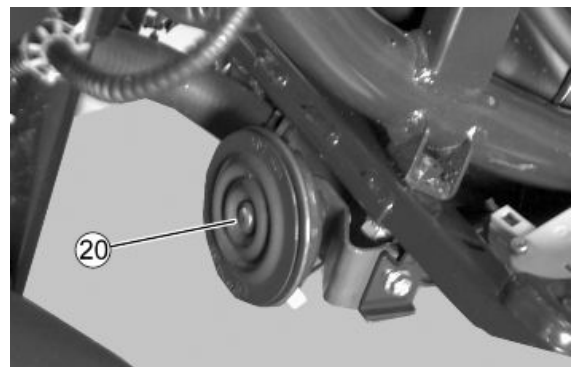

**21 - 22.** Plug socket/helmet compartment light: open the saddle to reach it.

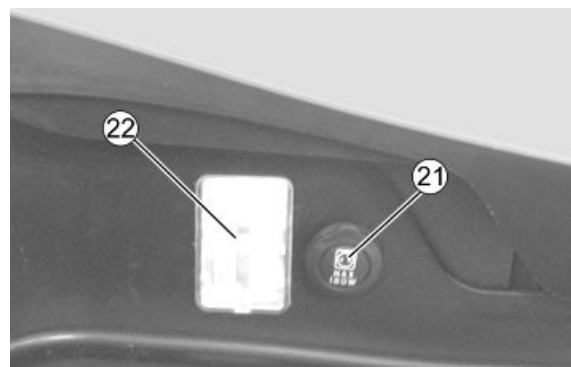

## Conceptual diagrams

## Ignition

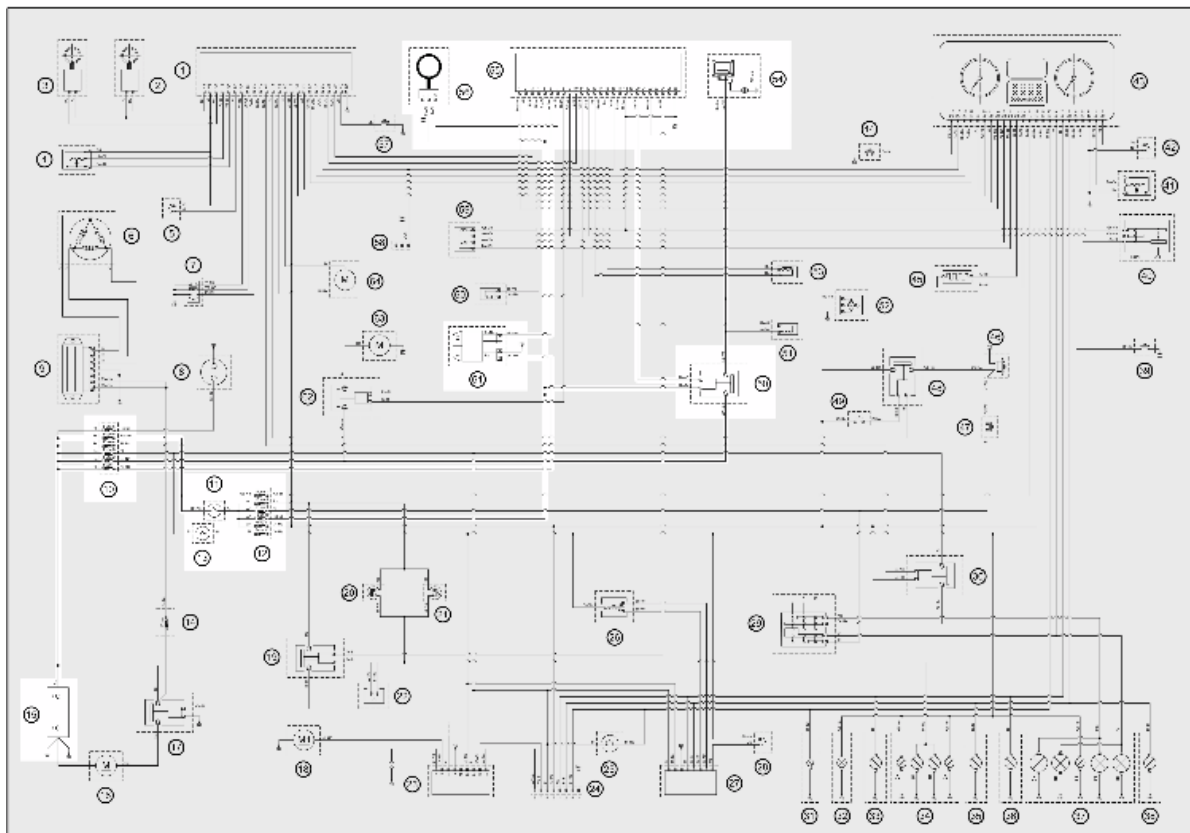

### KEY

- 10. Main fuses
- 11. Key switch contacts
- 12. Auxiliary fuses
- 15. Battery
- 50. Injection load remote control
- 54. HV coil
- 55. Injection ECU
- 56. Immobilizer aerial
- 61. MIU control unit power device



## Battery recharge and starting

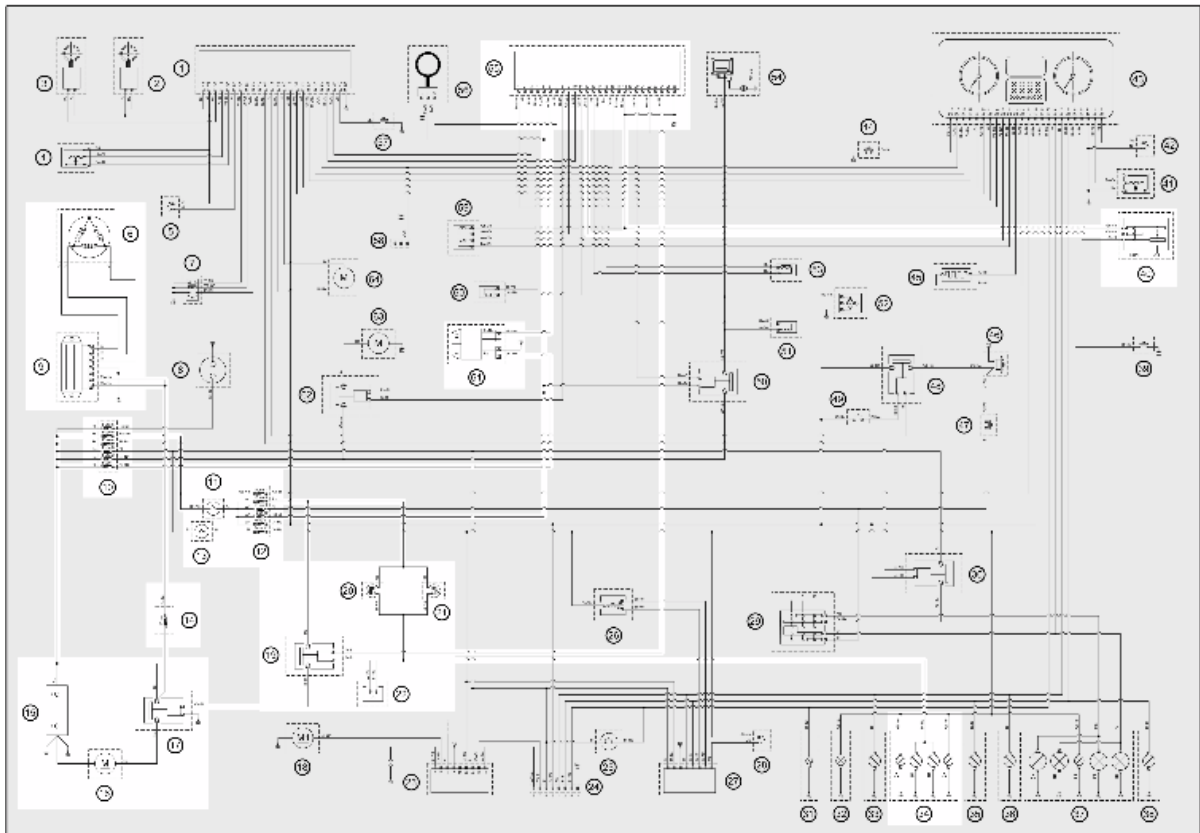

### KEY

- 6. Magneto flywheel
- 9. Voltage regulator
- 10. Main fuses
- 11. Key switch contacts
- 12. Auxiliary fuses
- 14. Fuse
- 15. Battery
- 16. Starter motor
- 17. Start-up remote control switch
- 19. Start-up enabling remote control
- 20. Stop button on rear brake
- 21. Stop button on front brake
- 22. Starter button
- 34. Rear light
- B. Stop light bulbs
- 40. Engine stop switch
- 55. Injection ECU

## 61. MIU control unit power device

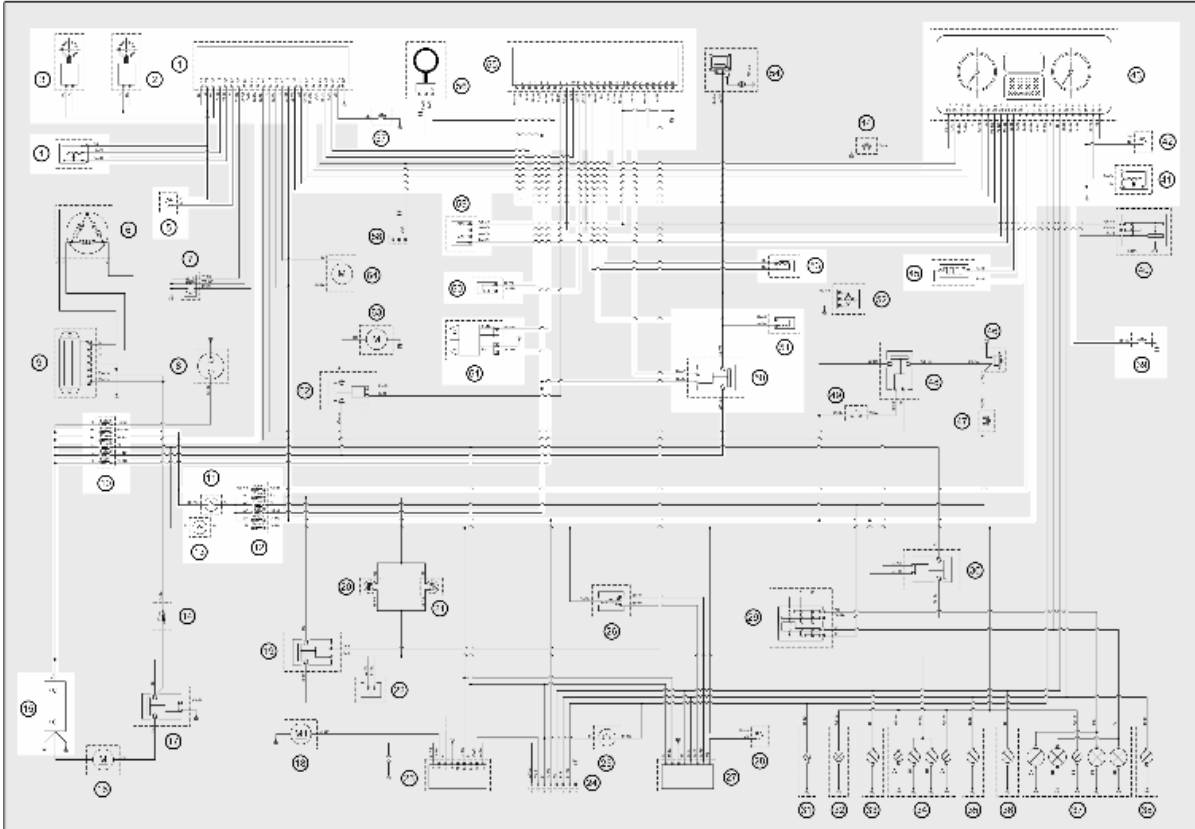
**Level indicators and enable signals section****KEY**

- 1. Parking electronic control unit
- 2. Right speed sensor
- 3. Left speed sensor
- 4. Potentiometer
- 5. Rider presence sensor
- 10. Main fuses
- 11. Key switch contacts
- 12. Auxiliary fuses
- 15. Battery
- 39. Oil pressure sensor
- 41. Fuel level transmitter
- 42. MODE button
- 43. Instrument panel
- 45. External temperature sensor
- 50. Injection load remote control
- 51. Injector

- 53. Rpm sensor
- 55. Injection ECU
- 56. Immobilizer aerial
- 57. Brake calliper sensor
- 59. Coolant temperature sensor
- 60. Lambda probe
- 61. MIU control unit power device

## Devices and accessories

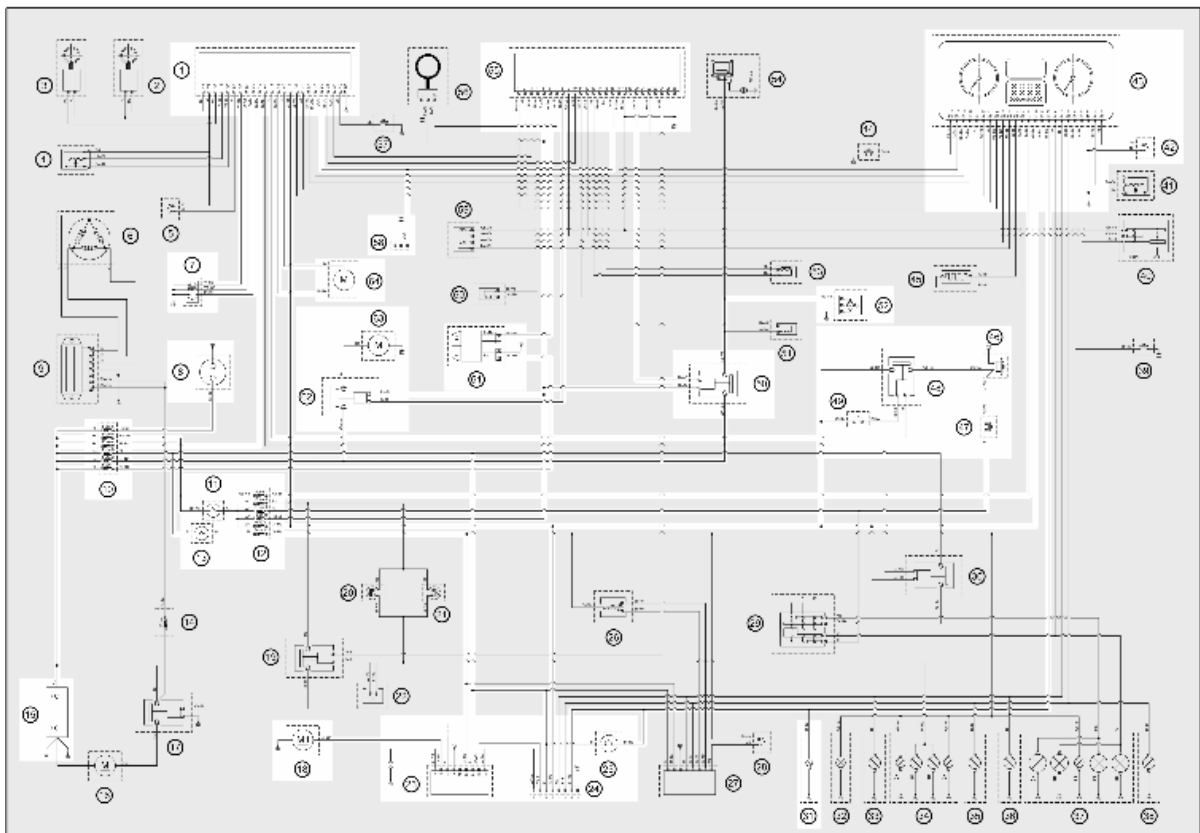

### KEY

- 1. Parking electronic control unit
- 7. Locking/unlocking switch
- 8. LV socket
- 10. Main fuses
- 11. Key switch contacts
- 12. Auxiliary fuses
- 13. Key switch contacts
- 15. Battery
- 18. Saddle opening actuator
- 23. Saddle opening receiver

- 24. Wiring for antitheft device
- 25. Helmet compartment light switch
- 31. Helmet compartment light bulb
- 42. MODE button
- 43. Instrument panel
- 46. Horn
- 47. Horn button
- 48. Horn remote control
- 49. Pressure sensor
- 50. Injection load remote control
- 52. Fuel pump
- 55. Injection ECU
- 58. Diagnosis connector
- 61. MIU control unit power device
- 62. Electric fan remote control
- 63. Electric fan
- 64. Geared motor

## Lights and turn indicators

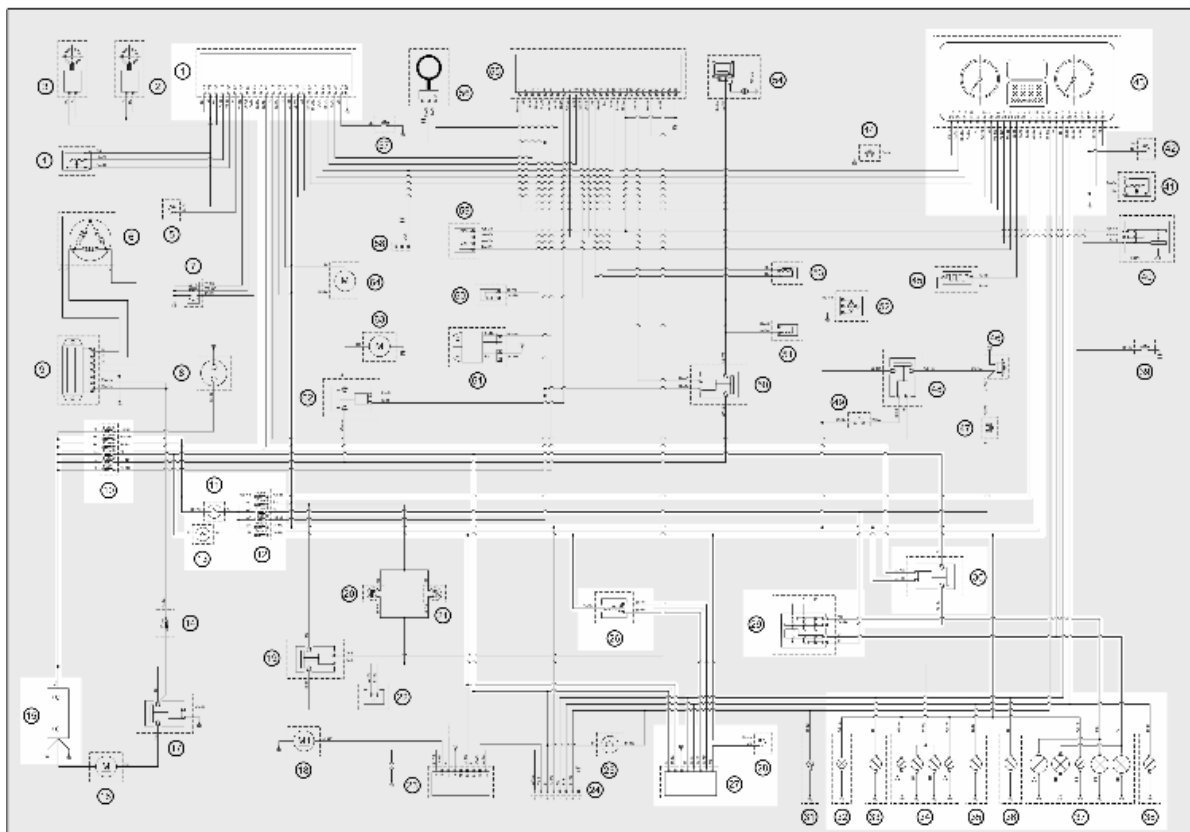

### KEY

- 1. Parking electronic control unit
- 10. Main fuses
- 11. Key switch contacts
- 12. Auxiliary fuses
- 13. Key switch contacts
- 15. Battery
- 26. Turn indicator switch
- 27. Turn signal command device
- 28. Hazard button
- 29. Light switch
- 30. Headlight remote control
- 32. License plate light bulb
- 33. Rear left turn indicator
- 34. Rear light
  - A. Tail light bulbs
- 35. Rear right turn indicator
- 36. Front left turn indicator
- 37. Headlight
  - A. Left low-beam light bulb
  - B. Left high-beam light bulb
  - C. Tail light bulb
  - D. Right low-beam light bulb
  - E. Right high-beam light bulb
- 38. Front right turn indicator
- 43. Instrument panel

---

## **Checks and inspections**

This section is devoted to the checks on the electrical system components.

---

---

## Immobiliser

The electronic ignition system is controlled by the control unit with the integrated Immobilizer system. The immobilizer is an antitheft system that allows the vehicle to be operated only when it is started with coded keys recognised by the control unit. The code is integrated in a transponder in the key block. This allows the driver clear operation without having to do anything other than just turning the key. The Immobiliser system consists of the following components:

- electronic control unit
- immobilizer aerial
- Master key with incorporated transponder (red key)
- service key with incorporated transponder (black key)
- HV coil
- Diagnosis LED

The diagnosis LED also works as a blinking light to deter theft. This function is activated every time the key switch is set to «**OFF**» or the engine emergency cut-off switch is set to «**OFF**». It remains activated for 48 hours in order not to affect the battery charge. When the ignition switch is turned to «**ON**» the deterring blinker function is deactivated. Subsequently, a flash confirms the switching to «**ON**». The duration of the flash depends on the programming of the electronic control unit. If the LED is off regardless of the position of the ignition-key switch and/or the instrument panel is not initiated, check if:

- there is battery voltage
- fuses 1-7-10-11 are in working order
- there is power to the control unit as specified below:

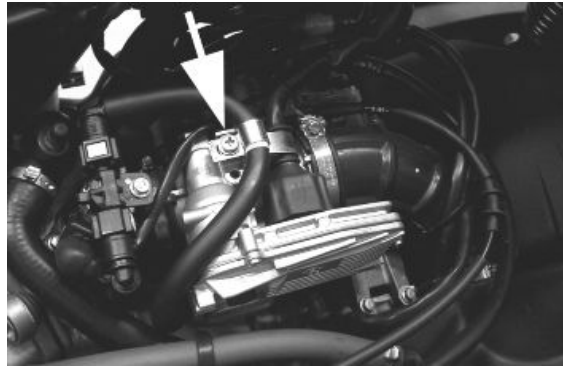

Remove the connector support bracket shown in the photograph and disconnect the connector from the control unit. Check the following conditions:

**With the key switch set to OFF:**

- if there is battery voltage between terminals 6-26 and terminal 6-chassis ground (fixed power supply). If there is no voltage check that fuse 1 and its cable are in working order.

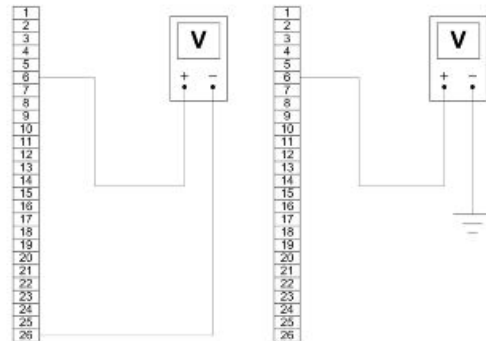

**With the key switch in the OFF position:**

- there is battery voltage between terminals 5-26 and terminal 5-frame earth (fixed power supply). If there is no voltage, check the key switch contacts, that fuse no. 10 and its cable are working order.

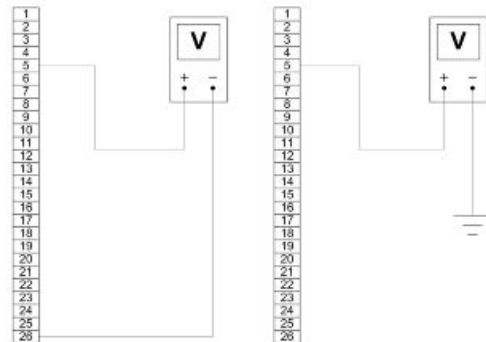

- There is continuity between terminals 12-18 with the emergency cut-off switch in the RUN position. If there is no continuity check the contacts of the switch.

If no faults are found, replace the electronic control unit.

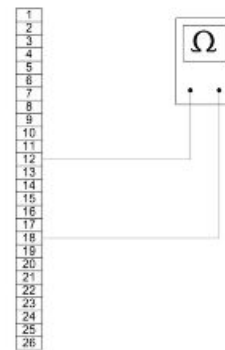

After removing the shield back plate, remove the electrical connection from the aerial as shown in the photograph



Remove the protective base from the connector.



With the ignition key switch at ON check there is battery voltage between the Red-White and Black cables

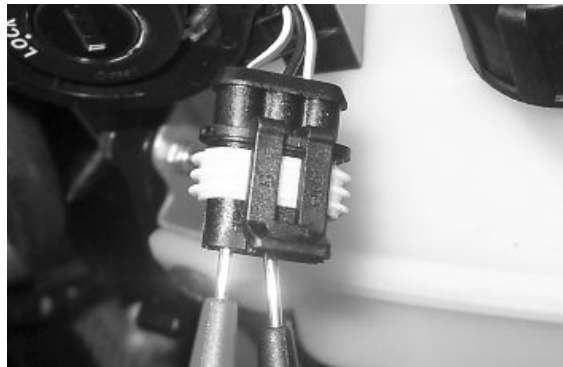

With MIU connector disconnected check the continuity between the Orange-White cable and pin 7 of the interface wiring .

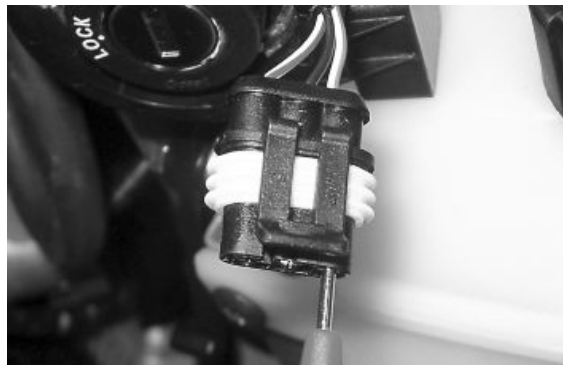

### Specific tooling

**020481Y Control unit interface wiring**

**020331Y Digital multimeter**

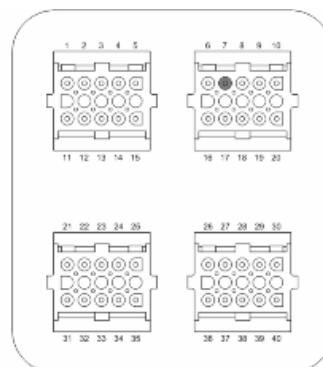

## Virgin circuit

When the ignition system is not encrypted, any key will start the engine but limited to 2000 rpm. The keys can only be recognised if the control unit has been programmed properly. The data storage procedure for a previously not programmed control unit provides for the recognition of the master as the



first key to be stored to memory: this becomes particularly important because it is the only key that enables the control unit to be wiped clean and reprogrammed for the memorisation of the service keys.

The master and service keys must be used to code the system as follows:

- Insert the Master key, turn it to «ON» and keep this position for two seconds (lower and upper limits 1 to 3 seconds).
- Insert the service key and turn it to «ON» for 2 seconds.
- If you have copies of the key, repeat the operation with each key.
- Insert the MASTER key again and turn it to «ON» for 2 seconds.

The maximum time to change keys is 10 seconds.

A maximum of 7 service keys can be programmed at one time.

It is essential to adhere to the times and the procedure. If you do not, start again from the beginning. Once the system has been programmed, the master key transponder is strictly matched with the control unit. With this link established, it is now possible to encode new service keys, in the event of losses, replacements, etc. Each new programming deletes the previous one so, in order to add or eliminate keys, you must repeat the procedure using all the keys you intend to keep using. If a service key should become un-coded, the efficiency of the high voltage circuit shielding must be thoroughly inspected: In any case it is advisable to use resistive spark plugs.

### Characteristic

#### MASTER key:

RED KEY

#### SERVICE key.

BLACK KEY

## Diagnostic codes

The immobiliser system is tested each time the ignition-key switch is turned from OFF to ON. During this diagnosis phase a number of control unit statuses can be seen and various light codes displayed. Regardless of the code transmitted, if at the end of the diagnosis the led remains off permanently, the ignition is enabled. If, however, the led remains on permanently, it means the ignition is inhibited:

**1. Previously unused control unit - key inserted:** a single 2 second flash is displayed, after which the LED remains off permanently. The keys can be stored to memory, the vehicle can be star-

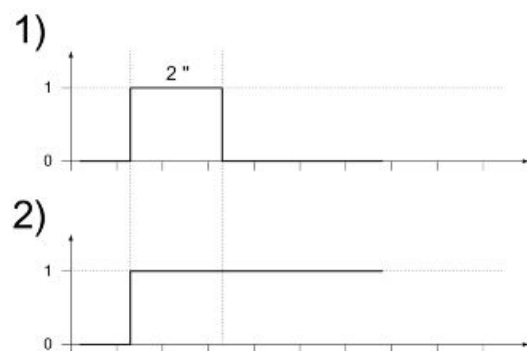

ted but with a limitation imposed on the number of revs.

**2. Previously unused control unit - transponder absent or cannot be used:** The LED is permanently ON; in this condition, no operations are possible, including starting of the vehicle.

**3. Programmed control unit - the service key in (normal condition of use):** a single 0.7 second flash is displayed, after which the LED remains off permanently. The engine can be started.

**4. Programmed control unit - Master key in:** a 0.7 sec. flash is displayed followed by the LED remaining off for 2 sec. and then by short 0.46 sec. flashes the same number of times as there are keys stored in the memory including the Master key. When the diagnosis has been completed, the LED remains permanently OFF. The engine can be started.

**5. Programmed control unit - fault detected:** a light code is displayed according to the fault detected, after which the LED remains on permanently. The engine cannot be started. The codes that can be transmitted are:

- Code 1 flash
- 2 flash code
- 3 flash code

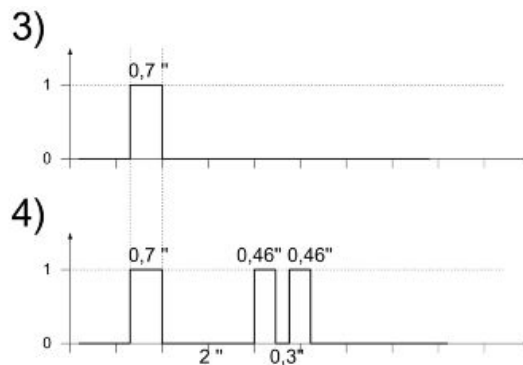

## Diagnostic code - 1 flash

The one-flash code indicates a system where the serial line is not present or is not detected. Check the Immobiliser aerial wiring and change it if necessary.

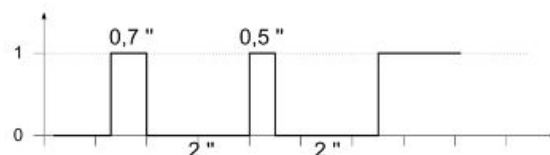

## Diagnostic code - 2 flashes

Two-flash code shows a system where the control unit does not show the transponder signal. This might depend on the inefficiency of the immobiliser aerial or the transponder.

Turn the switch to ON using several keys: if the code is repeated even with the Master key, check the aerial wiring and change it if necessary. If this is not the case, replace the defective key and/or reprogram the control unit. Replace the control unit if the problem continues.

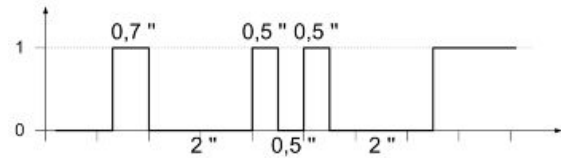

## Diagnostic code - 3 flashes

The three-flash code indicates a system where the control unit does not recognise the key. Turn the switch to ON using several keys: if the error code is repeated even with the Master key, replace the control unit. If this is not the case, perform a re-programming.

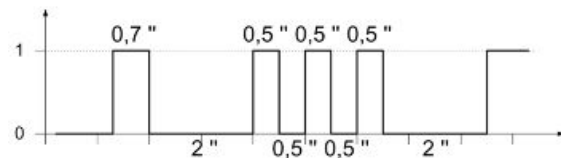

## Battery recharge circuit

The recharge system is provided with a three phase alternator with permanent flywheel.

The alternator is directly connected to the voltage regulator.

This, in its turn, is connected directly to the ground and the battery positive terminal passing through the 30A protective fuse.

The three- phase generator provides good recharge power and at low revs a good compromise is achieved between generated power and idle stability.

## Stator check

### Stator winding check-up

#### WARNING

**THE CHECK-UP CAN BE MADE WITH THE STATOR PROPERLY INSTALLED.**

- 1 Remove the right side panel.
- 2) Disconnect the connector between stator and regulator with the three yellow cables as shown in the photograph.
- 3) Measure the resistance between each of the yellow terminals and the other two.

**Electric characteristic****Resistance:**0.2 - 1  $\Omega$ 

- 4) Check that there is insulation between the each yellow cable and the earth.
- 5) If values that are wrong are noted, replace the stator.

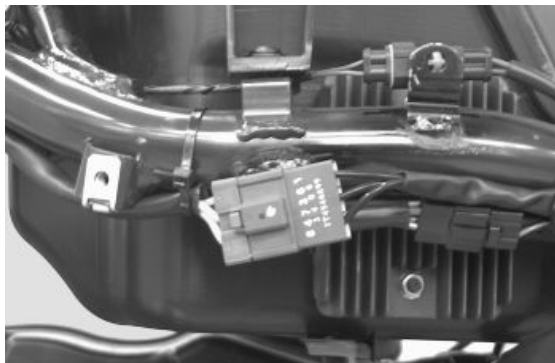
**Recharge system voltage check****Look for any leakage**

- 1) Access the battery by removing its cover under the saddle.
- 2) Check that the battery does not show signs of losing fluid before checking the output voltage.
- 3) Turn the ignition key to position OFF, connect the terminals of the tester between the negative pole (-) of the battery and the black cable and only then disconnect the black cable from the negative pole (-) of the battery.
- 4) With ignition key still at OFF, the reading detected by the ammeter must be  $\leq 0.5$  mA.

**Check the charging current****WARNING**

**BEFORE CARRYING OUT THE CHECK, MAKE SURE THAT THE BATTERY IS IN GOOD WORKING ORDER.**

- 1) Place the vehicle on its centre stand
- 2) With the battery correctly connected to the circuit, place the tester terminals between the battery terminals..
- 3) Turn on the engine, increase the revs and, at the same time, measure the voltage.

**Electric characteristic**

**Voltage ranging between 14.0 and 15.0V at 5000 rpm.**

**Maximum current output check.**

- With the engine off and the panel at «ON» with the lights on, allow the battery voltage to stop at 12V.
- Connect ammeter pliers to the 2 recharge positive poles in output from the regulator.
- Start the engine and rev it up to a high engine speed while reading the value on the pincer.

With an efficient battery a value must be detected: > 20A

**VOLTAGE REGULATOR/RECTIFIER**

Specification	Desc./Quantity
Type	Non-adjustable three-phase transistor

Specification	Desc./Quantity
Voltage	14 ÷ 15V at 5000 rpm with lights off

## Fuses

The electrical system has twelve fuses divided into two fuse boxes to protect the different installation circuits. One of them is inside the battery compartment «A» and the other is at the internal side of the right footrest «B». To have access, loosen the screw «C» and remove the plastic cover. The chart shows the position and characteristics of the fuses in the vehicle.

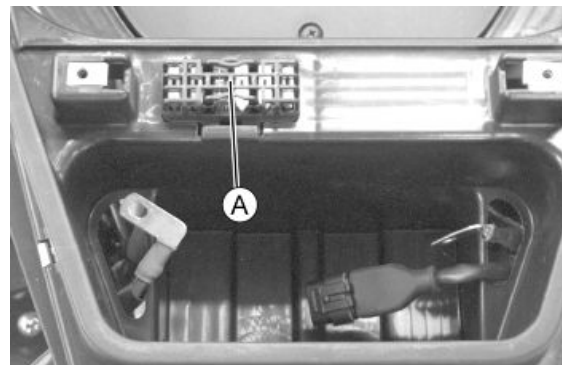

**CAUTION**



**BEFORE REPLACING THE BLOWN FUSE, FIND AND SOLVE THE FAILURE THAT CAUSED IT TO BLOW. NEVER TRY TO REPLACE THE FUSE WITH ANY OTHER MATERIAL (E.G., A PIECE OF ELECTRIC WIRE).**

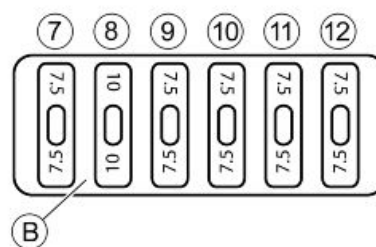
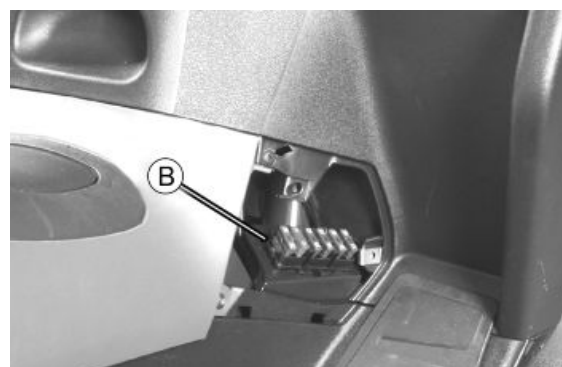
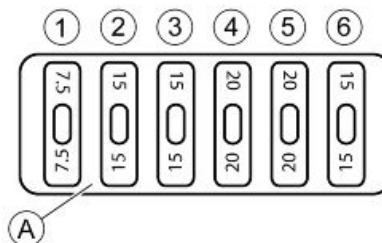

**FUSE TABLE**

	<b>Specification</b>	<b>Desc./Quantity</b>
1	Fuse No. 1	<b>Capacity: 7.5 A</b> <b>Protected circuits:</b> Injection ECU battery power
2	Fuse No. 2	<b>Capacity: 15 A</b> <b>Protected circuits:</b> Battery-powered injection loads, electrical fan
3	Fuse No. 3	<b>Capacity: 15 A</b> <b>Protected circuits:</b> Battery-powered saddle opening switch, glove-box lighting, light switch, turn indicator switch, antitheft installation, fuse No. 12
4	Fuse No. 4	<b>Capacity: 20A</b> <b>Protected circuits:</b> battery-powered ECU for parking control
5	Fuse No. 5	<b>Capacity: 20A</b> <b>Protected circuits:</b> battery-powered fuse No. 7, live fuses No. 8 - No. 9 - No.10 - No. 11
6	Fuse No. 6	<b>Capacity: 15 A</b> <b>Protected circuits:</b> L.V. socket.
7	Fuse No. 7	<b>Capacity: 7.5 A</b> <b>Protected circuits:</b> Battery-powered instrument panel
8	Fuse No. 8	<b>Capacity: 10A</b> <b>Protected circuits:</b> Live stop, start-up and start-up enabling switch and start-up circuit.
9	Fuse No. 9	<b>Capacity: 7.5 A</b> <b>Protected circuits:</b> live passing and horn
10	Fuse No. 10	<b>Capacity: 7.5A</b> <b>Protected circuits:</b> Live injection ECU, immobilizer aerial, electric fan remote control, injection loads remote control
11	Fuse No. 11	<b>Capacity: 7.5A</b> <b>Protected circuits:</b> Live ECU parking lever, antitheft installation, instrument panel, headlight remote control, horn
12	Fuse No. 12	<b>Capacity: 7.5A</b> <b>Protected circuits:</b> Live turn indicator control, saddle opening switch, tail lights, panel lighting

Dashboard

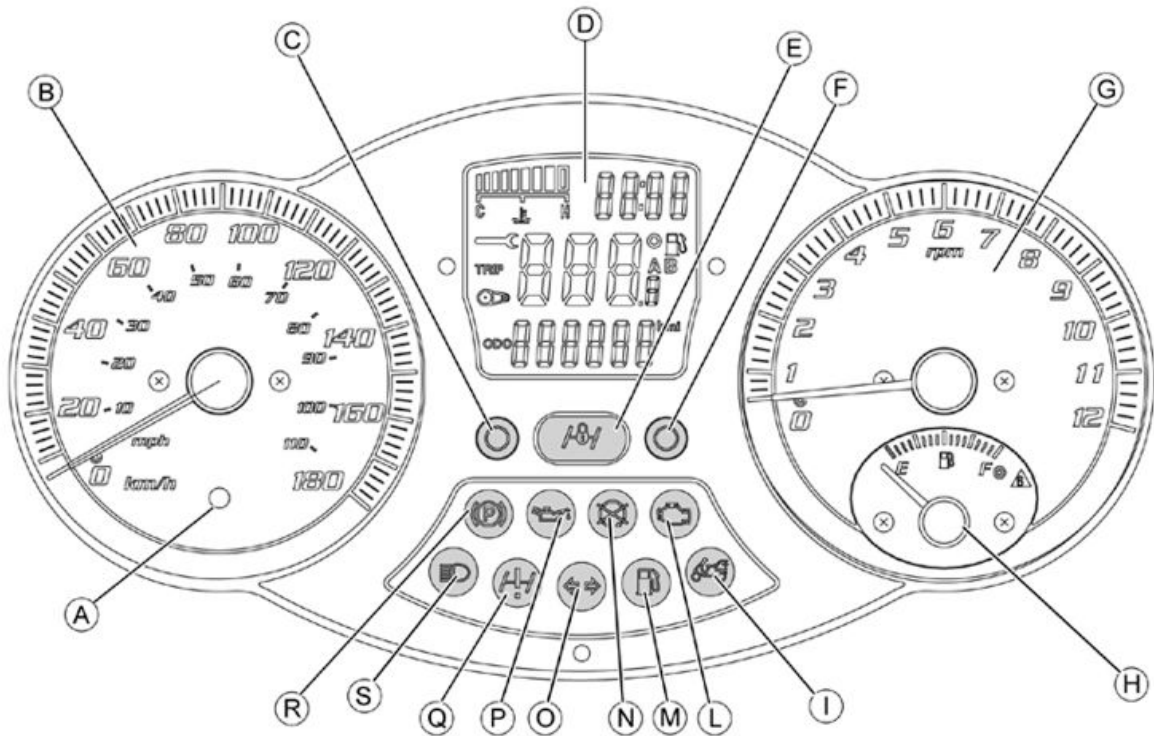

- A = Led immobilizer / anti-theft device
- B= Speedometer with twin scale (km/h and mph)
- C = CLOCK switch
- D = Digital display
- E = Front suspension locking system warning light (if available)
- F = SET switch
- G = Rpm indicator
- H = Fuel gauge
- I = Warning light for helmet compartment courtesy light on
- L = Engine control telltale light and injection system failure warning light
- M = Low fuel warning light
- N = Engine stop warning light
- D= Turn indicator warning light
- P = Low oil pressure warning light
- Q = Front suspension locking system failure warning light (if available)
- R = Warning light for parking brake engaged

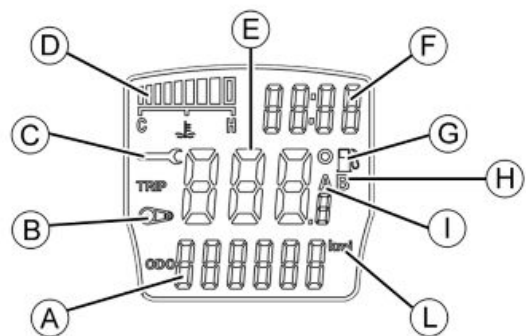

- 
- C = High-beam warning light
  - A = Total odometer gauge
  - B = «BELT» maintenance icon
  - C = «SERVICE» maintenance icon
  - D = Engine coolant temperature indicator
  - E = Trip odometer gauge (A-B) and ambient temperature (selected with the MODE button)
  - F = TIME-DATE indicator
  - G = Low fuel warning light
  - H = Trip odometer gauge (B)
  - I = Trip odometer gauge (A)
  - L = Kilometre - mile indicator
- 

## Sealed battery

If the vehicle is provided with a sealed battery, the only maintenance required is the check of its charge and recharging, if necessary.

These operations should be carried out before delivering the vehicle, and on a six-month basis while the vehicle is stored in open circuit.

Besides upon pre-delivery it is therefore necessary to check the battery charge and recharge it, if required, before storing the vehicle and afterwards every six months.

### INSTRUCTIONS FOR THE RENEWAL RECHARGE AFTER OPEN-CIRCUIT STORAGE

#### 1) Voltage check up

Before installing the battery on the vehicle, check the open circuit voltage with a normal tester.

- If voltage exceeds 12.60 V, the battery can be installed without any renewal recharge.
- If voltage is below 12.60 V, a renewal recharge is required as explained in 2).

#### 2) Constant voltage battery charge mode

- Constant voltage charge equal to 14.40 ÷ 14.70V
- Initial charge voltage equal to 0.3 ÷ 0.5 for nominal Capacity
- Charge time:
  - 10 to 12 h recommended
  - Minimum 6 h
  - Maximum 24 h

#### 3) Constant current battery charge mode

- Charge current equal to 1/10 of the battery rated capacity
  - Charge time: Maximum 5 h
-



## Connectors

### INJECTION ELECTRONIC CONTROL UNIT

1. Injection telltale light (Brown-Black)
2. Rpm indicator on instrument panel (Yellow)
3. CAN "L" Line (White-Blue)
4. Lambda probe (-) (White-Green)
5. Live supply (Red-White)
6. Battery powered (Orange-Black)
7. Immobilizer aerial (Orange-White)
8. Electric fan remote control (Blue-Yellow)
9. Coolant temperature sensor (Sky blue-Green)
10. CAN "H" Line (Pink-White)
11. Lambda probe (+) (Sky blue-Black)
12. Engine stop switch (Green-Black)
13. Engine revolution sensor positive (Red)
14. Fuel injector (Red-Yellow)
15. Engine revolution sensor negative (Brown)
16. Diagnosis (Purple-White)
17. Immobilizer LED (Red-Green)
18. Engine stop switch, coolant temperature sensor (Grey-Green)
19. Not connected
20. Injection load remote control (Black-Purple)
21. Not connected
22. HV coil (Pink-Black)
23. Not connected
24. Start-up enabling switch (Orange-Blue)
25. Not connected
26. Ground (Black)

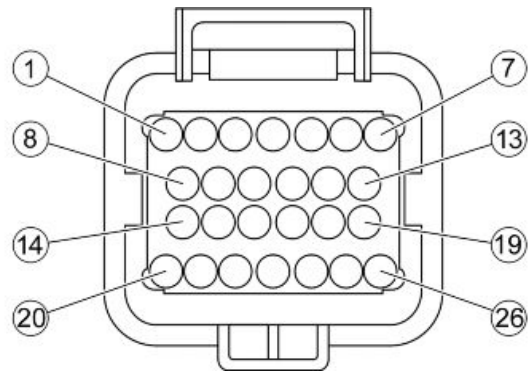

### PICK-UP CONNECTOR

1. Injection electronic control unit (Red)
2. Injection electronic control unit (Brown)

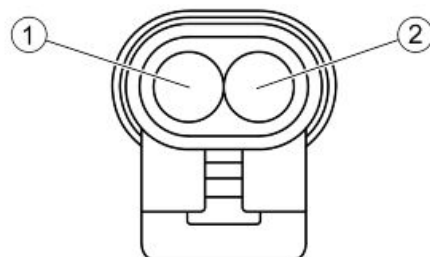

**VOLTAGE REGULATOR CONNECTOR**

1. +Battery (Red-Black)
2. Ground (Black)
3. +Battery (Red-Black)
4. Ground (Black)

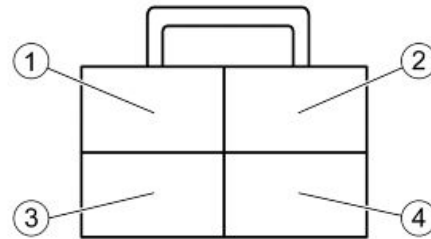
**SADDLE OPENING RECEIVER CONNECTOR**

1. Aerial (Purple)
2. Saddle opening actuator (Yellow-Grey)
3. Reset (Blue-Black)
4. Battery powered (Blue)
5. Not connected
6. Live supply (Yellow-Black)
7. Ground
8. Not connected
9. Not connected
10. Not connected
11. Channels 1/3 selector (Green-Blue)
12. Alarm code (Orange-Black)

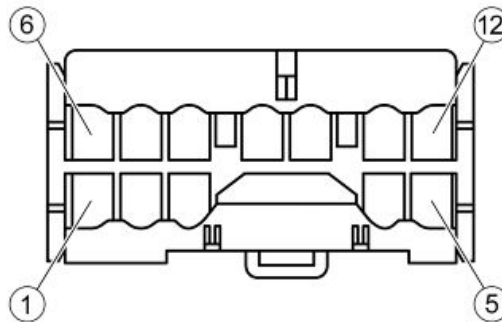
**TURN INDICATOR CONTROL DEVICE CONNECTOR**

1. Hazard switch (Brown)
2. LHS Switch (White-Pink)
3. RHS Switch (Blue-Black)
4. LHS Turn indicators (Pink)
5. RHS Turn indicators (White-Blue)
6. Battery powered (Blue)
7. Not connected
8. Live supply (Yellow-Black)
9. Ground (Black)
10. Not connected
11. Not connected
12. Not connected

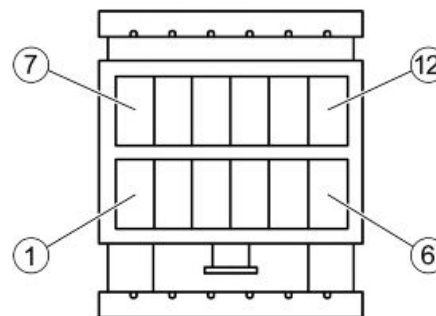

**HV COIL CONNECTOR**

1. Injection load remote control (Black-Green)
2. Injection electronic control unit (Pink-Black)

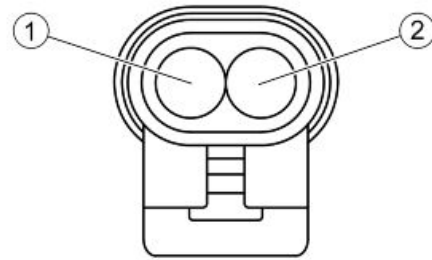
**ANTI-THEFT DEVICE PRE-INSTALLATION CONNECTOR**

1. LHS Turn indicators (Pink)
2. RHS Turn indicators (White-Blue)
3. Ground (Black)
4. Battery powered (Blue)
5. Live supply (Yellow-Red)
6. Helmet compartment lighting (Blue-Black)
7. Channels 1/3 selector (Green-Blue)
8. Alarm code (Orange-Black)

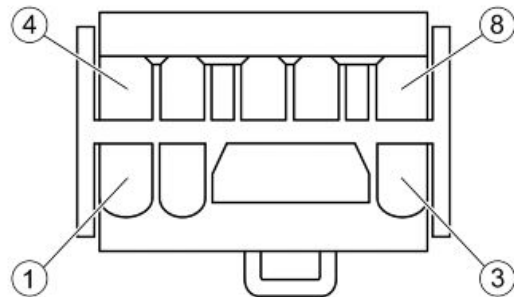
**FUEL PUMP CONNECTOR**

1. Injection load remote control (Black-Green)
2. Not connected
3. Not connected
4. Ground (Black)
5. Not connected

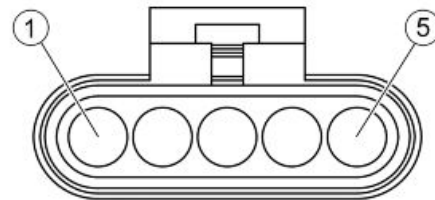
**INSTRUMENT PANEL CONNECTOR "A"**

1. Not connected
2. Not connected
3. Not connected
4. Not connected
5. Instrument panel lighting (Yellow-Black)
6. Battery powered (Red-Blue)
7. Not connected
8. Not connected
9. Not connected
10. Not connected

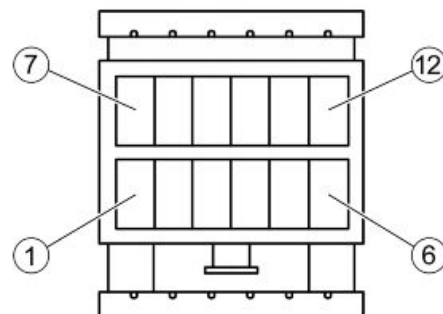

- 11. Ground (Black)
- 12. Live supply (Yellow-Red)

#### INSTRUMENT PANEL CONNECTOR "B"

- 1. Scooter speed signal (Sky blue)
- 2. Fuel level signal (White-Green)
- 3. Water temperature sensor (Sky blue-Black)
- 4. Water temperature sensor ground lead (Brown-White)
- 5. «MODE» remote button (Green)
- 6. Oil pressure warning light (Pink-White)
- 7. LHS Turn indicator warning light (Pink)
- 8. RHS Turn indicator warning light (White-Blue)
- 9. High-beam warning light (Purple)
- 10. Boot open warning light (Blue-Black)
- 11. Rpm sensor (Yellow)
- 12. Ambient temperature sensor (Yellow-Blue)
- 13. Ambient temperature sensor ground lead (White-Yellow)
- 14. Engine disabled warning light (Orange-Blue)
- 15. Immobilizer warning light (Red-Green)
- 16. Engine check warning light (Brown-Black)
- 17. Parking brake warning light (Yellow-Grey)
- 18. Tilt locking activated warning light (Pink-Black)
- 19. Tilt locking system failure warning light (Grey-Black)
- 20. Live supply from the parking control ECU (Yellow-Green)

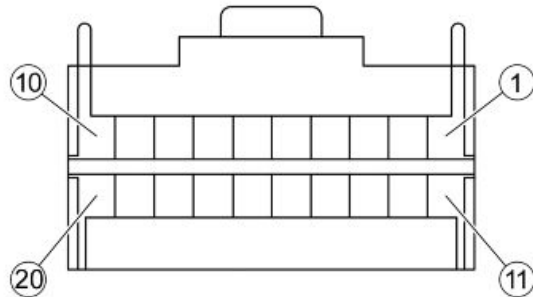

#### PARKING CONTROL ECU CONNECTOR

- 1A. Potentiometer supply (Orange-Blue)
- 2A. CAN "L" Line (White-Blue)
- 3A. Warning light supply (Yellow-Green)
- 4A. Tilt locking activated warning light (Pink-Black)
- 5A. Tilt locking system failure warning light (Grey-Black)
- 6A. Headlight remote control (White-Black)
- 7A. Potentiometer ground lead, rpm sensor, rider presence sensor (Yellow)

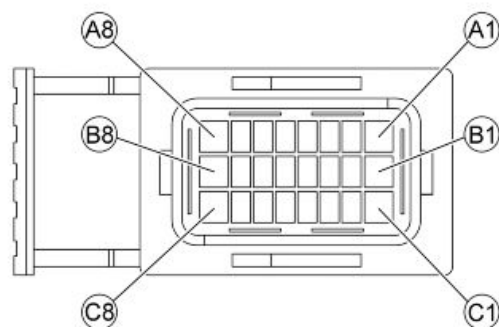

- 8. Ground (Black)
- 1B. Live supply (Yellow-Red)
- 2B. CAN "H" Line (Pink-White)
- 3B. Left wheel turning sensor (Green)
- 4B. Right wheel turning sensor (Red)
- 5B. Potentiometer signal (Green-Blue)
- 6B. Locking/unlocking switch (Green-Grey)
- 7B. Horn remote control for alarms (White)
- 8B. Geared motor (White-Red)
- 1C. Battery powered (Blue-Red)
- 2C. Diagnosis (Purple-White)
- 3C. Locking/unlocking switch (Yellow-Blue)
- 4C. Calliper sensor (Brown)
- 5C. Locking/unlocking switch (Purple-Black)
- 6C. Rider presence sensor (Purple)
- 7C. Scooter speed signal (Sky blue)
- 8C. Geared motor (Blue)

---

## Remote seat opening

---

### Zeroing

- Remove the left side fairing to access the saddle opening receiver control unit indicated in the photograph
- Remove the metal terminal and connect it to a good earth point, or to terminal 7 (black), for at least 10 seconds.
- In this operation all the remote controls stored in the control unit will be deleted.

**WARNING**

**THE CONTROL UNIT CAN PROGRAMME UP TO 8 REMOTE CONTROLS.**

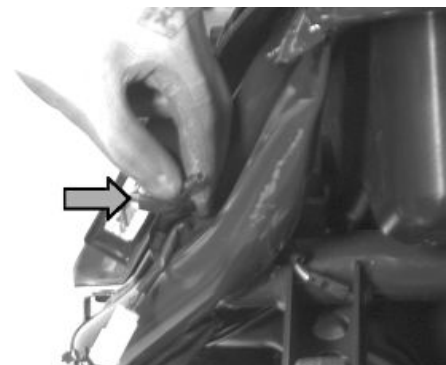
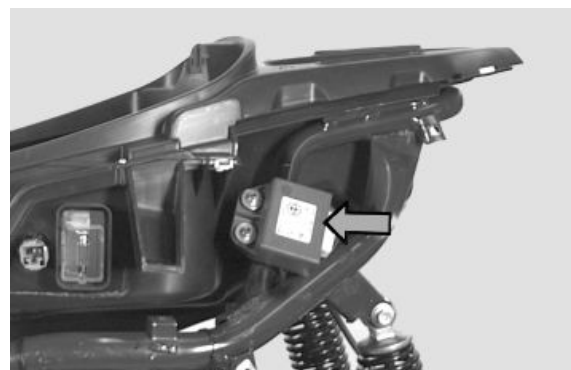

---

## Programming

Follow these steps to program the remote controls:

1. Insert the remote control key to be programmed in the steering lock key block.
2. Turn the key to the «ON» position, press the button on the remote control, release the button, turn the key back to the «OFF» position from the «ON» position, all within four seconds.
3. Wait from 1 to 8 seconds.
4. Repeat steps 2 and 3 for 4 times without removing the key.

The control unit confirms the programming has been successfully executed by opening the saddle.

**WARNING**

**TO STORE THE OTHER REMOTE CONTROLS TO MEMORY (8 MAXIMUM) YOU NEED TO REPEAT THE WHOLE PROCEDURE AGAIN. FAILURE TO CARRY OUT THESE OPERATIONS WITHIN THE INDICATED TIMES WILL RESULT IN THE AUTOMATIC CANCELLATION OF THE PROCESS FOR PROGRAMMING THE REMOTE-CONTROLLED KEYS.**

**WARNING**

**AVOID PRESSING THE REMOTE CONTROL BUTTON MORE THAN ONCE WHEN FAR AWAY FROM THE SCOOTER. THE SYNCHRONISM BETWEEN THE REMOTE CONTROL AND THE RECEIVER CAN BE IMPAIRED. SHOULD THIS BE THE CASE, REPEAT THE PROGRAMMING PROCEDURE. DO NOT KEEP THE REMOTE CONTROL IN PLACES WITH TEMPERATURES EXCEEDING 60° C THE BATTERY WILL RUN DOWN TOO QUICKLY.**

**WARNING**

**TO AVOID BATTERY DISCHARGE, THE SADDLE OPENING REMOTE CONTROL RADIO RECEIVER DEACTIVATES 7 DAYS AFTER THE LAST TIME THE VEHICLE WAS SHUT OFF. JUST TURN THE KEY TO «ON» TO REACTIVATE THE RECEIVER.**

---

## INDEX OF TOPICS

ENGINE FROM VEHICLE

ENG VE

---

This section describes the operations to carry out when removing the engine from the vehicle.

---

## Exhaust assy. Removal

- Remove the side fairings.
- Remove the central frame cover.
- Remove the exhaust end.
- Disconnect the lambda probe connector.



- Unscrew the probe.

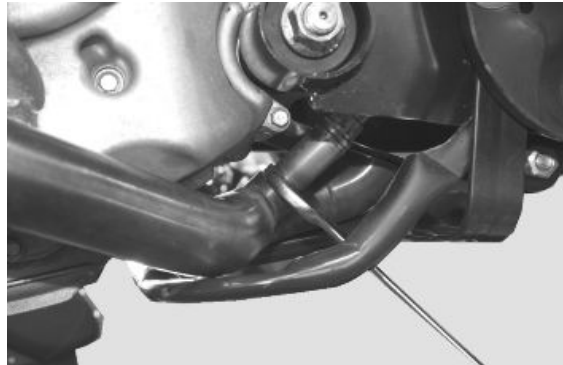

- Working from both sides, release the two clamps securing the exhaust manifold to the head.
- Detach the exhaust manifold making it pass through the swinging arm.

### CAUTION

**SHOULD IT BE NECESSARY TO REMOVE ONLY THE MUFFLER TIP, ALWAYS REPLACE THE GRAPHITE GASKET BETWEEN STUB AND TIP.**



To fit, follow the removal steps but in reverse order; be careful to tighten to the correct locking torques once the muffler silencer has been refitted.

---

## Removal of the engine from the vehicle

- Use a jack to support the vehicle properly.
- Disconnect the battery.
- Remove the engine cover inside the helmet compartment.
- Remove the side fairings.
- Remove the footrests.

Remove the full muffler unit.



**CAUTION****THIS OPERATION MUST BE CARRIED OUT WHEN THE ENGINE IS COLD.**

- Remove the rear wheel.

- Remove the bracket supporting the rear brake callipers and the callipers as well.

- After removing the air filter from the crankcase, undo the screws fixing the bracket that secures the rear brake pipes.

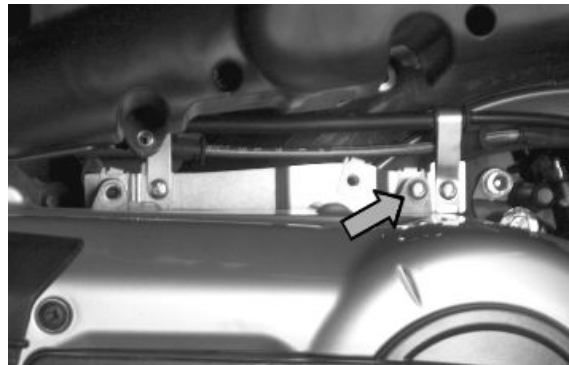

- Remove the pipe feeding coolant into the pump as shown in the photograph and then empty the system.

- Remove the engine coolant outlet pipe as indicated.



- Disconnect the fuel delivery pipe from the injector by removing the screw locking the retainer clamp.

- Disconnect the injector wiring and the throttle body control unit wiring.



- Remove the coolant outlet pipe from the motor as indicated.



- Remove the spark plug caps.
- Remove the coolant temperature sensor connector indicated in the photo.



- Remove the throttle cables from the throttle body by undoing the nuts indicated in the photograph.
- Remove the negative terminal cable from the starter motor.

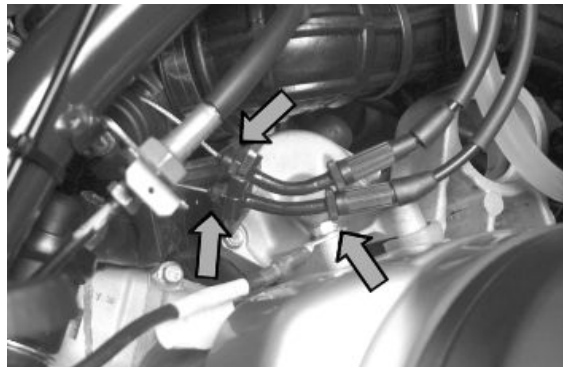

- Remove the positive terminal cable from the starter motor as shown in the photograph.
- Remove the engine ground lead.

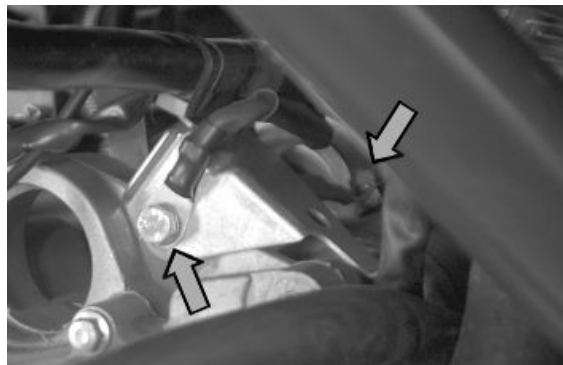

- Disconnect the connectors from the flywheel wiring as shown in the photo.
- Remove the cable from the retaining clip on the flywheel cover.

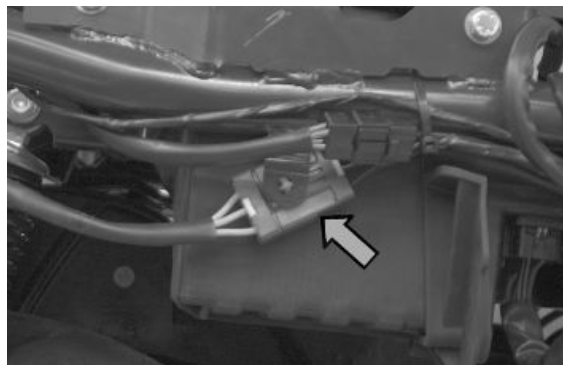

Remove the lower screw of the left-hand shock absorber.



- Remove the engine-swinging arm fixing pin by undoing the nut and operating on the head of the pin as shown in the photograph.

- The engine is now free.

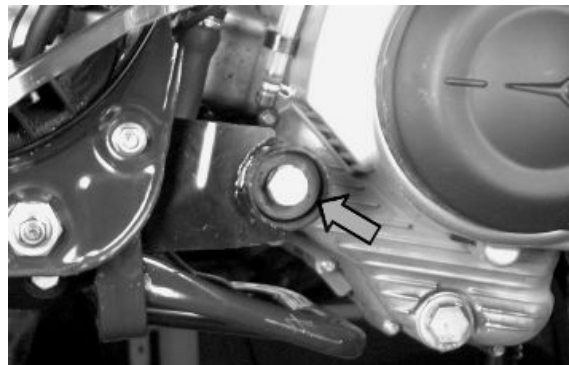
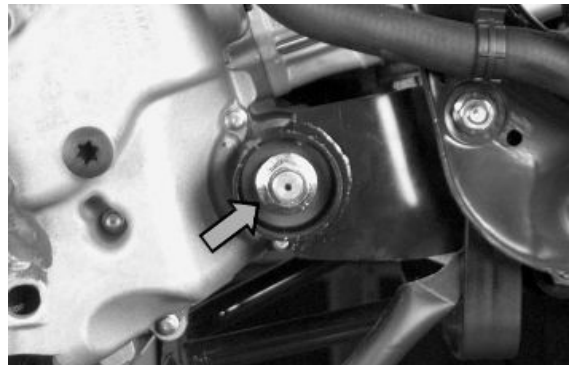

When refitting the engine to the scooter, carry out the operations in reverse order from that adopted when removing it and respect the tightening torque shown in the Characteristics Chapter.

- Check the engine oil level and if necessary top it up with the recommended type.

- Fill and bleed the cooling circuit.

- Check the functioning of the accelerator and the electrical devices.

**CAUTION**

**PAY PARTICULAR ATTENTION TO POSITIONING THE THROTTLE COMMAND TRANSMISSION PROPERLY.**



# INDEX OF TOPICS

ENGINE

ENG

---

This section describes the operations to be carried out on the engine and the tools to be used.

---

## Automatic transmission

---

### Transmission cover

---

- Loosen the 4 fastening screws
- Extract the outside plastic transmission cover.



- Using a screwdriver, remove the driven pulley axle cover near the bottom of the cap.



- Loosen the driven pulley shaft fastening nut using a misaligned wrench and prevent the pulley shaft rotation using a machine hexagon bush.
- Remove the nut and the two washers.

**N.B.**

**DUE TO THE HIGH TIGHTENING TORQUE, USING DIFFERENT WRENCHES - SUCH AS A CONVENTIONAL POLYGONAL BUSH - MAY DAMAGE THE HEXAGON OBTAINED ON THE SHAFT OR BREAK THE BUSH ITSELF.**



- 
- Remove the six M6 screws.



- 
- Remove the four M8 screws.
  - Remove the transmission cover.
  - Check that the bearing rotates freely, otherwise replace it.



---

## **Air duct**

- Remove the transmission cover.
- Unscrew the two screws shown in the figure to remove the air conveyor.

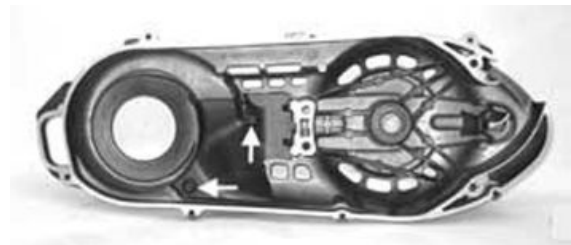

### **Locking torques (N\*m)**

**Air conveyor screws 11 ÷ 12**

- 
- Remove the external transmission cover.
  - Unscrew the 4 fastening screws shown in the figure to remove the external air conveyor.

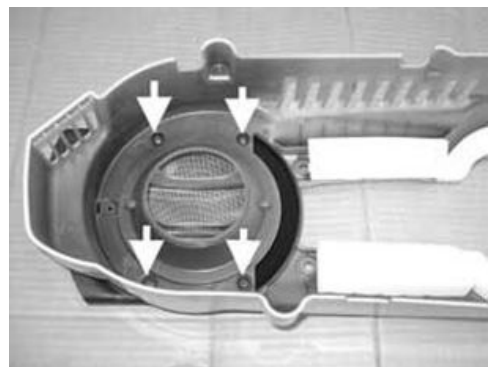

## Air duct filter

- Remove the external air conveyor.
- Unscrew the 2 fastening screws shown in the figure to remove the conveyor filter.



## Removing the driven pulley shaft bearing

- Remove the transmission cover.
- Remove the seeger ring.



- Place transmission cover on a wood surface and use the special tool so that it is adequately supported.
- Pull out the bearing using the special tool.

**N.B.**

**BELL MUST BE PLACED INTO THE TRANSMISSION COVER, CLOSE TO THE BEARING SEAT AND THE WOODEN SURFACE, SINCE WITHOUT BELL THE ENTIRE COVER STRUCTURE WOULD BEND. NOT ONLY IN THE AREA OF MAXIMUM STURDINESS.**

### Specific tooling

001467Y002 Driver for OD 73 mm bearing

020376Y Adaptor handle

020375Y 28 x 30 mm adaptor

020439Y 17 mm guide





## Refitting the driven pulley shaft bearing

- Heat the transmission cover interior using the heat gun.

**N.B.**

**BE CAREFUL NOT TO OVERHEAT THE COVER AS THIS WOULD DAMAGE THE OUTSIDE PAINTED SURFACE.**

### Specific tooling

020151Y Air heater



- Place the bearing onto the special tool with a little grease to prevent it from coming out.
- Install the new bearing using the special tool.

**N.B.**

**PROPERLY SUPPORT THE OUTSIDE COVER TO PREVENT DAMAGING THE PAINTED SURFACE.**

### Specific tooling

020376Y Adaptor handle

020358Y 37x40 mm adaptor

020439Y 17 mm guide



## Baffle roller

### Plastic roller

- Check that the roller does not show signs of wear and that it turns freely.
- Loosen the retaining bolt using a 13 mm spanner.
- Remove the complete roller with bearing.

**N.B.**

**IF THE ROLLER DOES NOT ROTATE FREELY, REPLACE THE COMPLETE ROLLER.**



### Installation of belt anti-vibration roller

- Install the anti-flapping roller with the lip facing the engine crankcase.
- Tighten the central screw to the prescribed torque.

**N.B.**

**TURN THE DRIVEN AND/OR DRIVING PULLEY UNTIL A CORRECT TENSIONING OF THE BELT IS OBTAINED.**

### Locking torques (N\*m)

---

**Anti-vibration roller screw 16.7 - 19.6**

---

**Removing the driven pulley**

---

- Remove the clutch bell.

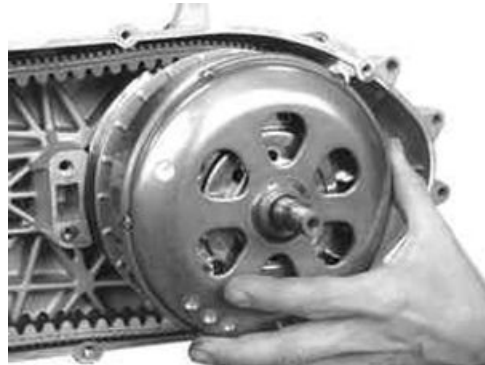

- Remove the fixed driving half-pulley.
- Remove the driven pulley assembly with the belt.

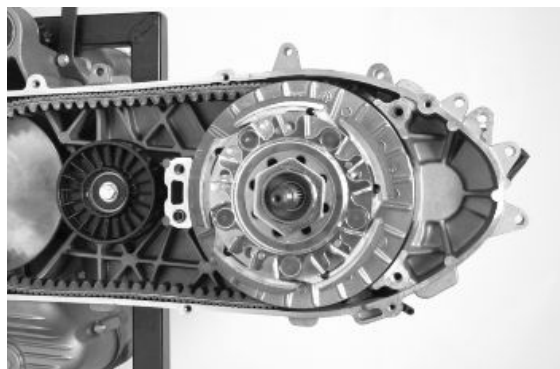

---

**Inspecting the clutch drum**

---

- Check that the clutch bell is not worn or damaged.
- Measure the clutch bell inside diameter.

**N.B.**

**CHECK THE ECCENTRICITY MEASURED, 0.2 MM MAX.**

**Characteristic****Max. value:**

160.5 mm

**Standard value:**

160.2 mm

---



## Removing the clutch

- To remove the clutch with the driven pulley it is necessary to use the special tool;
- Arrange the tool with the mean pins screwed in position "E" on the inside;
- Fit the adapter ring to the clutch assembly as shown in the photograph.
- Install the driven pulley unit onto the tool inserting the pins into the ventilation holes;
- Move the rear stop screw in abutment against the fixed driven pulley as shown in the figure.

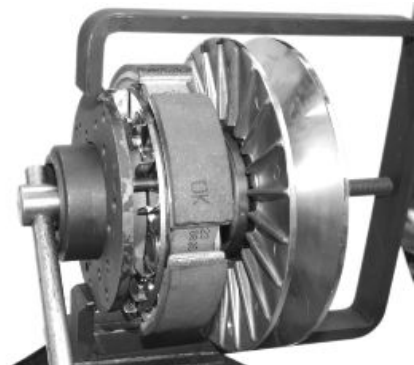
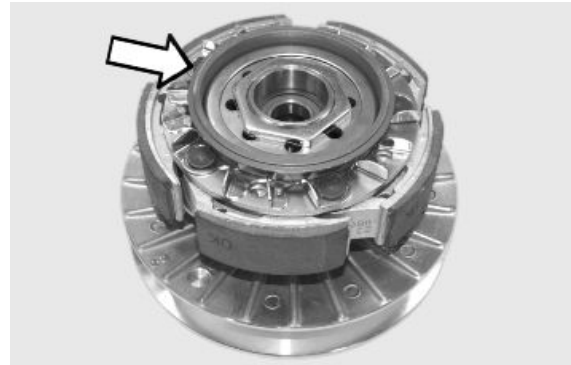

### CAUTION

**THE TOOL SHOULD BE FIRMLY SECURED IN A VICE USING THE SPECIAL TOOL. DO NOT TIGHTEN THE REAR SCREW TOO MUCH AS THIS COULD CAUSE AN IRREVERSIBLE TOOL DEFORMATION.**

**USING THE SPECIAL 55-MM WRENCH, REMOVE THE FASTENING RING NUT.**

**LOOSEN THE TOOL SCREW AND DISASSEMBLE THE DRIVEN PULLEY UNIT, CLUTCH, SPRING WITH SHEATH.**

### Specific tooling

**020444Y Tool for fitting/ removing the driven pulley clutch**

## Inspecting the clutch

- Check the thickness of the clutch mass friction material.

### Characteristic

#### Minimum thickness permitted:

1 mm

- The masses must not show traces of lubricants. Otherwise, check the driven pulley unit seals.

### N.B.

**UPON RUNNING-IN, THE MASSES MUST EXHIBIT A CENTRAL CONTACT SURFACE AND MUST NOT BE DIFFERENT FROM ONE ANOTHER. VARIOUS CONDITIONS CAN CAUSE THE CLUTCH TO TEAR.**

- 
- Do not open the masses using tools to prevent a variation in the return spring load.

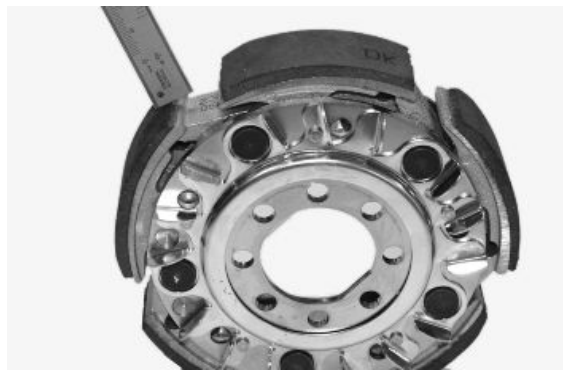

---

### Pin retaining collar

- 
- Extract the collar using 2 screwdrivers.



- 
- Remove the 4 guide pins.
  - Extract the moving driven half-pulley.



---

### Removing the driven half-pulley bearing

- 
- Check that the bushing is free from wear and damage; otherwise replace the fixed driven half-pulley.
  - Remove the lock ring using pliers.



- Using the special tool inserted through the roller bearing, pull out the ball bearing.

**N.B.**

**PROPERLY SUPPORT THE PULLEY TO PREVENT DAMAGING THE THREADING.**

#### Specific tooling

020376Y Adaptor handle

020456Y Ø 24 mm adaptor

020363Y 20 mm guide

**N.B.**

**IF YOU NEED TO OVERHAUL THE BEARINGS ON AN ASSEMBLED DRIVEN PULLEY UNIT, IT IS NECESSARY TO SUPPORT THE UNIT BY THE BELL**

#### Specific tooling

001467Y002 Driver for OD 73 mm bearing

- Remove the roller bearing using the special tool, supporting the fixed half-pulley with the bell.

#### Specific tooling

020376Y Adaptor handle

020375Y 28 x 30 mm adaptor

020364Y 25 mm guide

001467Y002 Driver for OD 73 mm bearing



## Inspecting the driven fixed half-pulley

- Check that the belt contact surface is free from wear.
- Measure the outer diameter of the pulley bushing.

#### Characteristic

##### Minimum admissible diameter

49.96 mm

##### Standard diameter:

49.965 mm



## Inspecting the driven sliding half-pulley

- Check that the belt contact surface is free from wear.
- Remove the 2 inside sealing rings and the 2 outside O-rings.
- Measure the movable half-pulley bushing inside diameter.



### Characteristic

#### Maximum admissible diameter:

50.08 mm

#### Standard diameter:

50.085 mm

## Refitting the driven half-pulley bearing

- Install a new roller bearing using the special tool.

**N.B.**

**PLACE THE BEARING WITH THE WRITINGS AND THE EMBEDDED OIL GUARD FACING OUTWARDS.**

- Properly support the half-pulley to prevent damaging the threading.

If you are working on the driven pulley unit fully assembled, use the special tool.

### Specific tooling

**020478Y Punch for driven pulley roller casing**

**001467Y002 Driver for OD 73 mm bearing**



- Install a new ball bearing using the special tool.

### Specific tooling

**020376Y Adaptor handle**

**020477Y 37 mm adaptor**

**020363Y 20 mm guide**



- Insert the seeger lock ring.

---

## Refitting the driven pulley

- Insert the new oil guards
- Insert the new O-rings

**N.B.**

**O-RINGS ARE OF TWO SIZES. THE LARGE ONE IS INSTALLED ON THE MACHINING END RADIUS, AT THE BASE OF THE HALF-PULLEY.**

- Install the half-pulley on the bushing being careful not to damage the top sealing ring during the introduction.
- Make sure the pins and collar are not worn, re-assemble the pins and collar.



- Using a bent beak greaser, lubricate the driven pulley unit with about 10 gr. of grease, this operation should be carried out through one of the two holes into the bushing to obtain the exit of the grease from the opposite hole. This operation is necessary to avoid the presence of grease beyond the O-rings.

### Recommended products

**AGIP GREASE SM 2 Grease for the tone wheel revolving ring**

Soap-based lithium grease containing NLGI 2 Molybdenum disulphide; ISO-L-XBCHB2, DIN KF2K-20

---

## Inspecting the clutch spring

- Measure the length of the spring, while it is relaxed.

**Characteristic****Standard length:**

125.5 mm

**Admissible limit after use:**

120 mm



---

## Refitting the clutch

- Prepare the special tool as for removal;
- Preassemble the driven pulley unit with the drive belt according to its direction of rotation;
- Insert the driven pulley unit, the spring with sheath and clutch into the tool.



### Specific tooling

#### 020444Y Tool for fitting/ removing the driven pulley clutch

- Compress the spring and insert the clutch on the driven pulley bushing.

N.B.

**BE CAREFUL NOT TO DAMAGE THE SHEATH OR THE BUSHING THREADED END.**

- Tighten the ring nut by hand and complete the tightening using the special wrench to the prescribed torque.



### Specific tooling

#### 020444Y Tool for fitting/ removing the driven pulley clutch

#### Locking torques (N\*m)

#### Clutch ring nut 65 - 75

- To facilitate reassembly on the engine, turn the moving driven pulley and insert the belt onto the smaller diameter.

---

## Refitting the driven pulley

- Install the driven pulley assembly with belt.

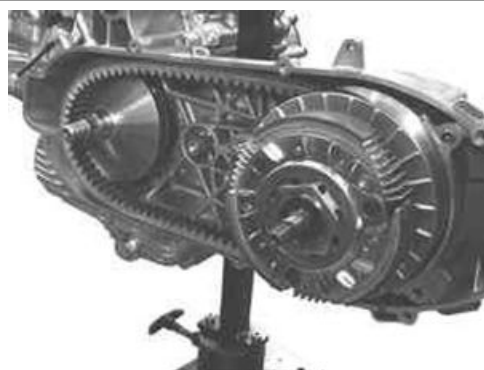



## Drive-belt

- Check that the driving belt is not damaged.
- Check the width of the belt.

### Characteristic

#### Minimum width

27.5 mm

#### Overall width

28.7 mm

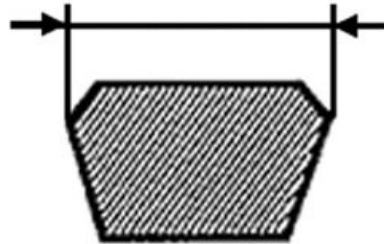

## Removing the driving pulley

- Using a 27 mm wrench, turn the central pulley nut to horizontally align the central inside holes and install the special tool.

### Specific tooling

**020474Y Driving pulley lock wrench**



- First fit the 2 retainer clamps of the special tool onto the pulley so that the splines are completely engaged.
- Then, insert the tool so as to insert the stud bolts on the ring into the holes obtained onto the tool itself.
- Tighten the two tool fixing screws, also manually.
- Loosen the central nut.
- Remove the spring washer and the flat washer.
- Remove the fixed driving half-pulley.
- Remove the bushing connection washer.

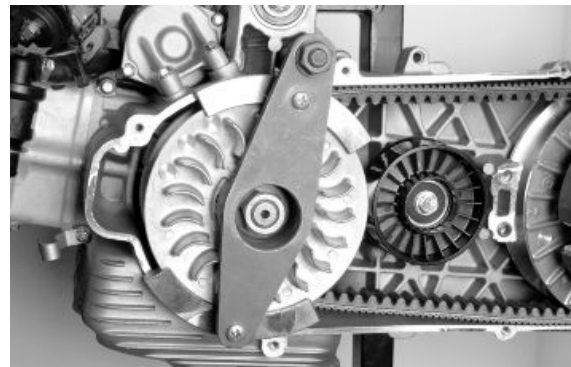

- Move the belt downwards.
- Suitable support the roller contrast and extract the mobile driving half-pulley with the relevant bushing and the rear washer, being careful not to make the rollers come out.



## Inspecting the rollers case

- Check that the inside bushings shown in the figure are not worn and measure the inside diameter.

### CAUTION

**DO NOT LUBRICATE OR CLEAN THE BUSHINGS**

#### Characteristic

##### Maximum admissible diameter:

30.12 mm

##### Standard diameter:

30.021 mm

- Measure the pulley sliding bushing outside diameter shown in the figure.

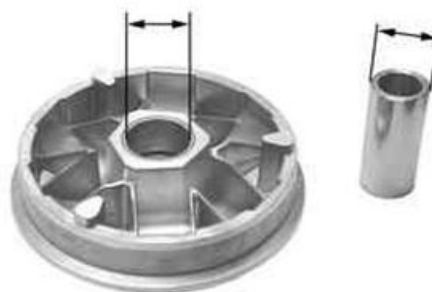

#### Characteristic

##### Minimum admissible diameter

Ø 29.95 mm

##### Standard diameter:

Ø 29.959 mm

- Check that the rollers are not damaged or worn.

#### Characteristic

##### Minimum admissible diameter

Ø 24.5 mm

##### Standard diameter:

Ø 24.9 mm

- 
- Check the guide shoes for the variator back-plate are not worn.
  - Check the wear of the roller housings and of the belt contact surfaces on both pulley halves.



---

## Refitting the driving pulley

### Installing the roller container

- Install the spacer with the internal chamfer facing towards the inside.

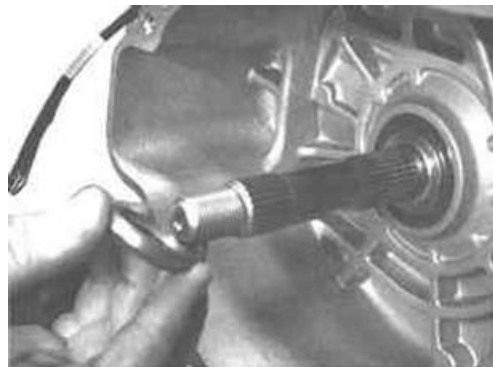

- Position the rollers on the half-pulley as shown in the figure.
- The closed side must rest on the inside thrust face of the roller container.



- Assembly the half-pulley with the roller contrast plate and sliding blocks.



- Insert the half-pulley on the crankshaft.
- Insert the spacer bushing.



#### Installing the fixed driving half-pulley

- Insert the spacer.

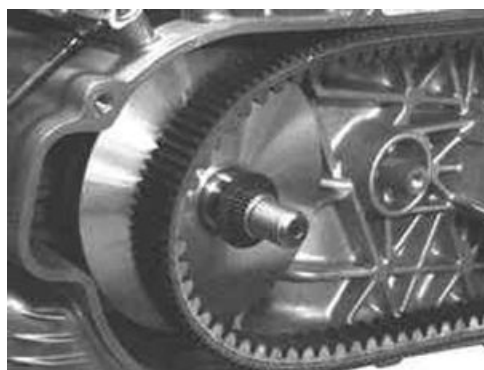

- Install the fixed driving half-pulley and check that it is in contact with the spacer and with the guide bushing of the moving driving pulley.



- Remove the flat washer and the spring washer as shown in the figure.



- Insert the nut in the original position (nut side in contact with the belleville washer).



- Turn the central pulley nut to horizontally align the holes and install the special tool.

**N.B.**

**CHECK THAT THE STOP WRENCH TOOL IS EASILY INSERTED INTO THE PULLEY AND IN THE ENGINE CRANKCASE.**

#### **Specific tooling**

**020474Y Driving pulley lock wrench**



- Install the lock ring from the rear so that the splines are completely engaged.
- Finally install the tool by sliding the nuts by hand and ensuring the tool is resting flatly.
- Tighten the driving pulley fastening nut to the prescribed torque
- Remove the special tool.

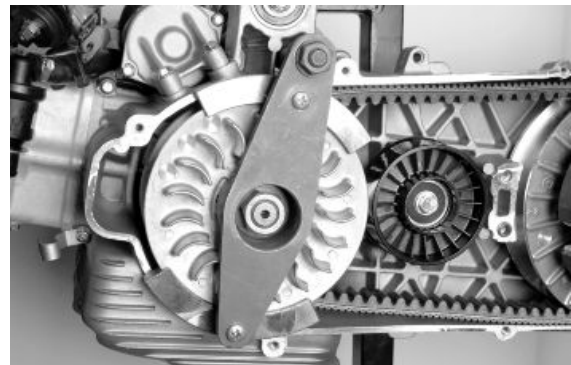

#### **Locking torques (N\*m)**

**Drive pulley nut 160 - 175**

### **Refitting the transmission cover**

- Ensure the correct installation on the crankcase of the 2 centring dowels.



- Insert the transmission cover with the bearing and install the relevant retainers.
- Lock the four M8 retainers.

### Locking torques (N\*m)

**M8 retainers for transmission cover 23 - 26**



- Lock the 7 M6 retainers.

### Locking torques (N\*m)

**M6 retainer 11 ÷ 13**



- Insert the washers on the driven pulley shaft.

**N.B.**

**INSERT THE SMALLER WASHER FIRST, THEN THE LARGER ONE.**

- Insert the flanged nut.
- Prepare the torque wrench for LHS locking using a machine hexagon wrench.
- Tighten the driven pulley shaft fastening nut using an offset wrench.

**N.B.**

**DUE TO THE HIGH TIGHTENING TORQUE, USING DIFFERENT WRENCHES - SUCH AS A CONVENTIONAL POLYGONAL BUSH - MAY DAMAGE THE HEXAGON OBTAINED ON THE SHAFT OR BREAK THE BUSH ITSELF.**

### Locking torques (N\*m)

**Driven pulley nut 92 - 100**

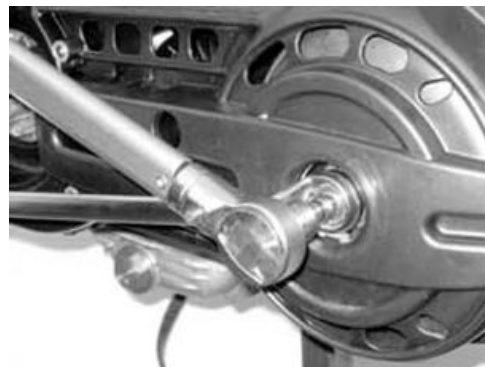

- 
- Install the driving pulley shaft cover, positioning the tooth gap on the lower part with the reference mark on the transmission crankcase.



**N.B.**

**ENSURE THAT THE AIR INTAKE AND EXHAUST OPENINGS ARE COMPLETELY FREE.**

- Install the outside plastic transmission cover.
- Tighten the 4 fastening screws to the prescribed torque.

### **Locking torques (N\*m)**

**Outside transmission cover screws 7 ÷ 9**



---

## **End gear**

---

### **Removing the hub cover**

- Drain the rear hub oil through the oil drainage cap located under the engine.
- Remove the 7 fastening screws. Remove the hub cover and the relevant gasket.

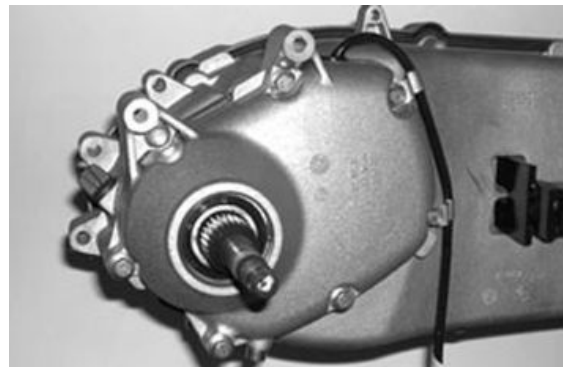

## Removing the wheel axle

- Remove the countershaft.
- Remove the wheel axis complete with gear.

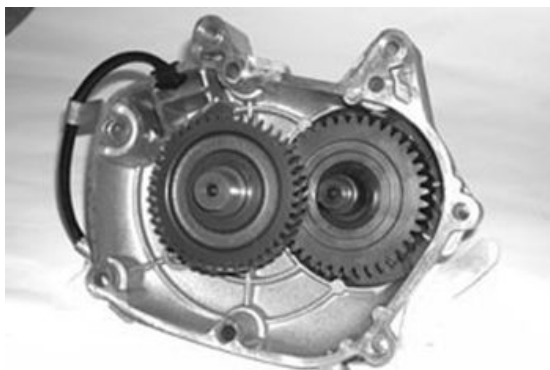

## Removing the hub bearings

- Check all bearings (wear, clearance and noise). In case of anomalies, proceed as follows. To remove the gear shaft bearing on the engine crankcase, use the following parts.

### Specific tooling

**001467Y014 Extraction pliers for  $\varnothing$  15 mm bearings**

**001467Y034 Extraction pliers for  $\varnothing$  15 mm bearings**

**001467Y031 Bell**

- Use the special extractor to disassemble the bearing on the engine chassis of the countershaft.

### Specific tooling

**001467Y006 Extraction pliers for 20 mm bearings**

**001467Y035 Bearing housing outside diameter 47 mm**



- Support the hub cover using the column kit.
- Pull out the bearing using the special tool.

### Specific tooling

**020476Y Stud bolt set**

**001467Y006 Extraction pliers for 20 mm bearings**

**001467Y007 Driver for OD 54 mm bearing**

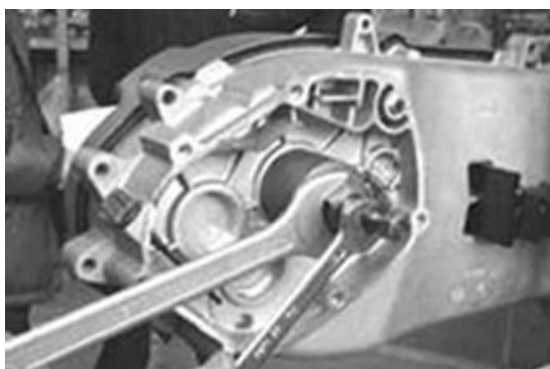



---

## Removing the wheel axle bearings

- Take out the clip on the outside of the gearbox cover.

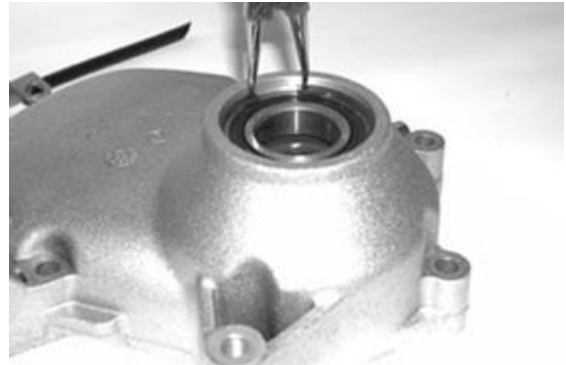

- Support the hub cover using the column kit.
- Pull out the bearing using the special tool.

### Specific tooling

**020476Y Stud bolt set**

**020376Y Adaptor handle**

**020477Y 37 mm adaptor**

**020483Y 30 mm guide**

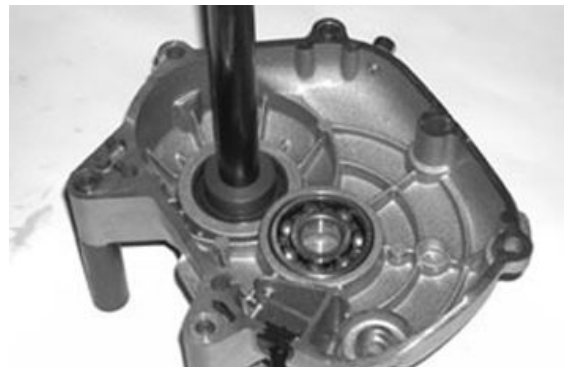

- Remove the oil guard using a screwdriver.



---

## Removing the driven pulley shaft bearing

- If you have to remove the driven pulley shaft, the relevant bearing and the oil guard, remove the transmission cover and the clutch unit as described in the Automatic transmission chapter.
- Extract the driven pulley shaft from its bearing.
- Remove the oil guard using a screwdriver into the hub gear box.
- Remove the seeger ring shown in the figure.



- Pull out the driven pulley shaft bearing from the engine crankcase using the special tool.

### Specific tooling

020376Y Adaptor handle

020358Y 37x40 mm adaptor

020364Y 25 mm guide



## Inspecting the hub shaft

- Check that the 3 shafts exhibit no wear or deformation on the grooved surfaces, at the bearings and at the oil guards.
- In case of faults, replace the damaged parts.

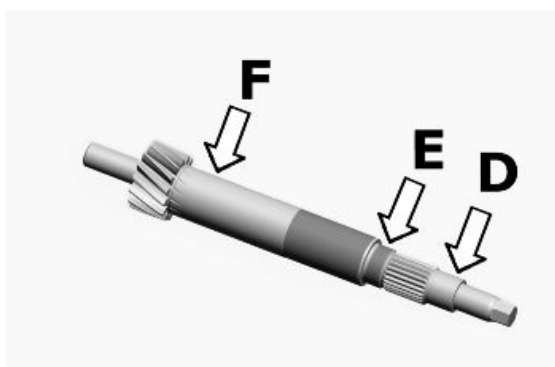
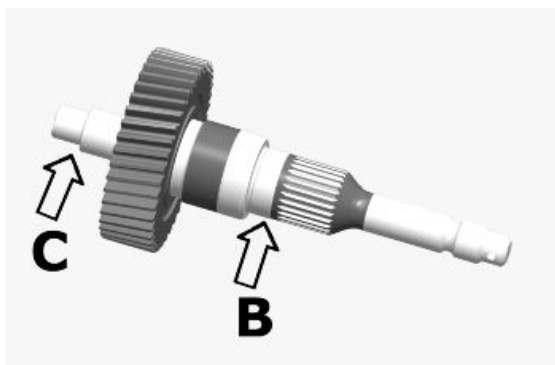
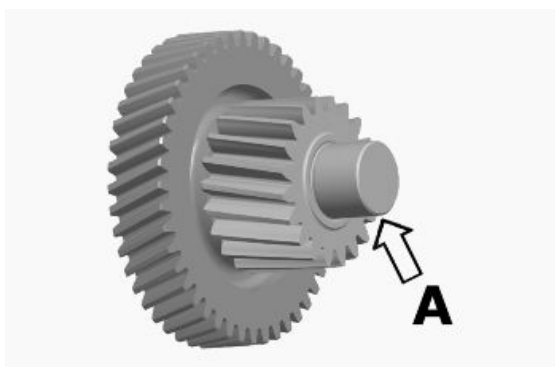

### Characteristic

Connection diameter for countershaft:

A = diameter 20 - 0.01 -0.02 mm

Connection diameter for wheel shaft:

**B** = diameter 30 - 0.010 -0.023 mm

**C** = diameter 15 - 0.01 -0.02 mm

**Connection diameter for shaft driven pulley:**

**D** = diameter 17 - 0.01 -0.02 mm

**E** = diameter 20 - 0.01 -0.02 mm

**F** = diameter 25 - 0.01 -0.02 mm

---

## Inspecting the hub cover

- Check that the mounting surface is not damaged or deformed.
- Check the bearing bearings.

**In case of faults, replace the hub cover.**

---

## Refitting the driven pulley shaft bearing

- Heat the crankcase using the heat gun.

### Specific tooling

**020151Y Air heater**



- Insert the driven pulley shaft bearing until it abuts against the bottom of the seat using the special tool.

**N.B.**

**PLACE IT WITH THE BALLS FACING THE HUB  
(THIS APPLIES TO BEARINGS WITH PLASTIC  
CAGE).**

### Specific tooling

**020376Y Adaptor handle**

**020360Y 52 x 55 mm adaptor**

**020364Y 25 mm guide**



- Heat the intermediate gear bearing seat.
- Insert the intermediate shaft bearing using the special tool.

**N.B.**

**PLACE IT WITH THE BALLS FACING THE HUB (THIS APPLIES TO BEARINGS WITH PLASTIC CAGE).**

#### **Specific tooling**

**020376Y Adaptor handle**

**020359Y 42 x 47 mm adaptor**

**020363Y 20 mm guide**



- Heat the gear shaft bearing seat on the crank-case.
- Insert the gear shaft bearing in the upper crank-case seat using the special tool.

**N.B.**

**PLACE IT WITH THE BALLS FACING THE HUB (THIS APPLIES TO BEARINGS WITH PLASTIC CAGE).**

#### **Specific tooling**

**020376Y Adaptor handle**

**020359Y 42 x 47 mm adaptor**

**020412Y 15 mm guide**



- Place the safety lock seeger ring of the driven pulley shaft bearing.

**N.B.**

**PLACE IT IN THE POSITION SHOWN IN THE FIGURE.**



- Insert the pulley shaft oil guard on the transmission side.



---

## Refitting the hub cover bearings

---

- Heat the bearing seats on the cover using the heat gun.
- Support the hub cover using the column kit.

### Specific tooling

**020151Y Air heater**

**020476Y Stud bolt set**

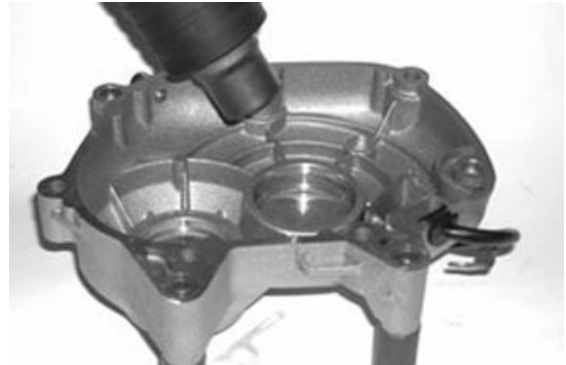

- Insert the intermediate shaft bearing on the cover using the special tool.

**N.B.**

**PLACE IT WITH THE BALLS FACING THE HUB (THIS APPLIES TO BEARINGS WITH PLASTIC CAGE).**

### Specific tooling

**020376Y Adaptor handle**

**020360Y 52 x 55 mm adaptor**

**020363Y 20 mm guide**

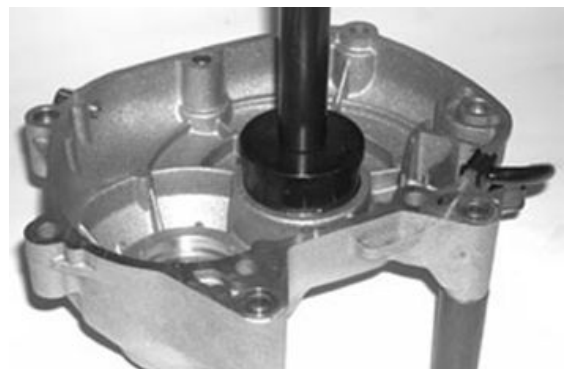

- Heat the gear shaft bearing seat from the cover outside.
- Insert the gear shaft bearing on the cover using the special punch until abutment.

### Specific tooling

**020376Y Adaptor handle**

**020360Y 52 x 55 mm adaptor**

**020483Y 30 mm guide**

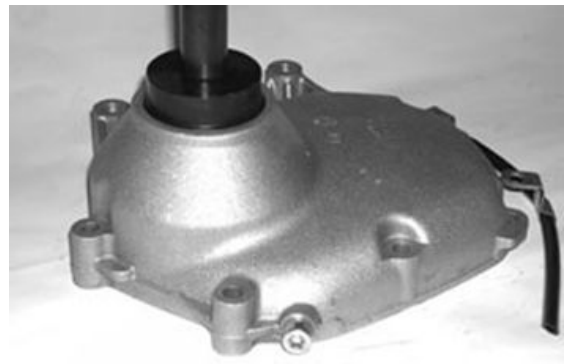

- Replace the snap ring



- Support the hub cover using the column kit.
- Insert the wheel shaft oil guard with the sealing lip facing the inside of the cover.
- Place the oil guard flush with the crankcase.

### Specific tooling

**020376Y Adaptor handle**

**020360Y 52 x 55 mm adaptor**

**020476Y Stud bolt set**



## Refitting the hub bearings

- Place the 3 shafts as shown in the figure.



## Refitting the hub cover

- Check the proper position of the centring dowels.
- Install a new gasket.
- Fit the gearbox cover, making sure the breather pipe is in the correct position.



- Position the 7 set screws, tighten them to the prescribed torque, being careful of the position of the bands holding the vent tube, and the position of the 3 shortest screws as indicated in the figure.
- Refill with the prescribed oil to the Max. level.

### Recommended products

**AGIP ROTRA 80W-90 rear oil hub**

SAE 80W/90 Oil that exceeds the API GL3 specifications

### Characteristic

**Quantity:**

approx. 250 cc

**Locking torques (N\*m)**

Rear hub cover screws 24 ÷ 27

**Flywheel cover**

- Remove the three bands shown in the figure for an easier removal of the flywheel cover, remove the feed hoses and disconnect the return hose from the pump cover.

**N.B.**

**THE BANDS MUST BE REPLACED. TO REMOVE THEM, OPEN WITH A SCREWDRIVER OR CUT THEM. BE CAREFUL NOT TO DAMAGE THE PLASTIC UNIONS.**

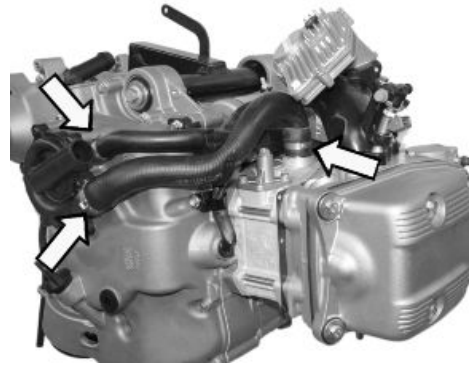
**Removing the hub cover**

- Drain the engine oil by removing the drainage cap.
- Prepare a suitable container to collect the oil.



- Remove the pre-filter.



- Remove the oil filter using a filter tape or shaped cup wrench.



- Loosen the 14 fastening screws.
- Remove the flywheel cover with the relevant gasket and the cooling system sleeve support.

**N.B.**

**THE SCREWS ARE OF 4 DIFFERENT LENGTHS. NOTE THE RELEVANT POSITIONS.**

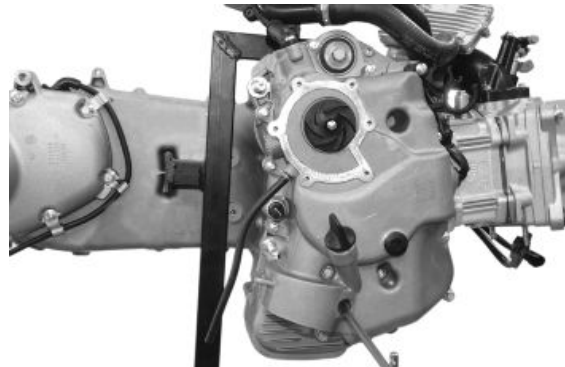

**CAUTION**

**REMOVE THE COVER AVOIDING ANY POSSIBLE INTERFERENCE BETWEEN STATOR AND ROTOR.**

**CAUTION**

**BE CAREFUL TO PREVENT SLIPPAGE OF THE BY-PASS VALVE AND OF THE RELEVANT SPRING.**

## Removing the flywheel cover components

- Loosen the six mounting screws and remove the water pump cover.

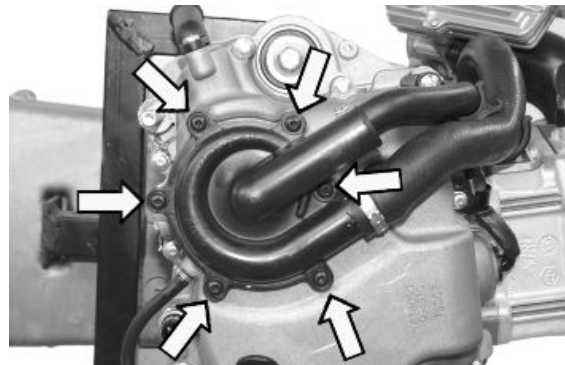



- Remove the by-pass and the relevant spring.
- Remove the oil pump seal.



### Removing the stator

- Remove the two retaining screws and the cable guide bracket.

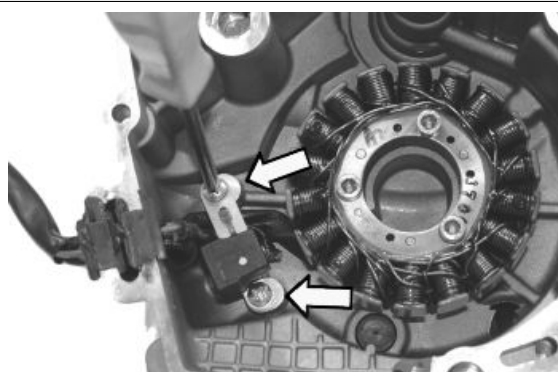

- Unscrew the 3 fastening screws and remove stator and its wiring.



### Inspecting the cover components

- Loosen the two retaining screws and remove the reed valve support with bulkhead.



- 
- Remove the blow-by reed valve with the relevant sealing gasket.

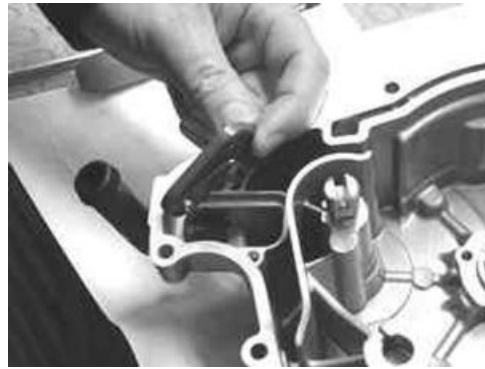

- 
- Unscrew the fastening screw and remove the gas outlet union with the relevant O-ring.



- 
- Check that the mounting surface of the crankcase is not worn or deformed.
  - Check that the by-pass valve seat, the torque limiter and the water pump shaft are free from wear.

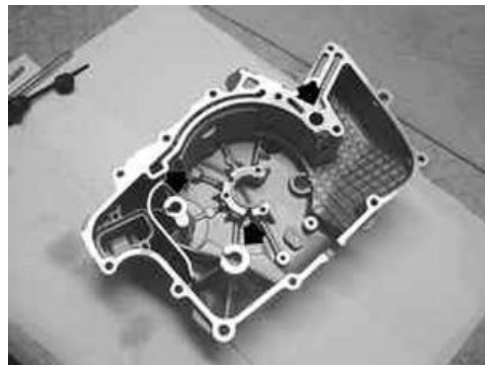

### **Characteristic**

#### **By-pass housing hole diameter:**

13.9 mm

#### **Connection diameter for start-up gear shaft:**

12 mm

#### **Connection diameter for pump shaft:**

8 mm

- 
- Check that the oil filter union and matching surface exhibit no deformations or wear.

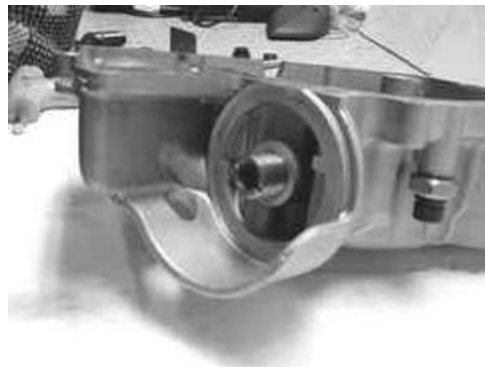

- 
- Check the condition of the stator and of the respective cable harness.



- 
- Check the continuity between the 3 phases.

**N.B.**

**VALUES ARE STATED AT AMBIENT TEMPERATURE. A CHECK WITH THE STATOR AT OPERATING TEMPERATURE MAY RESULT IN VALUES HIGHER THAN THOSE STATED.**

**Electric characteristic**

**Resistance:**

0.2 - 1  $\Omega$



- 
- Check the earth insulation of each phase.
  - If a fault is discovered, carry out a close check of the cable harness that contains two types of cable: Rigid cables close to the stator and flexible cables close to the connector.



- 
- Check that the winding is positioned so as not to interfere with the heads of the retaining screws.



## Refitting the stator

- Install the stator assembly together with the wiring harness, tightening the 3 screws to the prescribed torque.

**N.B.**

**INSERT THE RUBBER WIRING SEALING GASKET INTO THE SPECIAL SEAT ON THE CRANKCASE.**

**Locking torques (N\*m)**

**Stator retainers 8 - 10**



- Install the wiring guide bracket tightening the 2 screws to the prescribed torque.

**Locking torques (N\*m)**

**Stator cable harness guide bracket screws 3 - 4**

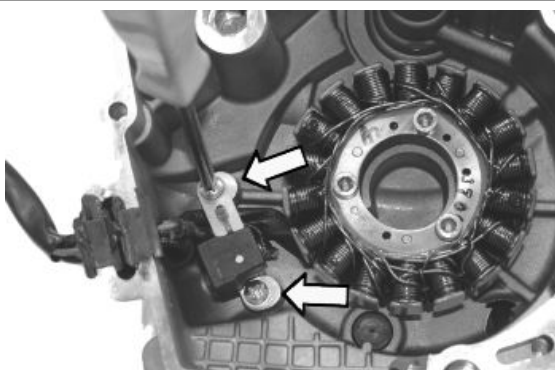

## Refitting the flywheel cover components

- Before reassembling, check that all components are perfectly clean.
- For the cover, carefully check all lubrication channels, in particular:
  - The 3 by-pass channels.



- Oil pressure sensor feeding duct.



- Oil vapour decantation chamber

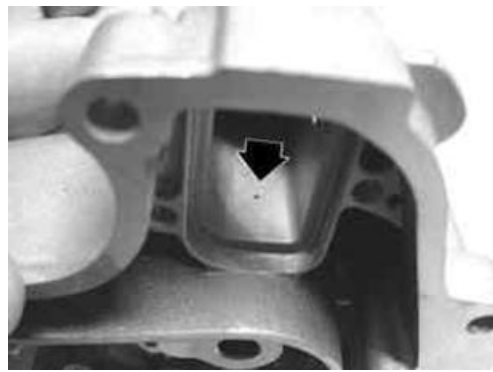

- Temporarily install the distribution timing check hole cover and the engine oil filling cap/bar.
- Insert the blow-by recovery duct using a new O-ring.
- Tighten the screws to the prescribed torque.



#### Locking torques (N\*m)

**Blow-by recovery duct fixing screws 3 - 4**

- Insert the spring and the by-pass piston on the flywheel cover.

**N.B.**

**LUBRICATE THE BY-PASS VALVE.**



- Reinstall the blow-by reed valve using a new sealing gasket.
- Reinstall the support with head and tighten the screws to the prescribed torque.

#### Locking torques (N\*m)

**Supporting screws with bulkhead 0.3 - 0.4**



- Correctly fit a new O-ring, do not allow it to come into contact with grease or oil.

**FAILURE TO OBSERVE THIS ADVICE CAN IRRETRIEVABLY DEFORM THE O-RING.**

- Refit the water pump cover and tighten the 6 fixing screws to the prescribed torque.

### Locking torques (N\*m)

Pump cover fixing screws: 3 ÷ 4



## Refitting the flywheel cover

- Install a new oil filter, lubricate the gasket, screw on and finally tighten to the prescribed torque.

### Locking torques (N\*m)

Engine oil filter 12 - 16



- Install the supply hose to the cylinder and connect the return hose to the pump cover using 3 new clamps.

**N.B.**

**TIGHTEN THE CLAMPS USING APPROPRIATE PLIERS, PAYING ATTENTION NOT TO CONSTRICT THE HOSES BUT ALSO TAKING CARE TO TIGHTEN THE CLAMPS SUFFICIENTLY.**

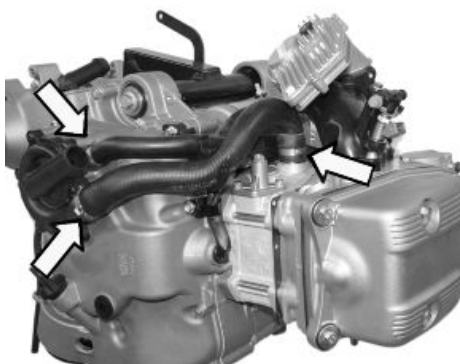

- Install the pre-filter again and insert the engine oil drain plug, tightening to the prescribed torque.
- Refill the engine with the prescribed type of oil.

### Recommended products

**AGIP CITY HI TEC 4T Engine oil**

SAE 5W-40, API SL, ACEA A3, JASO MA Synthetic oil

### Locking torques (N\*m)

Engine oil drainage plug 24 ÷ 30



- Lubricate the intermediate gear seat with torque limiter on the flywheel cover.
- Align the water pump movement sensor with a reference and install the flywheel cover as described in the Flywheel cover chapter.

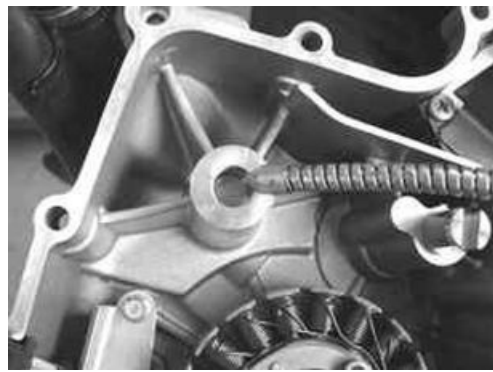

- Install a new gasket on the engine crankcase.
- Check the presence of the three centring dowels.



- Turn the crankshaft in order to align the counter-shaft movement sensor with a reference point on the crankcase (see figure).



- Repeat the alignment for the water pump crankshaft using the same reference point on the engine.

**N.B.**

**THIS PREPARATION IS USEFUL PARTICULARLY IN THE EVENT OF REPAIRS WITH THE WATER PUMP COVER INSTALLED.**



- Install the flywheel cover on the engine, paying attention to avoid interference between the stator and rotor.

**WARNING**

**FAILURE TO OBSERVE THIS INSTRUCTION MAY RESULT IN DESTRUCTION OF THE CERAMIC MAGNETS.**

- Tighten the 14 retaining bolts of the cover to the prescribed torque.

**N.B.**

**THE BOLTS HAVE FOUR LENGTHS:**

- THE 3 SHORTEST ARE INSERTED AS SHOWN IN THE FIGURE.
- THE LONGEST IS INSERTED UNDER THE ENGINE OIL FILLER PLUG.

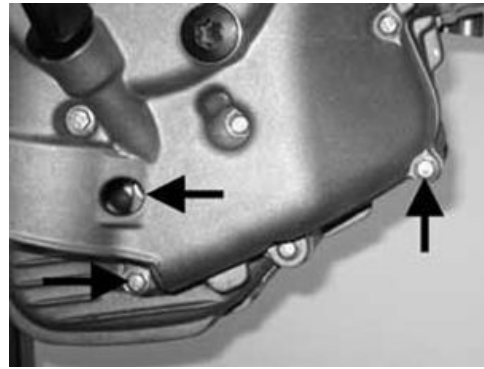

**N.B.**

- THE INTERMEDIATE BOLTS FOR THE REMAINING MOUNTING POINTS WITH THE EXCEPTION OF THE BOLT FOR THE MANIFOLD SUPPORT (SHOWN IN THE FIGURE) ARE SLIGHTLY LONGER.

**Locking torques (N\*m)**

**Flywheel cover screws 11 - 13**



## Flywheel and starting

- Remove the three bands shown in the figure for an easier removal of the flywheel cover, remove the feed hoses and disconnect the return hose from the pump cover.

**N.B.**

**THE BANDS MUST BE REPLACED. TO REMOVE THEM, OPEN WITH A SCREWDRIVER OR CUT THEM. BE CAREFUL NOT TO DAMAGE THE PLASTIC UNIONS.**

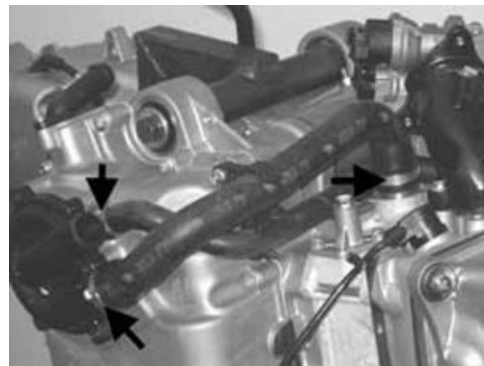

The starter is sold as a complete part.

Before deciding to replace it, carry out the following tests:

1 - Battery

Check the voltage after not running (a few hours):

Voltage >12.5V

Check the density of the electrolyte of each cell:

Bé = 30 ÷ 32

Specific weight: 1.25 - 1.26

YES go to 2 NO go to 3





2 - Make sure the negative terminals (battery negative and starter negative) are correctly connected to each other and to the frame.

YES go to 4 NO go to 5

3 - Recharge and if necessary replace the battery.

4 - Connect the diagnostic tester (see chapter "Injection system").

Connect the induction clamp of an ammeter to the positive power supply cable of the starter motor.

Remove the 10A fuse no. 12 (see "fuses" chapter).

Switch in position "ON" with interrupt switch in position "RUN" and side stand raised.

Select the "PARAMETERS" function.

Start the engine (so that it cannot move) long enough to measure the rpm and starter absorption.

**N.B.**

**THE DECLARED RPM VALUE IS THAT INDICATED BY THE TESTER, THE RPM READING IS NOT THE REAL ONE, BUT IS VALID FOR DIAGNOSTIC PURPOSES.**

### Specific tooling

**020460Y Scooter diagnosis and tester**

#### Electric characteristic

##### Absorption at trailing speed:

80 - 120 A

##### Revolution speed =

approx. 300-400 rpm

YES go to 6 NO go to 7 NO go to 8 NO go to 9



5 - Restore the connections

#### 6- The values are correct.

Finally carry out a check of the power consumption at idle speed.

Remove the starter motor (see the flywheel and starter system).

Reconnect the earth and positive and perform the test.

#### Electric characteristic

##### Current consumption at idle speed:

<40 A

YES go to 10 NO go to 11

**7- Low trailing speed****High electrical absorption**

Carry out a test of the engine rotation (example: possible melting of the bushes) and if no anomalies are found, replace the starter motor.

**8- Low trailing speed****Low electrical absorption**

Repeat the test, bridging the power terminals of the starter remote control switch or even better replacing them.

Check the new values.

YES go to 12 NO go to 13

**9 - High trailing speed****Low electrical absorption**

The engine turns too freely, check the compression end pressure.

If the values are not correct proceed as follows.

10 - The starter motor works properly.

11 - Check the rotation of the armature.

12 - Replace the starter remote control switch.

13 - Test the battery again and if necessary replace the starter motor.

**N.B.**

**IF THE TRAILING SPEED OF THE CRANKSHAFT IS LOW AND COMBINED WITH STRANGE NOISE, CHECK THE FREEWHEEL OF THE TORQUE LIMITER (SEE THE "FLYWHEEL AND STARTER SYSTEM" CHAPTER).**

**STARTER MOTOR**

Specification	Desc./Quantity
Type	Mitsuba sm13d
Power	0.9 kW

**BATTERY**

Specification	Desc./Quantity
Capacity	14 Ah
Starting current	125 A

**START-UP REMOTE CONTROL SWITCH**

Specification	Desc./Quantity
Type	SEALED
Maximum load	150 A continuous

**STARTER TRANSMISSION**

Specification	Desc./Quantity
Ring gear and freewheel coaxial to the flywheel.	Intermediate gear with built-in torque limiter.

The starter system has a transmission between the motor armature and engine shaft equipped with freewheel coaxial to the flywheel and torque limiter on the intermediate shaft.

The limiter is calibrated to 10 kgm (100 Nm); this component protects the structure of the engine and the starter kinematic mechanism in the event of incorrect starting with consequent inverse rotations.

The freewheel is used for a sufficiently silent starting.

The starter control (energised remote control) is slaved to enabling signals by the side stand and the emergency OFF/RUN switch, which does not allow starting given dangerous conditions.

The starter control circuit is not controlled by the immobilizer system, therefore before insisting on the starter system, check the consensus of the immobilizer.

As for checking the consensus circuit, see the "Electrical system" chapter, while for checking the engine shaft control transmission, follow what is described in the "Flywheel and starter system" chapter.

---

## Removing the starter motor

**N.B.**

**THIS OPERATION MAY ALSO BE CARRIED OUT WITH FLYWHEEL COVER ASSEMBLED.**

- Loosen the two fastening screws.
- Extract the complete starter motor.



---

## Removing the flywheel magneto

**N.B.**

**IF YOU MUST REMOVE THE FLYWHEEL, IT IS NECESSARY TO REMOVE THE CHAIN GUIDE SLIDING BLOCK RETAIN PLATE FIRST.**

- Unscrew the 3 fastening screws and remove the chain guide sliding block retain plate and the start-up rim.

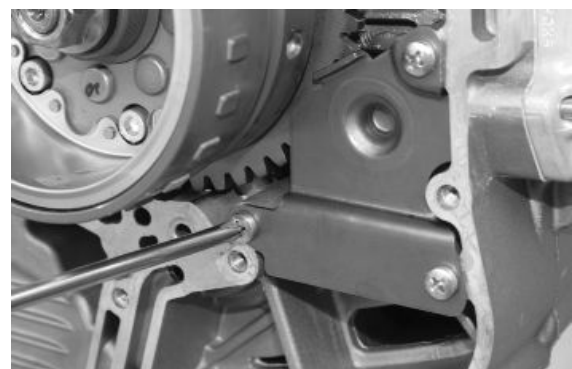

- 
- Align the holes obtained on the flywheel with the crankcase housing to allow the introduction of the special tool.

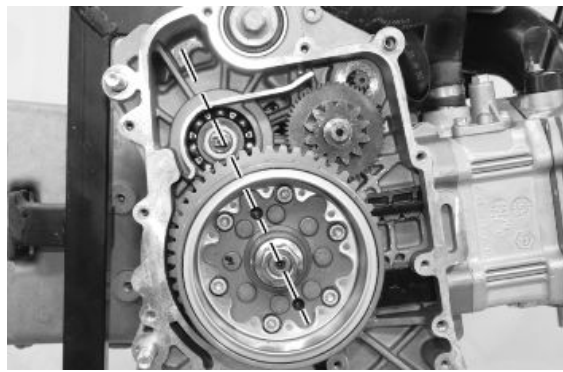

- 
- Tighten the bushing of the flywheel lock tool on the removing tool threading.



- 
- Insert the special tool as shown in the figure, making sure that the pins are perfectly inserted into the previously aligned holes and that it is perfectly abutted and almost flush with the flywheel.

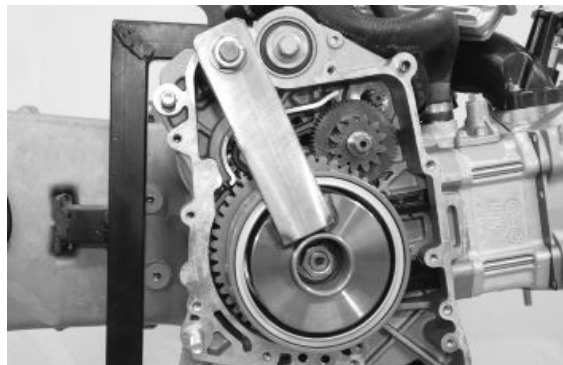

### **Specific tooling**

**020472Y Flywheel lock wrench**

- 
- Loosen the magneto flywheel fastening nut.
  - Remove the special tool and the fastening nut.



- Remove the washer.



- Insert the nut again so as to slightly uncover the shaft and free the space that was occupied by the washer.

**CAUTION**

**THIS OPERATION IS REQUIRED AS THE FLYWHEEL IS STRONGLY LOCKED; THE CONE DETACHMENT MAY THEREFORE CAUSE THE ROTOR SLIPPAGE, WITH THE CONSEQUENT BREAKAGE OF THE MAGNETS.**



- Insert the special removing tool.
- Using a 27-mm wrench and a 19-mm bushing, release the flywheel.

**Specific tooling**

**020467Y Flywheel extractor**



- Remove the extractor.
- Remove the nut and extract the flywheel with the start-up rim.
- Remove the crankshaft key.



- 
- To remove the start-up rim from the freewheel it is necessary to turn it clockwise and pull it out.



- 
- Remove the freewheel from the flywheel by loosening the 6 fastening screws.

**SINCE THE FREEWHEEL MUST BE REMOVED, IT IS ADVISABLE TO LOOSEN THE 6 FASTENING SCREWS IN ADVANCE WITH THE FLYWHEEL STILL INSTALLED ON THE CRANK-SHAFT.**



- 
- The freewheel is coupled to the flywheel with high precision; if removal is difficult, use 2 screws as gripping points and as removing tools, if required.



- 
- Extract the intermediate gear provided with torque limiter.



## Inspecting the flywheel components

- Check the integrity of the magnets.
- Check that the magnet support cage is free from deformation or cracks.
- Check that the flywheel splines exhibit no loosening.



## Starter gear rim

- Check that there is no wear or abnormal impressions on the "rollers" of the freewheel and on the surface of the starter ring gear hub.
- Check the hub outside diameter.

### Characteristic

#### Hub outside diameter:

Diameter  $45.665 + 0.008 + 0.005$  mm

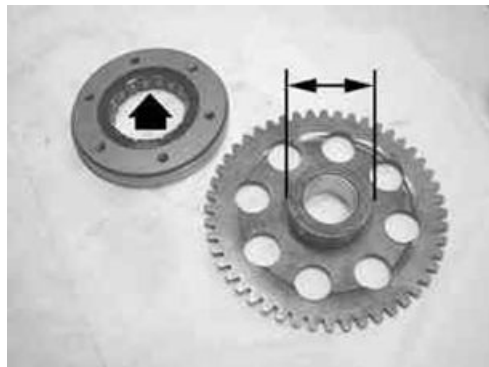

- Check the inside diameter of the bushing of the starter gearing.
- Check that the tothing is not worn.

### Characteristic

#### Inside diameter of the bushing:

Diameter  $27 + 0.020 + 0.041$  mm



### N.B.

**IF THE FAULTS DISCOVERED AFFECT THE HUB, REPLACE THE STARTER RING GEAR AND FREEWHEEL.**

**IF ONLY THE BUSHING IS WORN, IT IS POSSIBLE TO REPLACE ONLY THE COMPLETE START-UP RIM. IN THAT CASE, CHECK ALSO THE DIAMETER AND THE SURFACE OF THE CONNECTION ON THE CRANKSHAFT. IN CASE OF IRREGULARITIES, REPLACE THE CRANKSHAFT.**

## Intermediate gear

- Check that the tothing is not worn.
- Check the diameter of the two bearings.

### Characteristic

#### Diameter of gear bearing:

12 - 0 0.011 mm



Also check the shaft diameter on the flywheel cover and on the engine crankcase.

### Characteristic

#### Shaft diameter on the flywheel cover

12 + 0.034 -0.016 mm

#### Shaft diameter on the engine crankcase:

12 + 0.034 -0.016 mm

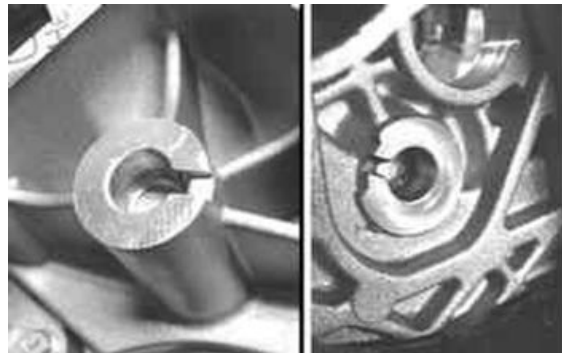

### N.B.

**THE TORQUE LIMITER IS PROVIDED WITH 4 GEARS THAT HAVE THE FUNCTION OF CLUTCH DRIVE PLATES.**

Driven plates consist of 4 Belleville springs provided with grooved profiles; this assembly allows transmitting torque lower than 10 kgm.

In case of incorrect start-up manoeuvres, the limiter prevents any kicks, with consequent reversal of direction of the crankshaft which would impair the engine structure.



The limiter assembly cannot be overhauled. In case of irregularities on the toothed discs, replace the assembly.

## Refitting the free wheel

- Make sure the free wheel contact surfaces are in good condition.
- Thoroughly clean the free wheel to remove LOCTITE residue.
- Degrease the threading of the holes in the free wheel and the clamping screws.
- Apply the recommended product to the end of the screws.

### Recommended products

**Loctite 243 Medium strength threadlock**



---

Medium Loctite 243 threadlock

- Fit the freewheel on the magneto flywheel making sure that the ground side is in contact with the flywheel itself, i.e. with wheel Seeger ring visible.
- Lock the six clamping screws in criss-cross fashion to the prescribed torque.

**Locking torques (N\*m)****Screw fixing freewheel to flywheel 13 - 15**

- 
- Oil the free wheel "rollers".

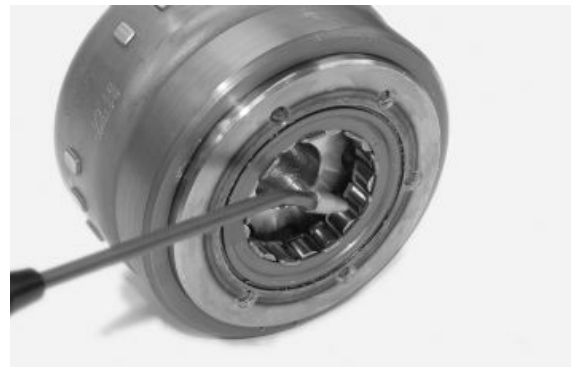

---

**Refitting the intermediate gear**

- 
- Lubricate the gear housing on the engine crankcase.



- 
- Insert the intermediate gear with torque limiter



- 
- Lubricate the inside bushing and the starter ring gear hub surface.



- 
- Install the start-up rim on the flywheel turning it clockwise and inserting at the same time.



---

## Refitting the flywheel magneto

- Insert the key on the crankshaft.
- Install the flywheel checking the proper insertion of the key and engaging the torque limiter gear with the start-up rim.



- Insert washer and nut on the crankshaft.



- 
- Tighten thoroughly the guide bushing of the flywheel lock tool and loosen by 1/4 turn.

**N.B.**

**FAILURE TO OBSERVE THIS RULE CAUSES THE LOCKING OF THE GUIDE ON THE FLYWHEEL.**

**Specific tooling**

**020472Y Flywheel lock wrench**



- 
- Align the 2 holes of the flywheel with the case housing to allow the introduction of the special tool.

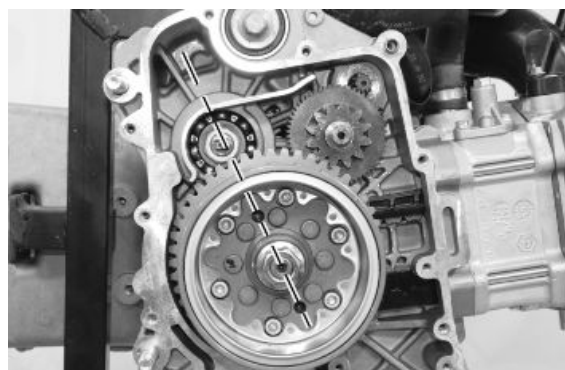

- 
- Insert the special tool checking that the pins are perfectly introduced into the seat.

**Specific tooling**

**020472Y Flywheel lock wrench**

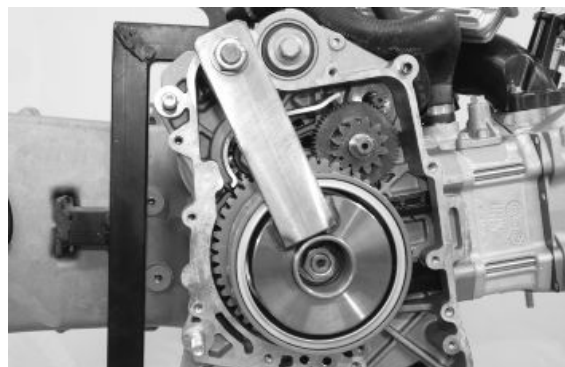

- 
- Tighten the flywheel lock nut to the prescribed torque.

**Locking torques (N\*m)**

**Flywheel fixing nut 115 - 125**



- Install the chain guide retain plate tightening the 3 screws to the prescribed torque.

**N.B.**

**BEFORE TIGHTENING THE SCREWS, MOVE THE START-UP RIM IN CONTACT WITH THE CRANKCASE AND CHECK THAT IT IS FREE TO ROTATE IN ANTICLOCKWISE DIRECTION.**

**Locking torques (N\*m)**

**Chain guide sliding block retain plate fastening screws 3 ÷ 4**



## Refitting the starter motor

- Check that the O-ring is in good working order and lubricate it.
- Insert the starter motor.
- Tighten the 2 fastening screws to the prescribed torque.

**Locking torques (N\*m)**

**Starter screws 11 ÷ 13**



## Cylinder assy. and timing system

- Remove the external and internal transmission cover.



- Remove the flywheel cover, the flywheel and the torque limiter.

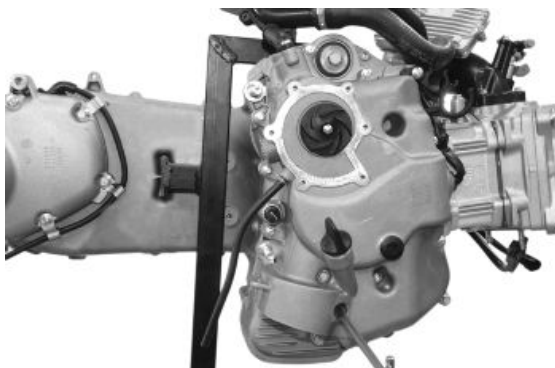

**Removing the intake manifold**

---

- Remove the 3 mounting screws.
- Remove the intake manifold unit.

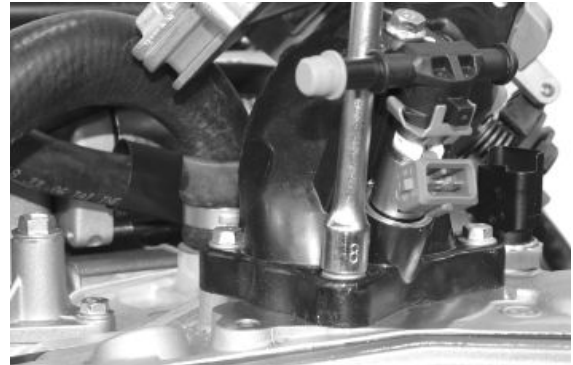
**Removing the rocker-arms cover**

---

- Loosen the 6 special screws with stop and the relevant rubber gaskets.
- Remove the tappet cover with relevant gasket.

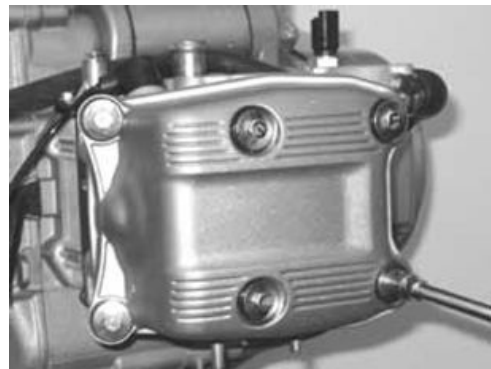
**Removing the timing system drive**

---

- Turn the engine to close the intake valves.

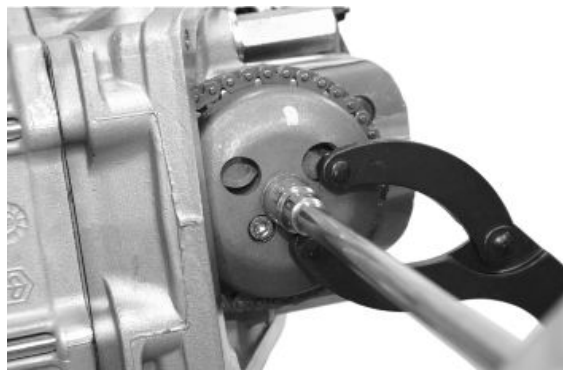

- 
- Remove the central screw and the valve lifting device mass stop bell using the special tool.

**Specific tooling****020565Y Flywheel lock calliper spanner**

- 
- Remove the return spring and the valve lifting mass with relevant travel end washer.

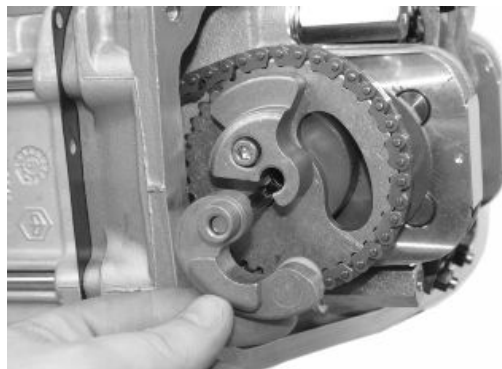
**N.B.****BE CAREFUL NOT TO ALLOW THE WASHER AND SPRING TO FALL INTO THE ENGINE THROUGH THE CHAIN COMPARTMENT.**

- 
- Align the reference marks on the timing chain rim with those on the head.



- 
- Loosen the central screw on the tensioner first.
  - Unscrew the 2 fastening screws and remove the tensioner with relevant gasket.

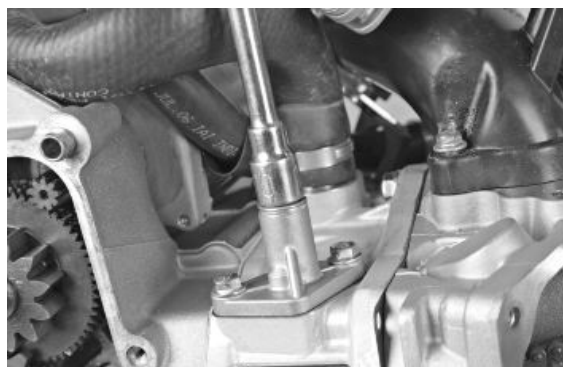

---

Remove the inside hexagon screw and the counterweight as shown in the figure.

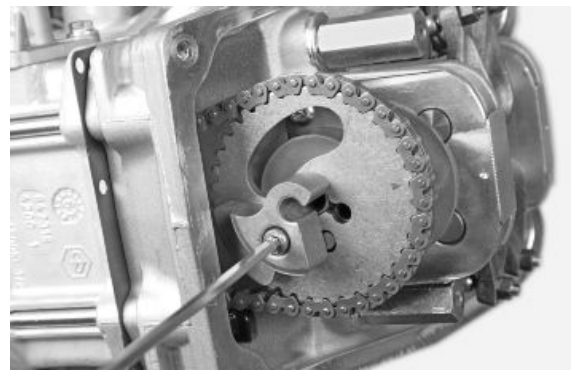

- 
- Remove the timing belt rim from the camshaft.
  - Remove the timing belt rim.

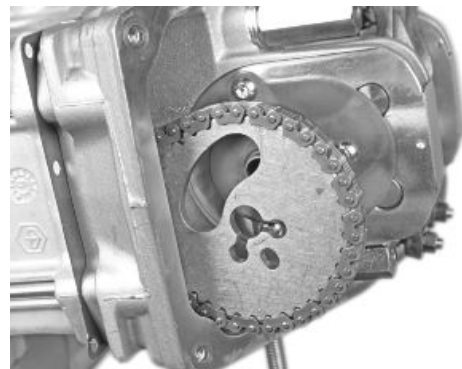

---

### Removing the cam shaft

- 
- Unscrew the 3 fastening screws and remove camshaft retaining bracket.

**N.B.**

**REMOVING THE FASTENING SCREWS MAY BE DIFFICULT. BE CAREFUL NOT TO DAMAGE THE INSIDE HEXAGON. IF NECESSARY, SEPARATE THE THREADS IN ADVANCE.**

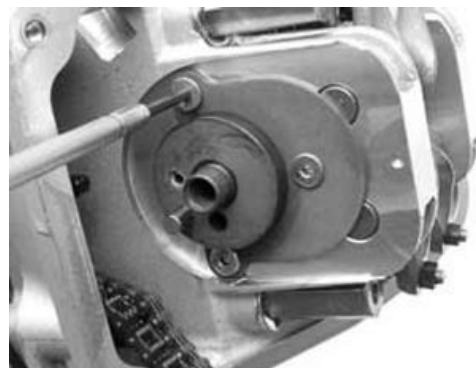

- 
- Remove the cam shaft.



- Remove pins and rocking levers by the transmission side holes.

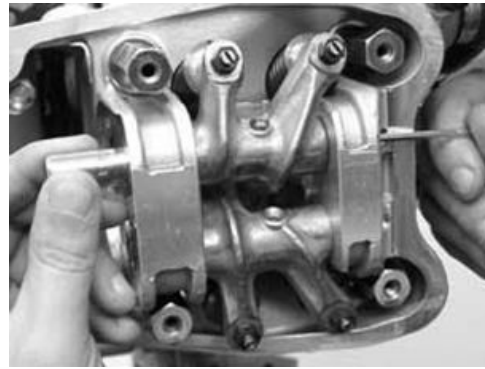

## Removing the cylinder head

- Remove the spark plugs.
- Remove the cooling system outlet sleeve with thermostat.



- Remove the coolant temperature sensor.

**N.B.**

**THE SENSOR CONTROLS BOTH INJECTION AND THE ANALOGUE INSTRUMENT ON THE PANEL. TO CHECK THIS COMPONENT, SEE THE INJECTION CHAPTER.**



- Remove the 2 fastening nuts on the head, on the exhaust and on the intake side.

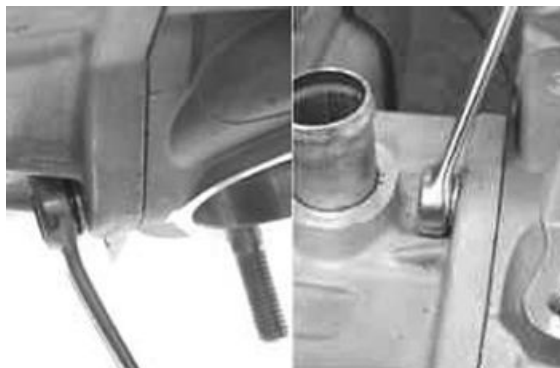



- Remove the two M6 screws into the distribution channel and the M6 screw on the spark plug side with the thermostat support.

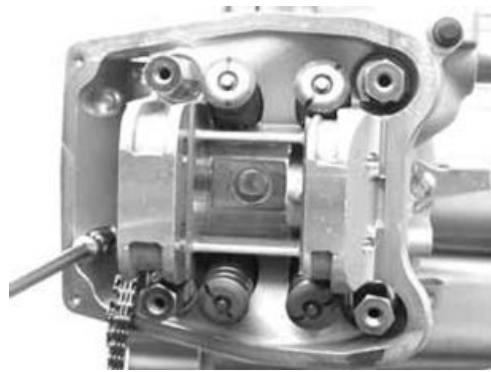

**N.B.**

**IF NECESSARY, THE HEAD MAY BE REMOVED WITH THE CAMSHAFT, PINS, ROCKING LEVERS AND MOUNTING BRACKET.**

- Loosen the 4 head-cylinder fastening nuts in 2 or 3 times and in a crossed sequence.
- Remove the head, the 2 centring dowels, the gasket and the lower chain guide sliding block.

**N.B.**

**DO NOT REMOVE THE DOWELS IF THEY ARE FORCED INTO THEIR SEAT.**



**CAUTION**

**WHEN YOU HAVE TO REMOVE THE HEAD, PREPARE A SUITABLE CONTAINER SINCE THE THERMAL UNIT CONTAINS COOLANT.**

## Removing the valves

- Using the appropriate tool fitted with an adapter, remove the cotters, washers, springs and valves.

### Specific tooling

**020382Y Valve cotters equipped with part 012 removal tool**

**020382Y012 bush (valve removing tool)**



**CAUTION**

**ARRANGE THE VALVES SO AS TO RECOGNISE THE ORIGINAL POSITION ON THE HEAD (FLY-WHEEL SIDE AND TRANSMISSION SIDE).**

- Remove the oil guards using the special tool.

### Specific tooling

020431Y Valve oil seal extractor



- Remove the spring supports.

**N.B.**

**BLOW THE SEATS WITH COMPRESSED AIR TO FACILITATE THE SPRING SUPPORT REMOVAL.**



## Removing the cylinder - piston assy.

- Remove the timing chain.
- Loosen the fastening screw and remove the spacer and the tightening sliding block.

**N.B.**

**IT IS ADVISABLE TO MARK THE CHAIN IN ORDER TO ENSURE THAT THE INITIAL DIRECTION OF ROTATION IS MAINTAINED.**



- Extract the cylinder with the relevant gasket and the centring dowel.

**N.B.**

**THE SECOND CENTRING IS ENSURED BY A PIN SET INTO THE CYLINDER.**

**CAUTION**

**TO PREVENT DAMAGES TO THE PISTON, SUPPORT IT WHILE REMOVING THE CYLINDER.**

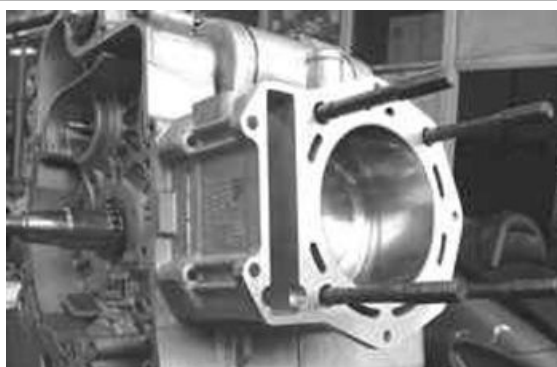

- Remove the 2 piston pin locking rings by the specific housings.
- Extract the pin and remove the piston.

**N.B.**

**USE PAPER OR A CLOTH TO CLOSE THE CYLINDER HOUSING MOUTH ON THE CRANKCASE TO PREVENT SLIPPAGE OF ONE OF THE PIN LOCKING RINGS INTO THE CASE.**



- Remove the piston sealing rings and the oil scraper.

**CAUTION**

**NOTE THE ASSEMBLY POSITIONS OF THE LININGS TO PREVENT INVERTING THE POSITION IN CASE OF REUSE.**

**N.B.**

**BE CAREFUL NOT TO DAMAGE THE SEALING RINGS DURING REMOVAL.**



## Inspecting the small end

- Using a bore gauge, measure the connecting rod small end diameter.

**N.B.**

**IF THE CONNECTING ROD SMALL END DIAMETER EXCEEDS THE STANDARD DIAMETER, EXHIBITS WEAR OR OVERHEATING, PROCEED TO REPLACE THE CRANKSHAFT AS DESCRIBED IN CHAPTER CRANKCASE AND CRANKSHAFT.**

**Characteristic**

**Standard diameter:**

22 + 0.025 +0.015 mm

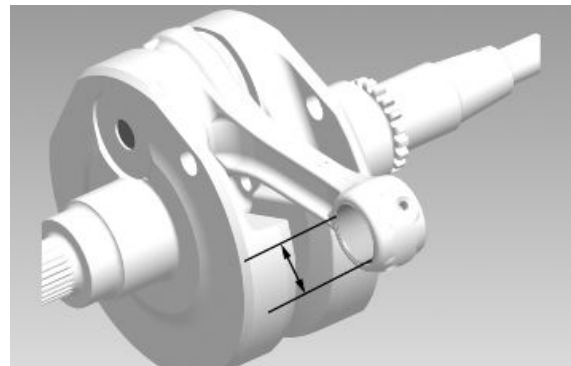

## Inspecting the wrist pin

- Check the pin outside diameter using a micrometer.

**Characteristic**

**Standard diameter:**

22 0 - -0.004 mm

- Calculate the coupling clearance between pin and connecting rod end.

**Characteristic****Standard clearance:**

0.015 ÷ 0.029 mm

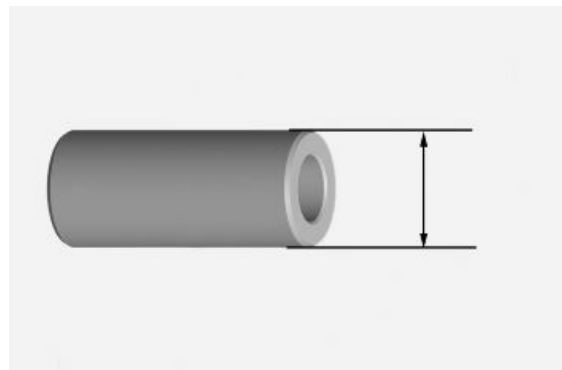
**Inspecting the piston**

- Measure the capacity diameter on the piston.

**Characteristic****Standard diameter:**

22 + 0.006 +0.001mm

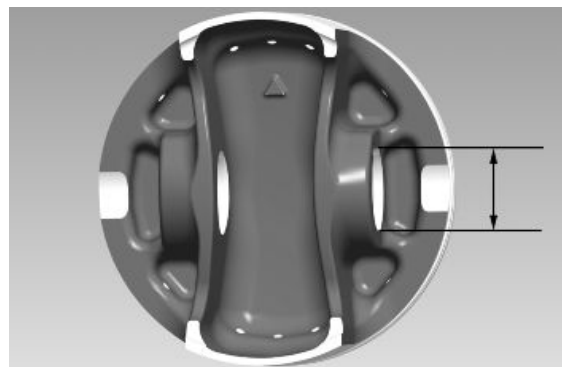

- Calculate the piston pin coupling clearance.

**N.B.**

**THE PIN HOUSINGS HAVE 2 LUBRICATION CHANNELS. FOR THIS REASON, MEASUREMENT MUST BE MADE ACCORDING TO THE PISTON AXIS.**

**Characteristic****Standard clearance:**

0.001 ÷ 0.010 mm

- Measure the outside diameter of the piston, perpendicular to the gudgeon pin axis.
- Take the measurement in the position shown in the figure.

**N.B.**

**REFER TO THE «SPECIFICATIONS» SECTION FOR THE SIZES OF THE PISTON AND THE CYLINDER-PISTON COUPLING CLEARANCES.**

**Characteristic****A:**

10 mm

**Piston diameter:**

94 mm nominal value

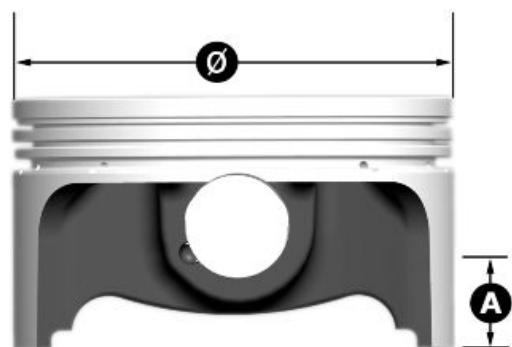

- Using a bore meter, measure the cylinder inner diameter at a given height according to the directions shown in the figure.

### Characteristic

#### B:

43 mm

#### Standard diameter:

94 mm nominal value

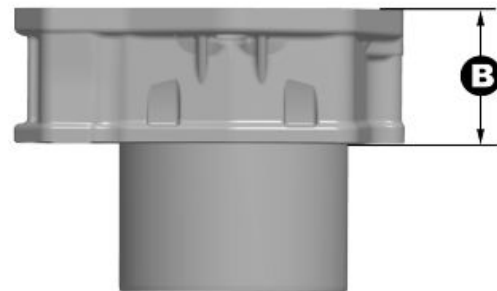
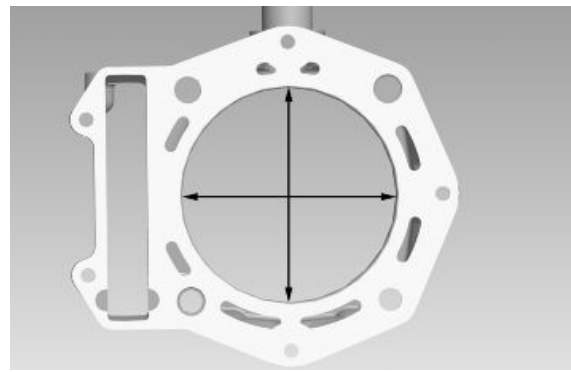

- Check that coating is free from flakes.
- Check that the head matching surface exhibits no deformations or wear.

### Characteristic

#### Maximum allowable run-out:

0.05 mm

- Pistons and cylinders are classified into categories based on their diameter. The coupling is carried out in pairs (A-A, B-B, C-C, D-D).

#### N.B.

**REFER TO THE «SPECIFICATIONS» SECTION FOR THE SIZES OF THE CYLINDER AND THE CYLINDER-PISTON COUPLING CLEARANCES.**

## Inspecting the piston rings

- Alternately insert the three sealing rings into the cylinder, in the area where it retains its original diameter. Using the piston, insert the rings perpendicularly to the cylinder axis.
- Make sure that each single sealing ring evenly adheres to the cylinder liner. If it does not, this means the ring is worn. Replace it.
- Measure the opening (see figure) of the sealing rings using a feeler gauge.



- If higher values than those prescribed are measured, replace the linings.

**Check the size of the sealing ring opening:**

**Compression ring:** 0.15 ÷ 0.35 mm. Max. value 0.5 mm

**Oil scraper ring:** 0.25 ÷ 0.50 mm. Max. value 0.65 mm

**Oil scraper ring:** 0.25 ÷ 0.50 mm. Max. value 0.65 mm

**Rings/housing coupling clearances:**

Carefully clean the sealing ring housings.

Place a thickness gauge between the ring and the housing as shown in the drawing and check the coupling clearances.

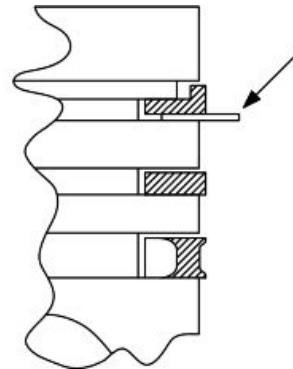

**Top ring Standard coupling clearance:**

0.01÷0.06 mm

**Maximum clearances allowed after use:** 0.10 mm

**Intermediate ring Standard coupling clearance:**

0.02÷0.07 mm

**Maximum clearances allowed after use:** 0.10 mm

**Oil scraper ring Standard coupling clearance:**

0.01÷0.06 mm

**Maximum clearances allowed after use:** 0.10 mm

Replace the piston if clearances exceed the maximum limits specified in the table.

## Removing the piston

- Install piston and wrist pin onto the connecting rod, aligning the piston arrow the arrow facing towards the exhaust.



- Insert the locking ring into the special tool, with the opening in the position indicated on the tool.

S = left

D= right



- Place the wrist pin stop ring into position using a punch



- Install the pin lock using the key shown in the figure.

### Specific tooling

**020470Y Pin retainers installation tool**



**N.B.**

**THE TOOL FOR INSTALLING THE STOP RINGS MUST BE USED MANUALLY.**

**CAUTION**

**USING A HAMMER MIGHT DAMAGE THE STOPS' HOUSING.**

## Choosing the gasket

- Provisionally fit the piston into the cylinder, without any base gasket.
- Install a comparator on the special tool using the short union, as shown in the figure.

### Specific tooling

**020475Y Piston position checking tool**

- Using an abutment plane, reset the comparator with a preload of a few millimetres.
- Finally fix the comparator.
- Check the perfect sliding of the feeler pin.
- Install the tool on the cylinder without changing the comparator position.
- Lock the tool using the original head fixing nuts.
- Rotate the crankshaft until TDC (the inverted point of the dial gauge rotation)
- Measure the deviation from the reset value.



- Identify the thickness of the cylinder base gasket to be used for reassembly by the table below. Correctly identify the cylinder base gasket thickness to keep the correct compression ratio.
- Remove the special tool and the cylinder.

**N.B.**

**IF DEVIATIONS (OR RECESSES OR PROJECTIONS) CLOSE TO THE CHANGE OF CATEGORY ARE MEASURED, REPEAT THE MEASUREMENT AT THE OPPOSED SIDE. TO DO SO, REPEAT THE TOOL INSTALLATION BY INVERTING ITS POSITION.**

### **Characteristic**

#### **Recess / Projection measured 1**

- 0.185 - - 0.10

#### **Gasket thickness 1**

$0.4 \pm 0.05$

#### **Recess / Projection measured 2**

- 0.10 - + 0.10

#### **Gasket thickness 2**

$0.6 \pm 0.05$

#### **Recess / Projection measured 3**

+ 0.10 - + 0.185

#### **Gasket thickness 3**

$0.8 \pm 0.05$



## Refitting the piston rings

- Place the scraper ring spring on the piston.
- Install the scraper ring keeping the opening opposed to the spring junction and with the writing "top" facing the piston top. The chamfered side of the oil scraper ring should always be facing the piston crown.
- Fit the second lining with the identification letter or the writing "top" facing the piston crown. In any case, the step must be facing opposite the piston top.
- Install the first compression lining in the direction imposed by the housing.
- It is advisable to use a fitter to facilitate the installation of the linings.



### N.B.

**THE TWO PISTON RINGS ARE MADE WITH A TAPERED CYLINDRICAL CONTACT CROSS-SECTION. THIS IS TO ACHIEVE A BETTER BEDDING.**

- Misalign the lining openings at 120° as shown in the figure.
- Lubricate the components with engine oil.
- The engine uses the first compression lining with an L section.

## Refitting the cylinder

- Insert the cylinder base gasket with the thickness determined above.
- Using the fork and the band clamp, install the cylinder as shown in the figure.

### N.B.

**BEFORE INSTALLING THE CYLINDER, CAREFULLY BLOW THE LUBRICATION DUCT AND LUBRICATE THE CYLINDER LINER. CHECK THE PRESENCE OF THE TWO REFERENCE DOWELS.**



### Specific tooling

**020468Y** Piston fitting band

**020512Y** Piston fitting fork

## Inspecting the cylinder head

- Using a trued bar and feeler gauge check that the cylinder head surface is not worn or distorted.

**Characteristic****Maximum allowable run-out:**

0.1 mm

- In case of irregularities, replace the head.
- Check the sealing surfaces for the intake and exhaust manifold.
- Check that the camshaft and the rocker pin capacities exhibit no wear.
- Check that the head cover surface is not worn.
- Check that the coolant sealing pad exhibits no oxidation.

**Inspecting the timing system components**

- Check that the guide shoe and the tensioner shoe are not worn out.
- Check that the crankshaft pinion and the camshaft timing gear and crankshaft pinion exhibit no wear.

In case of wear of the sliding blocks, replace them.  
In case of wear of the chain or rim, replace the entire unit.

**N.B.**

**IF THE CHAIN HAS DAMAGED THE PINION, REPLACE THE CRANKSHAFT AS DESCRIBED IN CHAPTER CRANKCASE AND CRANKSHAFT.**

**Chain tensioner:**

- Remove the centre screw with the washer and the tensioner spring. Check that the one-way mechanism is not worn.
- Check the condition of the tensioner spring.
- If examples of wear are found, replace the whole assembly.

**Inspecting the valve sealings**

- Visually inspect the valve sealing surface.

**CAUTION**

**DO NOT REVERSE THE FITTING POSITIONS OF THE VALVES (RIGHT - LEFT).**

- If the sealing surface of the valve is found to be interrupted at one or more points or is not flat, replace the valve.

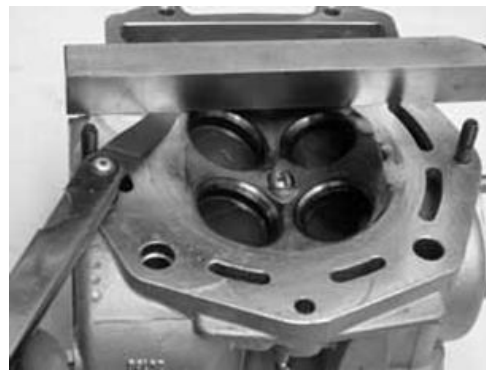

- Insert the valves into the cylinder head.
- Alternatively check the intake and exhaust valves.
- The test is carried out by filling the manifold with petrol and checking that the head does not ooze through the valves when these are just pressed with the fingers.



### Inspecting the valve housings

- Clean the valve seats of any carbon residues.
- Using the Prussian blue, check the width of the impression on the valve seat "V".

**Characteristic**

**Standard value:**

1 - 1.3 mm

**Admissible limit:**

1.6 mm

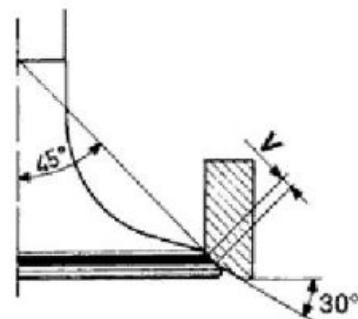

- If the impression width on the valve seat is larger than the prescribed limits, true the seats with a 45° mill and then grind.
- In case of excessive wear or damages, replace the head.

### Inspecting the valves

- Measure the diameter of the valve stems in the three positions indicated in the diagram.

**STANDARD DIAMETER**

Specification	Desc./Quantity
Inlet:	4.987 - 4.972 mm
Outlet:	4.975 - 4.960 mm

**MINIMUM ADMISSIBLE DIAMETER**

Specification	Desc./Quantity
Inlet:	4.96 mm
Outlet:	4.945 mm

- Calculate the clearance between valve and valve guide.

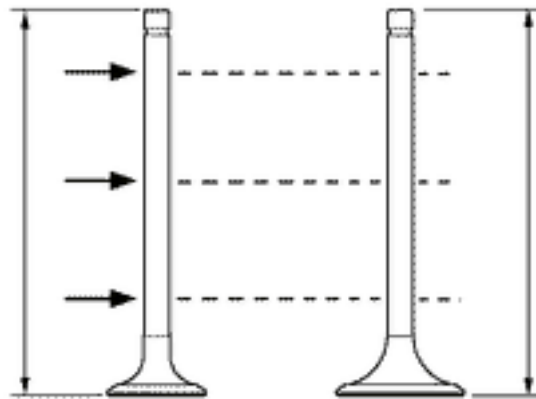

- Check the deviation of the valve stem by resting it on a "V" shaped abutment and measuring the extent of the deformation by a comparator.

**Characteristic**  
**Limit values admitted:**  
 0.1 mm

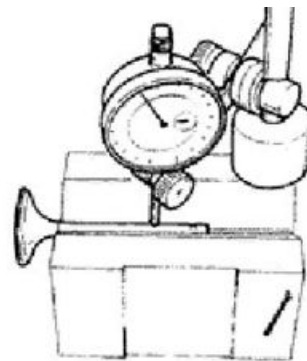

- Check the concentricity of the valve head by arranging a comparator at right angle relative to the valve head and rotate it on a "V" shaped abutment.

**Characteristic**  
**Admissible limit:**  
 0.03 mm

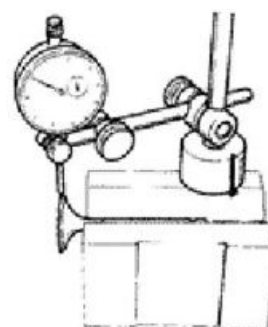

**Inspecting the valve stem guide clearance**

- After measuring the valve guide diameter and the valve stem diameter, check the clearance between guide and stem.

**INLET**

Specification	Desc./Quantity
Standard clearance:	0.013 - 0.04 mm
Admissible limit:	0.08 mm

**OUTLET**

Specification	Desc./Quantity
Standard clearance:	0.025 ÷ 0.052 mm
Admissible limit:	0.09 mm

**STANDARD VALVE LENGTH**

Specification	Desc./Quantity
Inlet:	95.0 ± 0.3 mm
Outlet:	94.2 ± 0.3 mm

- Check that there are no signs of wear on the surface of contact with the articulated register terminal.

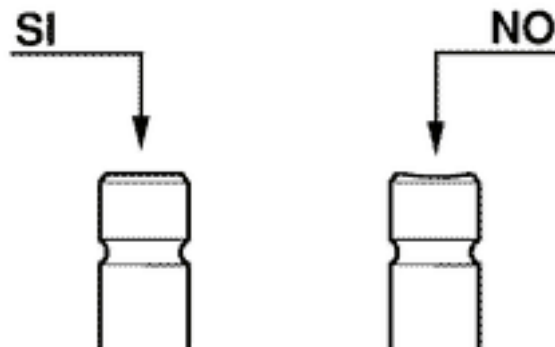

- If the checks above give no failures, you can use the same valves. To obtain better sealing performance, grind the valve seats. Grind the valves gently with a fine-grained lapping compound. During the grinding, keep the cylinder head with the valve axes in a horizontal position. This will prevent the lapping compound residues from penetrating between the valve stem and the guide (see figure).



**CAUTION**

**TO AVOID SCORING THE CONTACT SURFACE, DO NOT KEEP ROTATING THE VALVE WHEN NO LAPPING COMPOUND IS LEFT. CAREFULLY WASH THE CYLINDER HEAD AND THE VALVES WITH A SUITABLE PRODUCT FOR THE TYPE OF LAPPING COMPOUND BEING USED.**

**CAUTION**

**DO NOT REVERSE THE FITTING POSITIONS OF THE VALVES (RIGHT - LEFT).**

## Inspecting the springs and half-cones

- Check that the upper and lower supporting spring washers, the cotters and the oil seal show no sign of abnormal wear. Replace a component when worn.



- Measure the free length of the spring.

**Characteristic**

**Standard length:**

44.4 mm

**Admissible limit after use:**

42.4 mm



## Refitting the valves

- Place the valve spring support washers on the head.
- Alternately insert the 4 oil guards using the special tool.
- Lubricate the oil guards and the valve guides.

**Specific tooling**

**020306Y Punch for assembling valve seal rings**



- Fit the valves, the springs and the spring retaining washers. Using the appropriate tool with adapter, compress the springs and insert the cotters in their seats.



**Specific tooling**

**020382Y Valve cotters equipped with part 012 removal tool**

**020382Y012 bush (valve removing tool)**

**N.B.**

**DO NOT CHANGE THE VALVE FITTING POSITION. FIT THE VALVE SPRINGS WITH THE REFERENCE COLOUR ON COTTER SIDE (TURNS WITH GREATER PITCH).**

**Inspecting the cam shaft**

- Check that the camshaft ends exhibit no scratches or irregular wear.
- Using a micrometer, measure the camshaft capacity.

**STANDARD DIAMETER**

Specification	Desc./Quantity
Bearing A Ø:	42 - 0.060 -0.085 mm
Bearing B diameter:	20 - 0.020 -0.041 mm

**MINIMUM ADMISSIBLE DIAMETER**

Specification	Desc./Quantity
Bearing A Ø:	41.910 mm
Bearing B diameter:	19.940 mm

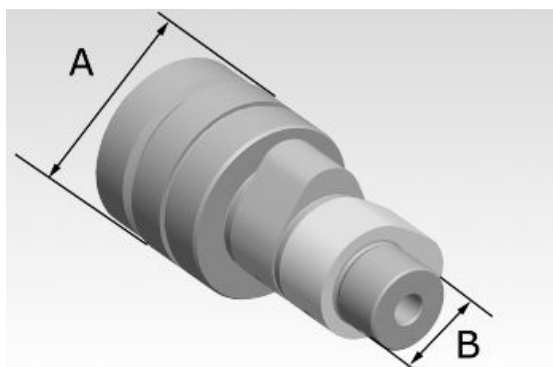

-Using a gauge, measure the cam height.

**STANDARD HEIGHT**

Specification	Desc./Quantity
intake	33.774 mm
discharge	33.273

**ADMISSIBLE LIMITS**

Specification	Desc./Quantity
intake	33.526 mm

Specification	Desc./Quantity
discharge	33.026 mm
Standard axial clearance:	0 - 0.22 mm
Maximum admissible axial clearance:	0.3 mm

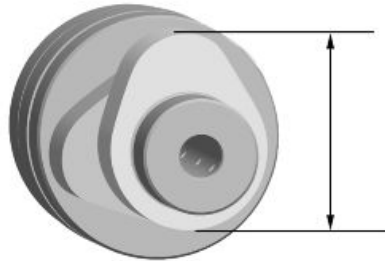

- If any of the above dimensions are outside the specified limits, or there are signs of excessive wear, replace the defective components with new ones.
- Check that the retaining plate seat shown in the figure exhibits no wear.

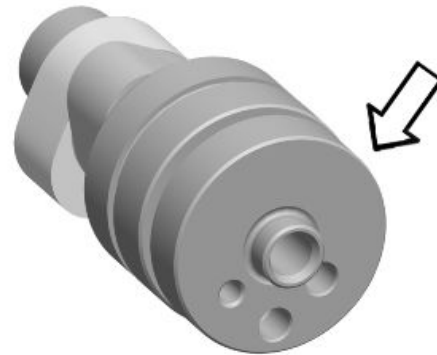

- Check that the automatic valve lifting device cam, the travel end roller and the rubber abutment on the containment bell are free from wear.
- Check that the valve lifting spring has not yielded.
- Replace any defective or worn components.



- Check that the rocking lever pins exhibit no scratches or wear.

### Characteristic

#### Standard diameter:

13 - 0.010 -0.018 mm



- Measure the inside diameter of each rocking lever.

**Characteristic****Standard diameter:**

13 + 0.026 +0.015 mm



- Check that the cam contact sliding block and the articulated register plate is free from wear.
- In case of wear, replace the component.

**Refitting the head and timing system components**

- Insert the chain guide sliding block.
- Insert the two centring dowels between head and cylinder.
- Install the head gasket.

**N.B.**

**THE FIGURE SHOWS THE INSERTION POSITION OF THE TWO CENTRING DOWELS BETWEEN HEAD AND CYLINDER. THE DIRECTION OF INSTALLATION FOR THE GASKET IS FORCED BY THE DOWELS.**

- The head gasket is made of steel and has a standard thickness.



- Check that the head lubrication channel is perfectly clean. Clean with compressed air jets, if required.
- Insert the head.
- Lubricate the stud bolts and the 4 fastening columns.

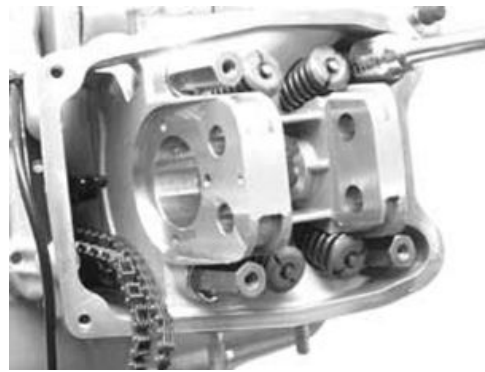

- Tighten the 4 fastening columns crosswise to the prescribed torque as shown in the figure.

**Locking torques (N\*m)**

**Head fixing stud bolts: \*\*\***

- \*\*\* Apply a preliminary torque of 7 Nm in a crossed sequence.
- Tighten by 90° in a crossed sequence.
- Tighten again by 90° in a crossed sequence.

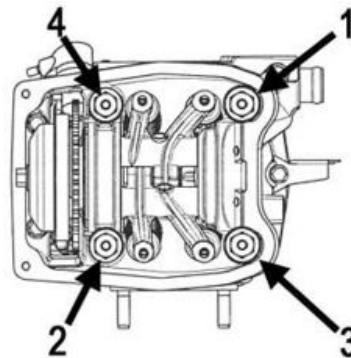

- Tighten the fastening nuts on the exhaust and on the intake side to the prescribed torque.

**Locking torques (N\*m)**

**Exhaust / intake head fixing nuts: 10 - 12**

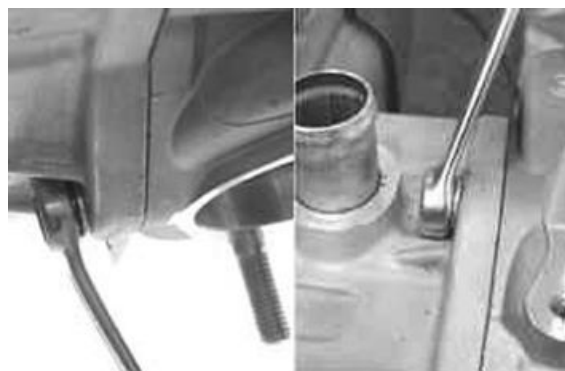

- Tighten the 3 side screws to the prescribed torque.

**Locking torques (N\*m)**

**Head fixing screws 10 - 12**

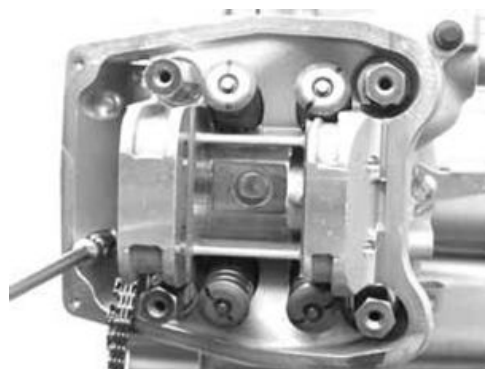

- Install the coolant temperature sensor with the washer and tighten to the prescribed torque.

**CAUTION**

**FAILURE TO OBSERVE THE TIGHTENING TORQUE CAN DAMAGE THE SENSOR.**

**Locking torques (N\*m)**

**coolant temperature sensor: 10 - 12**



- Fit the spark plugs and tighten them to the prescribed torque.

**Locking torques (N\*m)**

**Spark plug 12 ÷ 14 Nm**

- Insert the timing control belt on the crankshaft according to the initial direction of rotation.
- Install the tensioner shoe with its spacer, tightening the bolt to the prescribed torque, using the recommended product.

**Recommended products**

**Loctite 243 Medium strength threadlock**

Medium Loctite 243 threadlock

**Locking torques (N\*m)**

**Tensioner sliding block fixing screw: 10 - 14**

- Insert pins and rocking levers on the flywheel side.
- Lubricate the two rocking levers through the holes at the top.



- Clean the camshaft by blowing with little compressed air jets, especially the retaining plate housing.
- Lubricate the 2 shafts.
- Insert the camshaft into the head with the cams opposite the rocking levers.



- Remove any LOCTITE residues from the screws fixing the camshaft retaining bracket using a brush.
- Apply the recommended product to the fixing screws and tighten to the prescribed torque.

### Recommended products

#### Loctite 243 Medium strength threadlock

Medium Loctite 243 threadlock

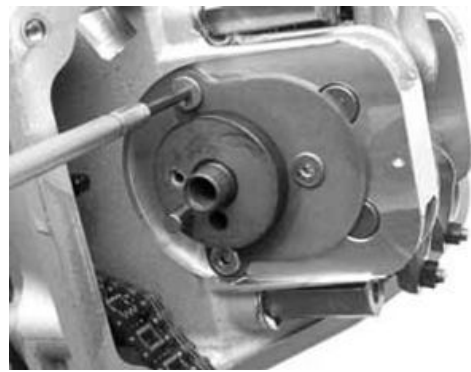

- Insert the camshaft retain bracket with visible countersinks and tighten the 3 fastening screws to the prescribed torque, being careful not to damage the inside hexagon.

### Locking torques (N\*m)

#### Camshaft retaining bracket fastening screws: 4 ÷ 6

- Install the intermediate gear with torque limiter, the flywheel and its cover, as described in Chapter "Flywheel and start-up system", and in Chapter "Flywheel cover".

**N.B.**

**FOR MORE CONVENIENCE, INSTALL THE FLYWHEEL COVER WITHOUT THE COOLING SYSTEM SLEEVES.**

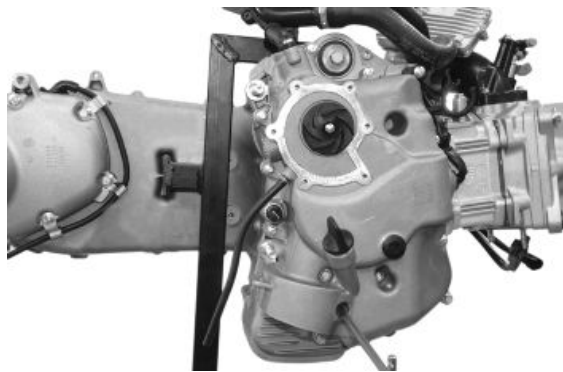

- Using the TORX wrench, remove the timing check cap



- Insert the belt on the camshaft control timing rim.
- Insert the timing rim on the camshaft checking that the references are aligned.

**N.B.**

**DURING THE STROKE CHECK, KEEP THE BELT TENSIONED BY PRESSING ON THE TIGHTENER COMPARTMENT SIDE.**



- 
- Keeping the belt slightly pulled, turn the crankshaft using the driving pulley to make the reference on the magnet support collimate with that on the flywheel cover.



- 
- Install the counterweight mass.
  - Centre using the bell fastening screw.
  - Lock the mass fixing screws to the prescribed torque, using the recommended product.

**Recommended products****Loctite 243 Medium strength threadlock**

Medium Loctite 243 threadlock

**Locking torques (N\*m)****Counterweight screw 7 ÷ 8.5 Nm**

- 
- Remove the central screw.
  - Install the valve lifting mass being careful to the proper positioning of the travel end ring.
  - Lubricate the mass and de-compressor control pin.

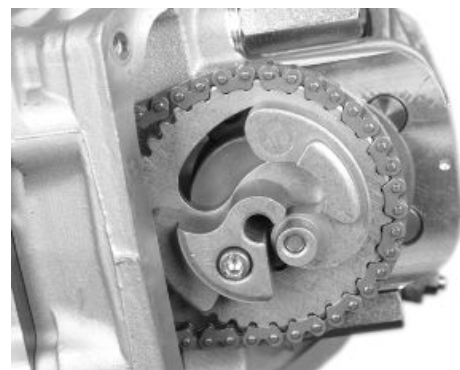
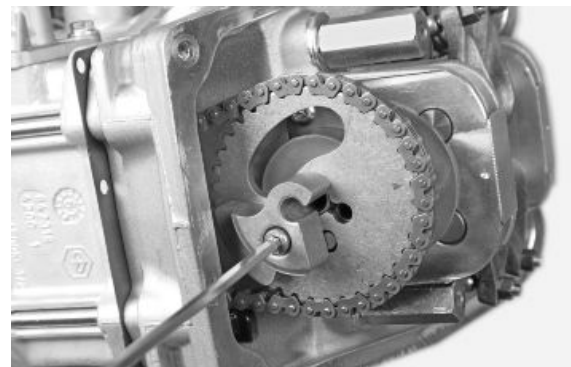

- 
- Install the return spring and load it by about 3/4 turn.



- 
- Turn the engine to move the references to the top as shown in the figure (intake end).

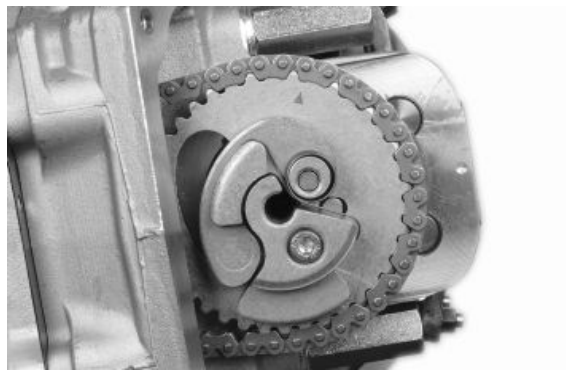

- Insert the valve lifting device mass stop bell.
- Tighten the retaining screw to the prescribed torque, using the recommended product.

**N.B.**

**THE BELL TIMING IS ENSURED BY THE COUNTERWEIGHT MASS FASTENING SCREW HEAD.**

### **Recommended products**

#### **Loctite 243 Medium strength threadlock**

Medium Loctite 243 threadlock

- 
- Check that the decompression mass is free and that it is pulled by the spring.

### **Locking torques (N\*m)**

**Valve lifter mass stop bell fixing screws: 30 - 35**

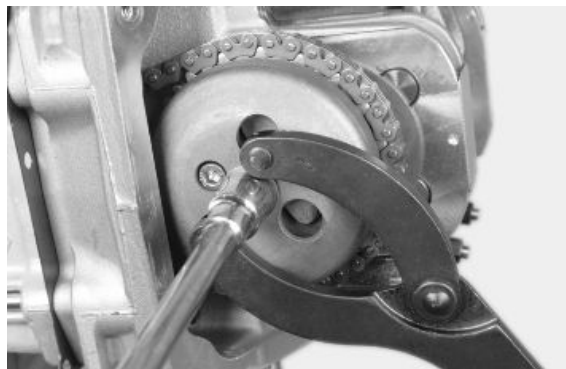

- 
- Place the tightener cursor in the rest position, keeping the retain tab pressed.



- Install a new tightener on the cylinder using a new gasket.
- Tighten the two fastening screws to the prescribed torque.

### Locking torques (N\*m)

Tightener fastening screws: 11 ÷ 13



- Insert the spring with the central screw and the washer.
- Tighten the central screw to the prescribed torque.

### Locking torques (N\*m)

Tightener screw: 5 - 6



- Place the engine with the valve clearance adjustment timing references aligned with the head.
- Check the clearance between valve and rocking lever using a thickness gauge.

### PRESCRIBED CLEARANCE

Specification	Desc./Quantity
Inlet	0.15 mm (engine cold)
drainage	0.15 mm (engine cold)

- In case different values are found, adjust by loosening the lock nut and use a screwdriver for the set screw as shown in the figure.



## Refitting the timing chain

The ignition advance is determined electronically on the basis of parameters known by the control unit. For this reason it is not possible to declare the reference values based on the engine rpm.

The ignition timing value is detectable any time using the diagnostic tester.

It is possible to check whether the ignition advance determined by the system does in fact correspond with the value actually activated on the engine, by means of the stroboscopic light.

### Specific tooling

**020460Y Scooter diagnosis and tester****020330Y Stroboscopic light for timing control**

Proceed as follows:

- Remove the outside transmission cover as described in the automatic transmission chapter.



- Remove the TDC reference inspection cap between flywheel and crankcase cover. See the flywheel cover chapter.



- By the driving pulley, turn the engine to find the alignment of the references to identify the TDC.



- Repeat for the reference between driving pulley and transmission housing.





- Replace the inspection cap on the flywheel side.
- Connect the diagnostic tester.
- Start the engine.
- Select the menu on the "parameter" function.
- Select the stroboscopic light command in the traditional four-stroke engine position (1 spark 2 revs).
- Check that the real values of rpm and ignition advance match those measured using the diagnostic tester.

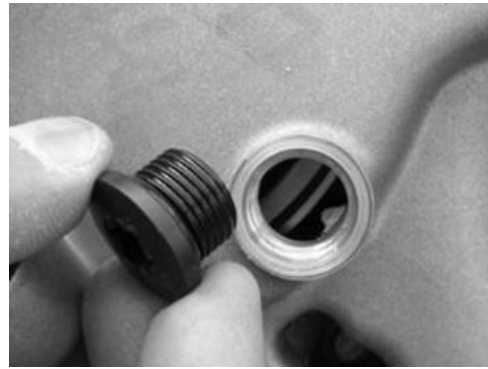

### Specific tooling

#### 020460Y Scooter diagnosis and tester

#### If the values do not match, check:

- distribution timing
- revolution-timing sensor
- Injection control unit

## Refitting the rocker-arms cover

- Check that the gasket is in good working order.



- Tighten the two screws indicated in the figure with "1" and "2" to limit the reciprocal sliding of the cover surface with the head surface.
- Tighten the remaining 4 screws in a crossed sequence (3, 4, 5, 6).

N.B.

**CHECK THE PROPER POSITION OF THE GASKET.**

### Locking torques (N\*m)

Tappet cover fixing screws: 7 - 9

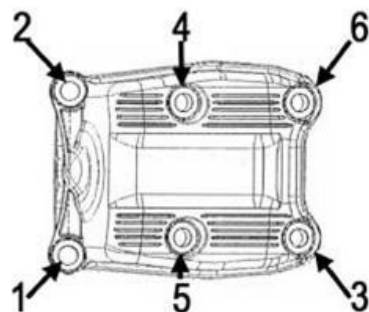

- Install the transmission cover and the relevant net filter and the outside transmission cover as described in the "Automatic transmission" chapter.



- Install the cooling system sleeves using new bands, as described in the "Flywheel cover" chapter.

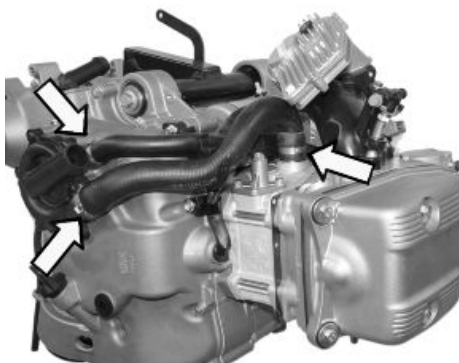

## Refitting the intake manifold

- Install the intake manifold on the engine.
- Insert the 3 fastening screws, one of which with a support band for the cooling system sleeve, and tighten to the prescribed torque.

### Locking torques (N\*m)

**Inlet manifold screws 11 ÷ 13**



## Crankcase - crankshaft

- Remove the outside and inside transmission cover and the complete driving pulley as described in "Automatic transmission".
  - Remove the flywheel cover with the cooling system sleeves, as described in the "Flywheel cover" chapter.
  - Remove the flywheel with the starting system following the instruction given in "Flywheel and Starting system".
  - Remove the thermal unit (cylinder, head, piston) as described in the Thermal unit and timing system chapter.
  - Before opening the crankcase, check the crankshaft axial clearance.
- For this purpose, use a plate (e.g. the special tool) and a support with special tool comparator.

**Specific tooling**

020262Y Crankcase splitting strip

020335Y Magnetic support for dial gauge

**Characteristic****Standard clearance:**

0.10 - 0.50 mm

**Admissible increase limit after use:**

0.60 mm

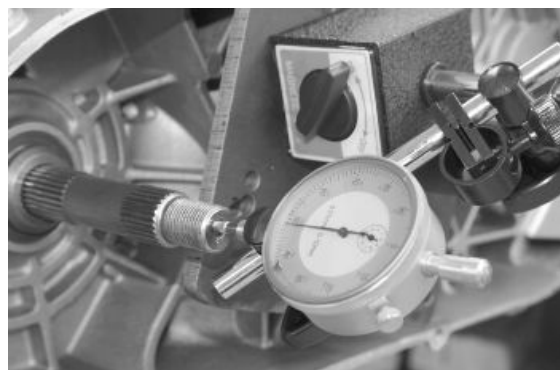

- Upper clearances are an indication of wear on the surfaces of the crankshaft casing support.
- To carry out an accurate measurement, measure the clearance in both directions between crankcase and crankshaft.

**Splitting the crankcase halves**

- Remove the engine support retain screw on the flywheel side half-crankcase.



- Remove the 14 crankcase coupling screws.

**N.B.**

**THE FASTENING SCREWS ARE OF 3 DIFFERENT LENGTHS. NOTE THEIR CORRECT POSITION.**



- Split the crankcases while keeping the crankshaft inserted on the flywheel side half-crankcase.
- Remove the coupling gasket.

**N.B.**

**THE BUSHING SUPPORT CAN BE LEFT IN THE FLYWHEEL SIDE HALF-CRANKCASE.**

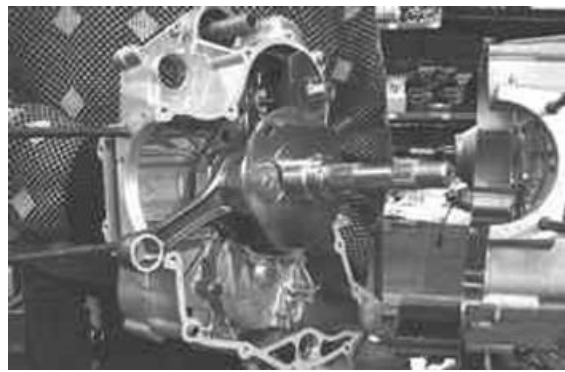

## Removing the crankshaft

- Before removing the crankshaft, check the timing with the countershaft. To carry out this check, turn the crankshaft to align the two holes obtained on the crankshaft with the hole on the countershaft control gear.

This is an optimal position also to remove the crankshaft.



- Remove the crankshaft with the shim adjustment washer on the flywheel side.

**CAUTION**

**WHILE OPENING THE CRANKCASE AND REMOVING THE CRANKSHAFT, CHECK THAT THE SHAFT THREADED ENDS DO NOT INTERFERE WITH THE MAIN BEARINGS. FAILURE TO OBSERVE THIS PRECAUTION CAN DAMAGE THE MAIN BEARING.**



## Removing the oil pump and countershaft control gear.

- To remove the control gear, loosen the 4 fastening screws.

**Remove the gear only if actually required.**

**CAUTION**

**THE SCREWS HAVE A COUNTERSUNK HEAD AND THEIR THREADING IS LOCKED BY LOC-TITE. BE CAREFUL NOT TO DAMAGE THE CONTROL HEXAGON. TO OBTAIN BETTER RESULTS IT IS PREFERABLE TO USE AN INSIDE HEXAGON SOCKET WRENCH.**



---

## Removing the countershaft

- Place the special tool as shown in the figure.

### Specific tooling

**020479Y Countershaft lock wrench**



- Remove the fastening nut with relevant washer.



- Remove the special tool and extract the countershaft with the control gear.



---

## Replacing the countershaft bearings

- Check that the bearings are free from irregular noise or clearance. If it is, replace it.

### Flywheel-side half-crankcase

- Remove the inside seeger ring.



- Upturn the half-crankcase.
- Remove the bearing from the flywheel side half-crankcase using the special tool and a mallet.

### Specific tooling

**020376Y Adaptor handle**

**020358Y 37x40 mm adaptor**

**020439Y 17 mm guide**



- Remove the bearing from the transmission side half-crankcase using the special tool.

### Specific tooling

**001467Y008 Extraction pliers for  $\varnothing$  17 mm bearings**

**001467Y007 Driver for OD 54 mm bearing**



- Before installing a new bearing, heat the flywheel side half-crankcase using the special tool.
- Place the half-crankcase on a wooden base.

### Specific tooling

**020151Y Air heater**



- Insert a new bearing on the special tool after greasing the guide seat.
- Install the new bearing on the half-crankcase using the special tool.

**N.B.**

**IF A BEARING WITH PLASTIC CAGE IS USED, KEEP THE BALLS VISIBLE FROM THE CRANKCASE INTERNAL SIDE.**

### Specific tooling

**020376Y Adaptor handle**

**020359Y 42 x 47 mm adaptor**

**020439Y 17 mm guide**



- 
- Fit the seeger ring.



- 
- Before installing the new bearing on the transmission side crankcase, heat the seat using the special tool.

**Specific tooling****020151Y Air heater**

- 
- Insert a new bearing on the special tool after greasing the guide seat.
  - Install the new bearing on the engine crankcase using the special tool.

**N.B.****IF A BEARING WITH PLASTIC CAGE IS USED,  
KEEP THE BALLS VISIBLE FROM THE  
CRANKCASE INTERNAL SIDE.****Specific tooling****020376Y Adaptor handle****020359Y 42 x 47 mm adaptor****020439Y 17 mm guide**

## Inspecting the crankshaft components

- Check the axial clearance on the connecting rod.

### Characteristic

#### Standard clearance:

0.20 ÷ 0.40 mm



- Check the connecting rod diametrical clearance.

### Characteristic

#### Standard clearance:

0.046 ÷ 0.076 mm

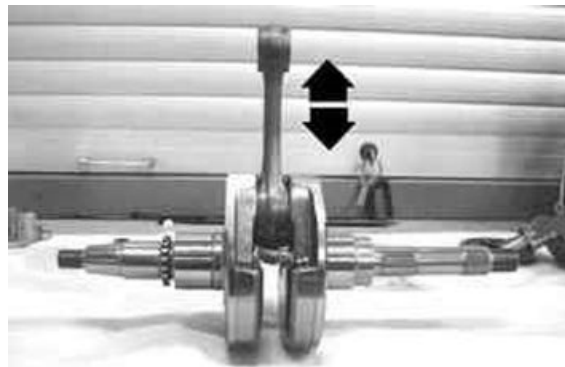

- Check the surfaces that limit the axial free-play are not scored and measure the width of the crankshaft between these surfaces, as shown in the diagram.

**N.B.**

**BE CAREFUL NOT TO LET THE MEASUREMENT BE AFFECTED BY THE UNIONS WITH THE CRANKSHAFT ENDS.**

### Characteristic

#### Standard dimensions:

63.6 - 63.45 mm

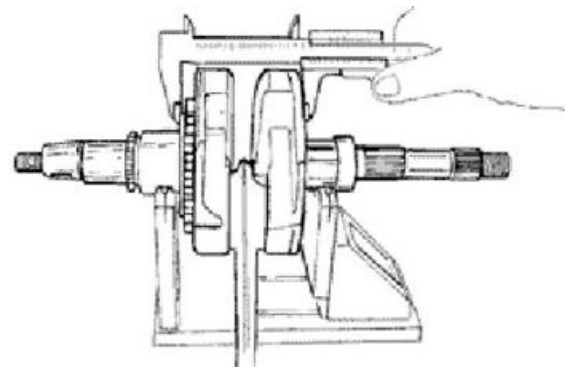

### CAUTION

**THE CRANKSHAFT CAN BE REUSED WHEN THE WIDTH FALLS WITHIN THE STANDARD VALUES AND THE SURFACES ARE FREE FROM SCRATCHES.**

### Shimming

- Check the overall height of the crankshaft - shoulders - gear assembly.

### Characteristic

#### Standard thickness:

71.804 - 72.000 mm

- Check that shim adjustment is free from scratches.

**N.B.**

**IN CASE OF NEW UTILISATION, MAINTAIN THE FIRST FITTING POSITION.**



**Specific tooling**

**020074Y Support base for checking crankshaft alignment**

- If the crankshaft - crankcase axial clearance is higher than the standard value and the crankshaft exhibits no irregularity, the problem is caused by wear or by a wrong machining on the engine crankcase.

- Check the diameters of both the bearings of the crankshaft in accordance with the axes and surfaces shown in the figure. Half-shafts are classified into two categories, Cat. 1 and Cat. 2.

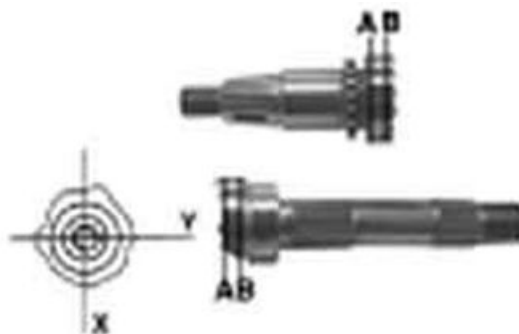

**STANDARD DIAMETER**

Specification	Desc./Quantity
Cat. 1	40.010 ÷ 40.016
Cat. 2	40.016 ÷ 40.022

**Inspecting the crankshaft alignment**

- Install the crankshaft on the support and measure the displacement at the 4 points shown in the figure.

**Specific tooling**

**020074Y Support base for checking crankshaft alignment**

**MAX ADMISSIBLE DISPLACEMENT:**

Specification	Desc./Quantity
A	= 0.15 mm
B	= 0.01 mm
C	= 0.01 mm
D	= 0.10 mm

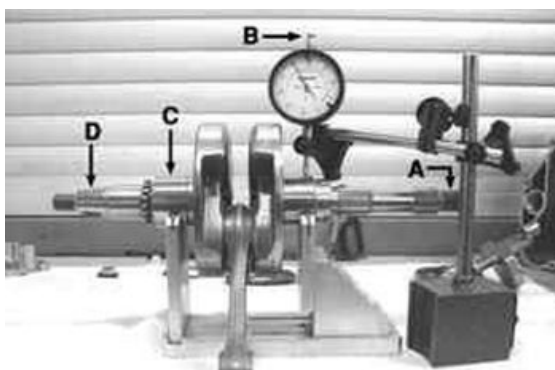

- Check that the driving shaft cone, the tab seat, the oil seal capacity, the toothed gear and the threaded tangs are in good working order.

- In case of failures, replace the crankshaft.

**N.B.**

**MAIN BEARINGS CANNOT BE MODIFIED.**

The connecting rod cannot be replaced. To check the connecting rod small end diameter, see chapter "Thermal unit and timing system".

- When cleaning the crankshaft, be careful to prevent any impurity from entering into the shaft lubrication hole.

**N.B.**

IN CASE OF REPLACEMENT OF A CRANKSHAFT CONSISTING OF TWO HALF-SHAFTS OF DIFFERENT CATEGORY, REPLACE THE TWO HALF-CRANKCASES AS WELL, COUPLING THE TWO COMPONENTS (SHAFT AND CRANKCASE) WITH THE SAME CATEGORY.

- To check the gearing of the crankshaft, see section "Thermal unit and timing system".



**See also**

[Cylinder assy. and timing system](#)

## Inspecting the crankcase halves

- Before proceeding to check the crankcase halves, thoroughly clean the all surfaces and oil ducts.

- For the transmission-side half-crankcase, special attention should be given to the bushings, to the cooling jet on the transmission side (see figure) and to the lubrication duct.



**N.B.**

**THE JET IS FED THROUGH THE MAIN BUSHINGS. PROPER OPERATION OF THIS COMPONENT IMPROVES THE PISTON TOP COOLING. CLOGGING HAS EFFECTS THAT ARE DIFFICULT TO DETECT (PISTON TEMPERATURE INCREASE). FAILURE OR LEAK CAN CONSIDERABLY DECREASE THE MAIN BUSHING AND CONNECTING ROD LUBRICATION PRESSURE.**

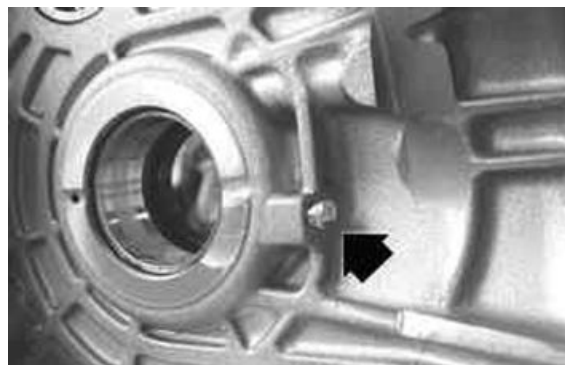

- For the flywheel side half-crankcase, special attention should be given to the lubrication channels for the main bearings and to the compartment and the channels for the oil pump, as well as to the duct for the by-pass located on the flywheel cover.

**N.B.**

**AS ALREADY DESCRIBED IN THE "LUBRICATION" CHAPTER, IT IS ESPECIALLY IMPORTANT THAT THE BY-PASS HOUSING ON THE FLYWHEEL COVER IS FREE FROM WEAR THAT MAY IMPAIR THE PROPER SEALING OF THE LUBRICATION PRESSURE ADJUSTMENT PISTON. THE HEAD LUBRICATION CHANNEL IS PROVIDED WITH A SHUTTER JET; THIS GIVES A "LOW PRESSURE" HEAD LUBRICATION. THIS CHOICE WAS MADE TO REDUCE THE OIL TEMPERATURE IN THE SUMP.**

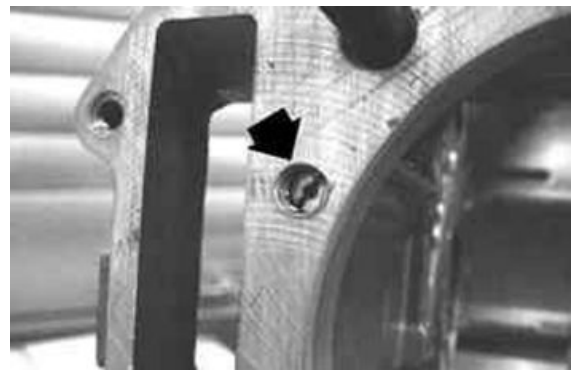

The jet clogging impairs the head lubrication and the timing mechanisms.

A jet failure causes a decrease of the main bearing and connecting rod lubrication pressure.

- Check that the surfaces are free from dents or deformations, with special attention to the crankcase coupling and the crankcase-cylinder surfaces.
- Any defects in the crankcase gasket or matching surfaces (see Flywheel cover coupling) can cause pressurised oil leaks, thereby affecting the connecting rod and main bearing lubrication pressure.
- Check the main bearing seats that limit axial clearance in the crankshaft show no signs of wear. For the dimensional check, refer to the instructions relating to the axial clearance and dimensions check on the crankshaft

## Inspecting the crankshaft plain bearings

- To obtain a good bushing lubrication it is necessary to have both an optimal lubricating pressure (4 bar) and a good oil flow rate; the bushings must be correctly positioned so as not to obstruct the oil supply channels.

- The main bushings are comprised of two half-bearings, one containing holes and channels for lubrication and the other solid.

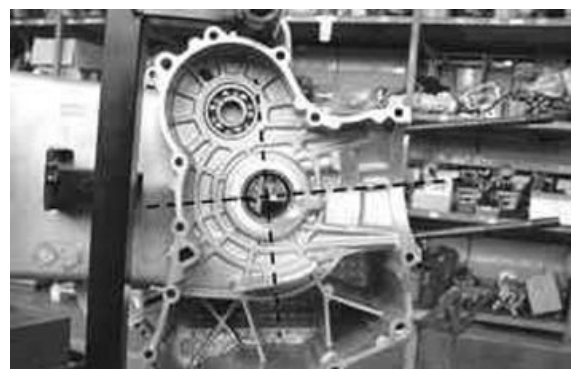

- The solid half-bearing is intended to stand the thrusts caused by combustion, and for this reason it is arranged opposed the cylinder.
- To prevent shutters in the oil feeding channels, the matching surface of the two half-bearings must be perfectly orthogonal to the cylinder axis, as shown in the figure.

- The oil supply channel section is also affected by the bushings driving depth compared with the crankshaft axial clearance of the limiting surface.

**N.B.**

**TO KEEP SUCH POSITION OF THE BUSHINGS ON THE CRANKCASE, DRIVING IS FORCED ON CAST-IRON RINGS INSERTED IN THE CASTING OF BOTH HALF-CRANKCASES.**

- Check the inside diameter of the main bushings in the three directions indicated in the diagram.
- Repeat the measurements for the other bushing half. see diagram.

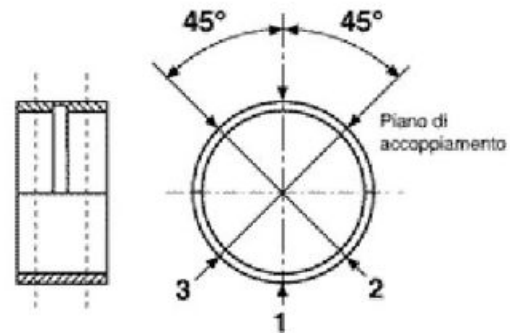

**N.B.**

**DO NOT TAKE THE MEASUREMENT ON THE TWO HALF-SHELL COUPLING SURFACE SINCE THE ENDS ARE RELIEVED TO ALLOW BENDING DURING THE DRIVING OPERATION.**

Before assembling, check that the clearance between the engine crankcase bushing and the crankshaft is within the predetermined limits.

**Characteristic**

**Crankshaft-bushing maximum clearance admitted:**

0.08 mm

- The standard bushing diameter after driving is variable on the basis of a coupling selection.
- The crankcase bushing seats are classified into 3 categories while the crankshaft ones, into 2 categories.
- Bushings are subdivided into 4 categories according to their thickness (see the table).

**CHECK THE BENCH BUSH**

Name	Description	Dimensions	Initials	Quantity
Type A - Red		1.971 ÷ 1.974		
Type B - Blue		1.974 ÷ 1.977		
Type C - Yellow		1.977 ÷ 1.980		
Type D - Green		1.980 ÷ 1.983		

**Coupling chart**

The following kinds of bushings indicated in the table must be used according to the kind of coupling between the crankshaft and the crankcase.

		<b>X</b>	
		<b>1</b>	<b>2</b>
<b>Y</b>	<b>1</b>	<b>B</b>	<b>A</b>
	<b>2</b>	<b>C</b>	<b>B</b>
	<b>3</b>	<b>D</b>	<b>C</b>

**KEY**

**X** = Crankshaft category

**Y** = Crankcase half-shell category

**A** = Red

**B** = Blue

**C** = Yellow

**D** = Green

In case of breakdown, crankcases are together with bushings and are classified according to the centre to centre distance of the countershaft. Find below the possible couplings.

- Complete FC1 type crankcase equipped with bushings for housing a category 1 crankshaft and a countershaft with centre to centre distance A.
- Complete FC2 type crankcase equipped with bushings for housing a category 2 crankshaft and a countershaft with centre to centre distance A.
- Complete FC3 type crankcase equipped with bushings for housing a category 1 crankshaft and a countershaft with centre to centre distance B.
- Complete FC4 type crankcase equipped with bushings for housing a category 2 crankshaft and a countershaft with centre to centre distance B.

**N.B.**

**THE CRANKSHAFT CATEGORY IS STAMPED ON THE COUNTERWEIGHT SHOULDER.**

A spare crankcase cannot be combined with a driving shaft with mixed categories. Spare shafts have half-shafts of the same category.

**N.B.**

**TO REPLACE THE HALF-SHAFTS, REMOVE THE COUNTERSHAFT BEARINGS AS DESCRIBED ABOVE. REMOVE THE COMPLETE DRIVEN PULLEY AND THE ANTI-FLAPPING ROLLER FROM**

THE TRANSMISSION SIDE HALF-CRANKCASE, AS DESCRIBED IN CHAPTER "AUTOMATIC TRANSMISSION", AND THE HUB COVER WITH THE RELEVANT GEARS AND BEARINGS AS DESCRIBED IN CHAPTER "FINAL REDUCTION".

## Countershaft

- Using a micrometer, measure the 2 bearings of the countershaft as shown in the figure.



### Characteristic

#### Standard diameter:

17 - 0.01 - 0.02 mm

- Check that the water pump drive is not worn.

## Refitting the crankshaft

- Check that the oil pump and countershaft control gear are free from deformations or dents. Replace, if required.

### N.B.

**IF YOU HAVE TO REPLACE THE OIL PUMP AND COUNTERSHAFT CONTROL GEAR IT IS NECESSARY TO REPLACE THE COUNTERSHAFT GEAR AS WELL.**

- Before installing the gear on the crankshaft, carefully clean the two matching surfaces removing any residues of LOCTITE from the holes using a brush.



Blow with compressed air and degrease the mounting holes on both surfaces to make the new LOCTITE grip.

Apply the recommended product to the holes again.

### Recommended products

#### Loctite 243 Medium strength threadlock

Medium Loctite 243 threadlock

- Repeat the same procedure for the 4 fastening screws.
- Insert the control gear on the crankshaft with the hole countersink visible.
- Tighten the 4 fastening screws to the prescribed torque.

### N.B.

**TO AVOID DAMAGING THE SCREW CONTROL HEXAGON, IT IS PREFERABLE TO USE AN INSIDE HEXAGON SOCKET WRENCH.**

### Locking torques (N\*m)

#### Gear mounting on crankshaft screws 10 -12

- Lubricate the main bearing on the flywheel side half-crankcase.
- Lubricate the shim adjustment washer.
- Insert the shim adjustment washer on the crankshaft in its original position.
- Insert the special timing tool in the hole on the countershaft.



### Specific tooling

#### 020471Y Pin for countershaft timing

- Insert the crankshaft on the pin and into the bushing.
- Before inserting thoroughly, make the oil pump gear align with the control gear.
- Insert thoroughly and remove the special tool.



**N.B.**

**WHEN INSERTING THE SHAFT ON THE HALF-CRANKCASE, BE CAREFUL NOT TO DAMAGE THE MAIN BEARING WITH THE THREADED TANG OF THE CRANKSHAFT AND WITH THE TIMING CONTROL TOOTHED PINION.**

- Install the oil pump closing plate.
- Tighten the 2 flanged fastening screws to the prescribed torque.



### Locking torques (N\*m)

#### Bulkhead screws for oil pump housing cover 8 - 10

## Refitting the crankcase halves

- Remove the oil guard from the transmission side half-crankcase using a screwdriver.



- Install a new oil guard after lubricating it, using the special tool, arranging it at a 0.5 mm recess from the crankcase plane.

### CAUTION

**A WRONG POSITIONING OF THE OIL GUARD AFFECTS THE LUBRICATION OIL CIRCULATION.**

### Specific tooling

**020360Y 52 x 55 mm adaptor**

**020376Y Adaptor handle**



- Insert the gasket on the flywheel side half-crankcase.



- Lubricate the main bearing on the transmission side half-crankcase.

**- Couple the 2 half-crankcases being careful not to damage the bushing on the transmission side half-crankcase with the threaded tang of the crankshaft.**

- Insert the engine support retain screw on the flywheel side half-crankcase without tightening.





- Insert the 14 fastening screws by arranging the single shorter screw "A" and the single longer screw "B" as shown in the figure.
- Tighten the screws thoroughly and tighten to the prescribed torque.
- Check that the crankshaft rotates freely.

**N.B.**

**REMOVE ANY EXCESS FROM THE CRANKCASE COUPLING GASKET ON THE CYLINDER PLANE, TO ENSURE BETTER SEALING PERFORMANCE.**

**Locking torques (N\*m)****Engine-crankcase coupling screws 11 ÷ 13**

- Install the thermal unit (cylinder, head, piston) as described in section "Thermal unit and timing system".
- Install the flywheel with start-up control as described in the "Flywheel and start-up" chapter.
- Install the flywheel cover with the cooling system sleeves, as described in the "Flywheel cover chapter".
- Install the complete driving pulley, the transmission cover and the relevant mesh filter and the outside transmission cover as described in the section "Automatic transmission".

**See also**

[Cylinder assy. and timing system](#)

[Flywheel cover](#)

**Lubrication****TECHNICAL SPECIFICATIONS****SUMP CAPACITY**

Specification	Desc./Quantity
Overhaul	1.7 l
Oil and filter replacement	1.5 l

**RECOMMENDED ENGINE OIL**

Product	Description	Specifications
AGIP CITY HI TEC 4T	Engine oil	SAE 5W-40, API SL, ACEA A3, JASO MA Synthetic oil

**OIL PUMP**

Specification	Desc./Quantity
Type	Trochoidal
Rotor thickness	8 mm
Assembly clearances	Lobe ends 0.05-0.008 mm
Outside rotor radial clearance	0.05- 0.12 mm
Rotor axial clearance	0.025 - 0.065 mm

**BY-PASS**

Specification	Desc./Quantity
Type	piston

Specification	Desc./Quantity
Plunger diameter	13.9 - 0.039 -0.057 mm
Spring free length	62.5 mm
Calibration pressure	4 bar

#### **PRE-FILTER**

Specification	Desc./Quantity
Type	mesh, plastic

#### **OIL FILTER**

Specification	Desc./Quantity
Type	Paper with pressure relief and anti-cavitation by-pass

#### **OIL MINIMUM PRESSURE INDICATOR LIGHT SWITCH**

Specification	Desc./Quantity
Calibration	0.3 - 0.6 bar

#### **HEAD LUBRICATION CONTROL JET**

Specification	Desc./Quantity
Diameter	1 ± 0.05 mm *

\* Tightening torque 5÷7 N·m

#### **PISTON COOLING NOZZLE**

Specification	Desc./Quantity
Diameter	0.8 ± 0.05 mm

#### **BASE VENTILATION CHECK**

Specification	Desc./Quantity
Device	decantation chamber and metal reed valve

## Conceptual diagrams

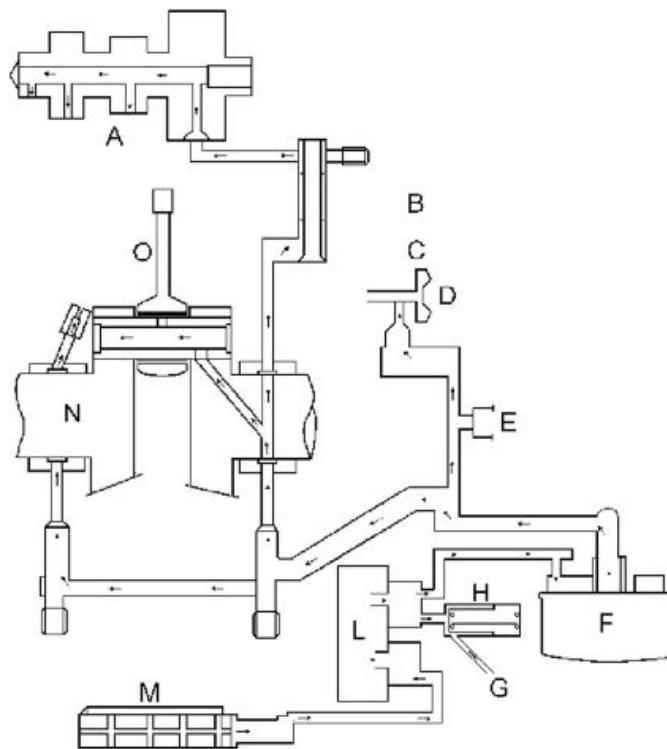

**PRINCIPLE DIAGRAM**

Specification	Desc./Quantity
A	Camshaft
B	Cylinder-head plane
C	Cylinder-crankcase plane
D	Water pump impeller
E	Minimum oil pressure sensor
F	Oil filter cartridge
G	To the oil sump
H	By-pass valve
L	Oil pump
M	Mesh pre-filter
N	Crankshaft
O	Connecting rod

## General characteristics

Lubrication circuit is split into two sections:

- **High pressure**

- **Low pressure**

The high pressure section includes all components located on the engine crankcase, while the low pressure section only refers to the thermal unit.

The trochoidal pump is installed into the sump and is controlled through a couple of gears.

To guarantee the integrity of the pump, a pre-filter is installed.

The pre-filter is of the screw-in type and the plug serves at the same time as an engine oil drain plug.

The pump is controlled by means of a piston by-pass calibrated to 4 bar. This is located before the cartridge filter and both are installed on the flywheel cover, so that the seal of the filter is subject to the pressure of the circuit.

The by-pass located before the cartridge filter improves the operating conditions for the filter proper, particularly with cold oil.

The filter is equipped with an anti-cavitation valve and a pressure relief valve; the latter intervenes when the filtering element causes a pressure drop exceeding  $1 \pm 0.2$  bar.

These conditions naturally occur only with cold oil and at high engine revs or if the filter is clogged.

The filtered oil is used to lubricate the shaft of the water pump and once at the engine crankcase, to lubricate the crankcase bearings, the connecting rod head and the piston cooling nozzle located on the bearings on the transmission side.

The crankcase bearing on the transmission side is provided with an oil seal and the respective drain line.

The supply line for the timing system comes from the flywheel-side bearing; the supply to the head is controlled by the respective spray jets in the engine crankcase.

The components of the timing system function with low-pressure oil.

The camshaft bearings are marked directly on the aluminium of the head; the axial clearance of the camshaft is partly compensated by the oil supplied to the small end bearings.

The camshaft supplies the lubricant to the rocking levers via the bores provided; these are installed in a position to ensure that the lubrication is maintained even after the scooter has stopped. This is achieved when the camshaft reaches its most usual and likely position when the engine is switched off.

The oil used to lubricate the head returns to the sump via the ducts in the chain casing and hence also provides lubrication for the chain.

In order to avoid the gas collecting in the bottom of the tank carrying oil out of the housing, a non-return valve and a decantation chamber are used. The one-way valve is of metal sheet design; the decantation chamber is provided with a drainage bore. If they fail oil can get into the pipe supplying air to the engine. Excessive oil vapours may result in a blockage in the ducts of the throttle body.

In order to signal low oil pressure in the circuit, a pressure switch is used, located immediately after the oil filter outlet.

The lubrication circuit does not include the countershaft; its lubrication comes from the oil transported by the gearing or by the centrifugal effect of the crankshaft.

The same applies to the piston or the pin, but in this case the cooling nozzle is particularly important.

---

## Diagnosis guide

**1** - Minimum oil pressure warning light on with hot engine.

AHEAD - go to 2

**2** - Remove the minimum pressure switch electric connector.

Check that the warning light turns off.

YES go to 3 NO go to 11

**3** - Check the actual oil pressure.

AHEAD - go to 4

**4** - Remove the switch and install the special tool with the relevant gasket.

### Specific tooling

**020193Y Oil pressure gauge**

**020434Y Oil pressure control fitting**

- Remove the bar with the oil filler plug and insert a cap with the temperature probe supplied with the special tool. Insert the probe to feel contact with the case bottom and pull back a few millimetres.

### Specific tooling

**020331Y Digital multimeter**

AHEAD - go to 5



**5** - Measure pressure with cold and idling engine.

### STANDARD VALUES

Specification	Desc./Quantity
20°C Temperature	
1400 rpm	

*approx. 4.5 bar*

**N.B.**

**RPM CAN BE MEASURED BOTH BY THE EXHAUST GAS ANALYSER AND BY THE DIAGNOSTIC TESTER**

### Specific tooling

**020460Y Scooter diagnosis and tester**

YES go to 6 NO go to 12

**6** - Let the engine warm up and repeat the check with hot engine.

### STANDARD VALUES

Specification	Desc./Quantity
80°C Temperature	
1400 rpm	

*approx. 1.5 bar*

YES go to 7 NO go to 8

7 - Replace the oil minimum pressure switch.

8 - If pressure lower than 1.3 - 1.5 bar is measured.

AHEAD go to 9

9 - Replace the oil filter and repeat the pressure check with oil at 80°C.

YES go to 10 NO go to 13

10 - The failure was fixed.

It is recommended to respect the suggested number of kilometres covered.

11 - Check and restore the electrical system.

12 - If pressure lower than 4 bar is measured.

AHEAD go to 9

13 - Remove the flywheel cover and check the by-pass and the cover sealing gasket efficiency towards the case internal side, as described in the "Flywheel cover" chapter.

YES go to 14 NO go to 15

14 - Check whether there is an irregular clearance on the crankshaft:

- axial clearance (see the "Crankcase and crankshaft" chapter)

- radial clearance, especially in the direction of the cylinder axis

- clearance according to the direction of rotation with the connecting rod in quadrature

YES go to 16 NO go to 17

15 - Replace the faulty components ("Flywheel cover" chapter).

16 - Overhaul the engine ("Crankcase and crankshaft" chapter).

17 - Open the engine crankcase and remove the oil pump, as described in the "Crankcase and crankshaft" chapter.

- Check the oil pump as described in the following pages.

- Check that the cooling nozzle and the timing feeding jet are properly installed.

- Visually inspect the crankshaft couplings and their size ("Crankcase and crankshaft" chapter).

**N.B.**

**ANY FAILURES OF THE COUPLINGS AND OF THE TIMING COMPONENTS CANNOT BE DETECTED BY THE INSPECTION OF THE LUBRICATION PRESSURE. THE FAILURES MAY BECOME EVIDENT BY AN INCREASE OF NOISE.**

**N.B.**

**IN CASE OF IRREGULAR PRESSURE ON THE BASE, CARRY OUT A VISUAL AND DIMENSIONAL INSPECTION OF THE TIMING COMPONENTS (SEE THERMAL UNIT AND TIMING SYSTEM CHAPTER).**

---

## Oil pressure check

1 - In case of oil leaks from the oil filter or from the flywheel cover coupling gasket, check the lubrication pressure.

AHEAD go to 2

2 - Install the special tool.

### Specific tooling

**020193Y Oil pressure gauge****020434Y Oil pressure control fitting**

AHEAD go to 3

**3** - Check the system pressure with cold engine and medium - high speed.

Standard pressure < 6 bar

YES go to 4 NO go to 5

**4** - Replace the damaged components.

**5** - Check the adjustment by-pass efficiency (see "Flywheel cover" chapter) and restore the proper sliding.

**N.B.**

**STANDARD PRESSURES ARE OBTAINED USING OIL WITH THE PRESCRIBED VISCOSITY. A HIGHER VISCOSITY CAUSES AN INCREASE OF THE SYSTEM PRESSURE.**

**1** - If oil consumption is higher than 250 g/1000 km on run-in engine, proceed as follows.

AHEAD go to 2

**2** - Check the presence of oil at the recovery duct on the filter box.

YES go to 3 NO go to 4

**3** - Check the unidirectional reed valve and the decantation chamber drainage hole.

YES go to 5 NO go to 4

**4** - Check the thermal unit seals (piston rings, valve guides and oil guards), see "Thermal unit and timing system" chapter.

**5** - Restore the valve or the drainage hole efficiency.

---

## Oil pump

---

### Removal

- Remove the closing plate of the oil pump housing by loosening the 2 retaining screws with their washers.



- 
- Remove the oil pump complete with the gearing by loosening the 2 retaining screws through the eyes machined in the gearing proper.



- 
- Remove the gasket.



- 
- Remove the two screws and the oil pump cover.

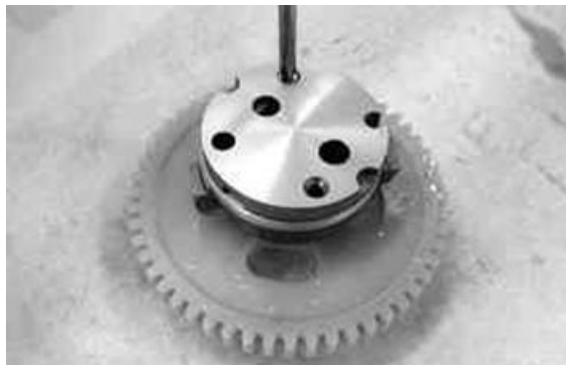

- 
- Remove the inside rotor retaining snap ring turning it to move the opening at the shaft face.





- Remove and wash the rotors thoroughly with petrol and compressed air.
- Extract the shaft with its gear and check that it is in good working order and free from wear.



- Reassemble the rotors in the pump body, keeping the two reference marks visible
- Insert the shaft with the gear and install the lock ring; then, turn it with the opening opposed to the shaft face.
- Check any irregular clearance between shaft and pump body.



- Using a thickness gauge, check the distance between the rotors in the position shown in the figure.

**Characteristic**

**Admissible limit clearance:**

0.012 mm



- Check the distance between outside rotor and pump body; see figure.

**Characteristic**

**Admissible limit clearance:**

0.25 mm



- Check the rotor axial clearance using a rectified bar as reference plane, as shown in the figure.

### Characteristic

#### Limit values admitted:

0.1 mm



## Refitting

- Make sure the gasket is in the correct position.

**N.B.**

**THE TOOTH OF THE GASKET MUST BE IN ITS SEAT.**



- Lubricate the internal rotors.
- Check there are no signs of scoring or wear on the oil pump cover.
- If non-conforming values or signs of wear are found, replace the pump.
- Fit the pump cover in the position that permits the crankcase fixing screws to be aligned.
- Tighten the two fastening screws to the prescribed torque.



### Locking torques (N\*m)

**Oil pump cover screws 0.7 ÷ 0.9**

- Insert the oil pump with gear
- Insert the 2 retaining screws through the slots on the gear and tighten to the prescribed torque.

**N.B.**

**THE ASSEMBLY POSITION OF THE PUMP IS FIXED BY INSTALLATION OF THE SCREWS.**

---

Failure to observe the tightening torque may alter the coupling clearance of the rotors with the pump body.

**Locking torques (N\*m)****Screws fixing oil pump to the crankcase 5 - 6**

- Insert the countershaft with gearing into the fly-wheel-side half-crankcase.
- Install the special tool in the position shown in the figure.

**Specific tooling****020479Y Countershaft lock wrench**

- Keep the countershaft in position and insert the washer with the nut.
- Tighten the nut to the prescribed torque, using the recommended product.
- Remove the special tool.

**Recommended products****Loctite 243 Medium strength threadlock**

Medium Loctite 243 threadlock

**Locking torques (N\*m)****Countershaft fixing nut 25 - 29**



## INDEX OF TOPICS

INJECTION

INJEC

**KEY:**

1. Throttle body and injection electronic control unit (MIU)
2. Battery
3. Instrument panel
4. Injection load remote control
5. Coolant temperature sensor
6. HV coil
7. Fuel pump
8. Lambda probe
9. Revolution sensor
10. Fuel injector
11. Diagnosis connector

**MIU injection system**

This vehicle is fitted with an integrated injection and ignition system.

Injection is indirect in the manifold through an electro-injector.

The injection and ignition are timed on the four-stroke cycle by means of a tone wheel keyed on to the crankshaft (24-2 teeth) and pick-up sensor.

Combustion and ignition are managed on the basis of engine revs and throttle valve opening. Further corrections are made according to the following parameters:

- Coolant temperature.
- Intake air temperature
- Lambda probe strength

The system implements an idle feeding correction with cold engine through a Stepper motor on a by-pass circuit of the throttle valve. The control unit manages the Stepper motor and the injector opening time, thereby ensuring the idle steadiness and the proper combustion.

In all conditions of use, mixture preparation is managed by modifying the injector opening time.

The fuel supply pressure is kept constant based on the ambient pressure.

The **fuel supply circuit** consists of:

- Fuel pump
- Fuel filter
- Injector
- Pressure regulator

The pump, the filter and the regulator are placed inside the fuel tank on a single support.

The injector is connected by a pipe with fast-release fittings. The pressure regulator is located at the beginning of the circuit.

The fuel pump is controlled by the MIU control unit ; this ensures the scooter safety

The **ignition circuit** consists of:

- HV coil
- HV cable
- Shielded cap
- MIU control unit
- Spark plug

The MIU control unit manages ignition with the best advance ensuring four-stroke timing (ignition only in the compression phase) at the same time.

The MIU injection-ignition system controls engine functions by means of a pre-set program.

Should any input signals fail, an acceptable working order of the engine is ensured to allow the user to reach a service station.

Of course, this cannot happen when the rev counter signal is missing, or when the failure involves the control circuits:

- Fuel pump
- HV coil
- Injector

The control unit is provided with a self-diagnosis system connected to an indicator light in the instrument panel.

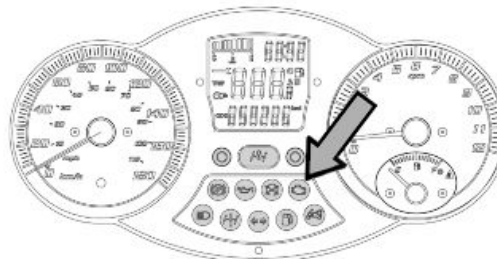

Failures are detected and restored by the diagnostic tester.

In any case, when the fault is no longer present, the data storage is wiped clean after 16 cycles of use (cold start, running at normal engine temperature, stop).

The diagnostic tester is also required for adjusting the idle mixture.



### Specific tooling

#### 020460Y Scooter diagnosis and tester

The MIU injection-ignition system carries out checks on the rpm counter and the electric fan for radiator cooling.

The MIU control unit has a decoder for the anti-theft immobiliser.

The MIU control unit is connected to a diagnostic LED on the instrument panel, that also carries out the deterrent flashing functions.

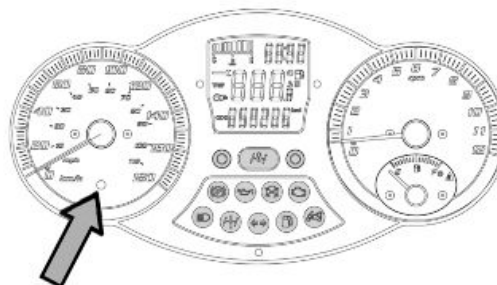

The MIU control unit power supply is furthermore controlled by the emergency switch; that is to provide further safety for the scooter.

### Precautions

1. Before fixing any part of the injection system, check to see if there are any registered faults. Do not disconnect the battery before checking for faults.
2. The feeding system is pressurised at 300 kPa (3 BAR). Before disconnecting the fast-release fitting of the power supply pipe, check that there are no naked flames. Do not smoke. Act with caution to prevent spraying in the eyes.
3. When fixing electric components, operate with battery connected only when actually required.
4. When functional checks are performed, check that the battery voltage is more than 12V.



5. Before trying to start up, check to make sure there is at least two litres of fuel in the tank. Failure to respect this norm will damage the fuel pump.
6. If the scooter is expected to remain unused for a long time, refill the tank up to a little over half the level. This will ensure the pump will be covered by fuel.
7. When washing the vehicle, be careful with the electric components and wiring.
8. When an ignition fault is detected, start the checks from the battery and the injection system connections.
9. Before disconnecting the MIU control unit connector, perform the following steps in the order shown:
  - Set the switch to «OFF»
  - Disconnect the batteryFailure to respect this norm may damage the control unit.
10. Do not invert the polarity when fitting the battery.
11. To avoid damage, only disconnect and reconnect the MIU system connectors if required. Before reconnecting, check that the connectors are dry.
12. When carrying out electric inspections, do not force the tester probes into the connectors. Do not take measurements not specifically foreseen by the manual.
13. At the end of every check performed with the diagnostic tester, protect the system connector with its cap. Failure to do this may damage the MIU control unit.
14. Before reconnecting the quick couplers of the power supply system, check that the terminals are perfectly clean.

### Troubleshooting hints

1 A fault in the MIU system could most likely be due to the connections and not the components. Before troubleshooting the MIU system, carry out the following checks:

**A:** Electrical power supply

- a. Battery voltage
- b. Blown fuse
- c. Remote controls
- d. Connectors

**B:** Chassis earthing

**C:** Fuel supply

- a. Broken fuel pump
- b. Dirty fuel filter

**D:** Ignition system

- a. Faulty spark plug
- b. Broken coil
- c. Broken shielded cap

**E:** Intake circuit

- a. Dirty air filter

- b. Dirty by-pass circuit
- c. Faulty Stepper motor

**F: Other**

- a. Incorrect distribution timing
- b. Wrong idle mixture
- c. Incorrect reset of the throttle valve position sensor

2 MIU system faults may be caused by loose connectors. Make sure that all connections have been correctly made.

Check the connections as follows:

**A** check that the terminals are not bent.

**B** check that the connectors have been properly connected.

**C** see whether the malfunction can be fixed by shaking the connector slightly.

3 Check the entire system before replacing the MIU. If the fault is fixed by replacing the MIU control unit, install the original control unit again and check if the fault occurs again.

4 When troubleshooting use a multimeter with an internal resistance over 10 Ohm /V. Instruments that are not suitable might damage the MIU control unit. Instruments must be used with definitions over 0.1V and 0.5 W , the precision must be greater than 2%.

**Terminals setup**

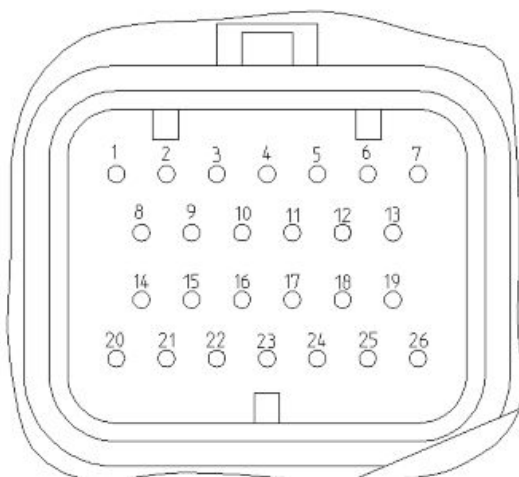

**TERMINAL LAYOUT**

	<b>Specification</b>	<b>Desc./Quantity</b>
1	Injection warning light	
2	Rpm indicator signal	
3	Can «L» Line	
4	- Lambda probe	
5	+ battery under permanent power supply	
6	+ Battery	
7	Immobilizer aerial	
8	Electric fan starter	

Specification	Desc./Quantity	
9	Water temperature sensor	
10	Can «H» Line	
11	+ Lambda probe	
12	Engine stop switch	
13	R.P.M. sensor (+)	
14	Fuel injector	
15	R.P.M. sensor (-)	
16	Diagnostics socket output	
17	Immobilizer LED	
18	Ground lead	Connected to the engine stop switch and the water temperature sensor.
19	-	
20	Injection load remote control	
21	-	
22	HV coil	
23	-	
24	Start up enabling	
25	-	
26	Ground lead	

**EMS circuit diagram**

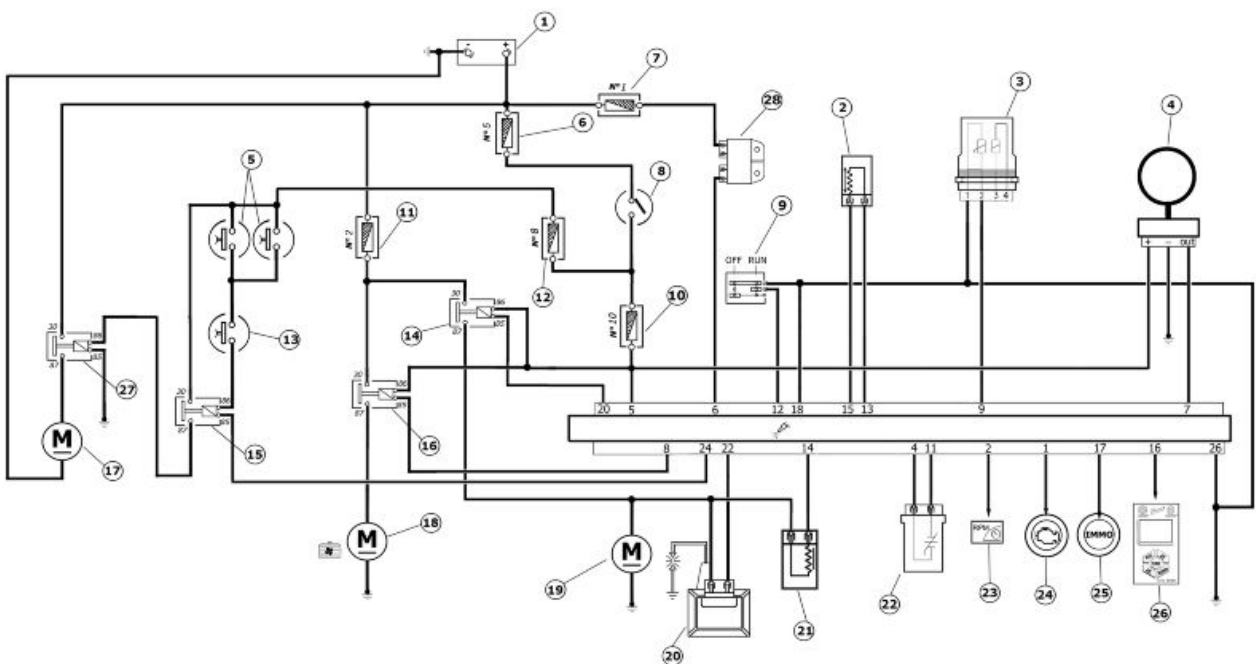

**SYSTEM SCHEMATIC**

Specification	Desc./Quantity
1	Battery 12V - 12 Ah
2	Engine rpm sensor
3	Water temperature sensor
4	Immobilizer aerial
5	Stop button

	<b>Specification</b>	<b>Desc./Quantity</b>
6	Fuse	20 A
7	Fuse	7.5 A
8	Key switch contacts	
9	Engine stop switch	
10	Fuse	7.5 A
11	Fuse	15A
12	Fuse	10 A
13	Starter button	
14	Injection load remote control	
15	Start-up remote control relay	
16	Electric fan starter	
17	Starter motor	
18	Electric fan	
19	Fuel pump	
20	HV coil	
21	Fuel injector	
22	Lambda sensor	
23	Rpm indicator	
24	"WARNING" light	
25	Immobilizer LED	
26	Diagnostics socket connector	
27	Starter remote control	
28	Control unit power device	

## Troubleshooting procedure

### Engine does not start

#### **ENGINE DOES NOT START IF ONLY PULLED**

<b>Possible Cause</b>	<b>Operation</b>
Immobiliser enabling signal	System not encoded System not efficient, repair according to the indications of the self-diagnosis
Presence of faults detected by the self diagnosis	Pump relay HV coil Injector revolution timing sensor
Fuel supply	Presence of fuel in the tank Activation of the fuel pump Fuel pressure (low) Injector capacity (low)
Power to the spark plug	Shielded spark-plug cap HV coil (secondary insulation)
Parameter reliability	Coolant temperature. Distribution timing - injection ignition - Intake air temperature
End of compression pressure	End of compression pressure

## Starting difficulties

### ENGINE START-UP PROBLEMS

Possible Cause	Operation
Presence of faults detected by the self diagnosis	Pump relay HV coil Injector revolution timing sensor Air temperature Coolant temperature.
Start up engine speed	Starter motor and remote control Battery Earth connections
End of compression pressure Power to the spark plug	End of compression pressure Spark plug Shielded cap HV coil Phase rpm sensor - Ignition advance
Fuel supply	Fuel pressure (low) Injector capacity (low) Injector seal (poor)
Correctness of the parameters	Coolant temperature. Stepper throttle valve position intake air temperature (steps and actual opening) Cleaning of the auxiliary air pipe and air filter efficiency gas valve

## Engine stops at idle

### ENGINE DOES NOT HOLD IDLING/ IDLING IS UNSTABLE/ IDLING TOO LOW

Possible Cause	Operation
Presence of faults detected by the self diagnosis	Pump relay HV coil Injector revolution timing sensor Air temperature Coolant temperature.
Ignition efficiency	Spark plug Ignition timing
Correctness of the parameters	Throttle valve position sensor Stepper Coolant temperature sensor Intake air temperature sensor
Intake system cleaning	Air filter Diffuser and gas sensor Supplementary air pipe Stepper
Intake system seal (infiltrations)	Intake manifold - head throttle body - manifold Intake manifold Filter box
Fuel feed (low pressure)	Fuel pump Pressure regulator

**Possible Cause****Operation**

Fuel filter  
Injector capacity

**Engine does not rev down****ENGINE DOES NOT RETURN TO THE IDLING SPEED/IDLING SPEED TOO HIGH****Possible Cause****Operation**

Presence of faults detected by the self diagnosis

Pump relay  
HV coil  
Injector  
revolution timing sensor  
Air temperature  
Coolant temperature.

Ignition efficiency

Ignition timing

Correctness of the parameters

Throttle valve position sensor  
Stepper  
Coolant temperature sensor  
Intake air temperature sensor

Intake system seal (infiltrations)

Intake manifold - head  
throttle body - manifold  
Intake manifold  
Filter box

Fuel feed (low pressure)

Fuel pump  
Pressure regulator  
Fuel filter  
Injector capacity

**Exhaust backfires in deceleration****EXHAUST BACKFIRES WHEN DECELERATING****Possible Cause****Operation**

Presence of faults detected by the self diagnosis

Pump relay  
HV coil  
Injector  
revolution timing sensor  
Air temperature  
Coolant temperature.  
Lambda sensor

Correctness of the parameters

Throttle valve position sensor  
Stepper  
Coolant temperature sensor  
Intake air temperature sensor

Intake system seal (infiltrations)

Intake manifold - head  
throttle body - manifold  
Intake manifold  
Filter box

Fuel feed (low pressure)

Fuel pump  
Pressure regulator  
Fuel filter  
Injector capacity

Exhaust system seal (infiltrations)

Manifold - cylinder head  
Manifold - muffler

Possible Cause	Operation
	Muffler welding

**Engine revs irregularly**

**IRREGULAR PROGRESS OF THE ENGINE WITH VALVE SLIGHTLY OPEN**

Possible Cause	Operation
Intake system cleaning	Air filter Diffuser and gas sensor Supplementary air pipe Stepper
Intake system seal	Intake manifold Filter box
Ignition system	Spark-plug wear control
Parameter reliability	Throttle valve position signal coolant temperature signal Intake air temperature indicator - Ignition advance
TPS reset successful	TPS reset successful
Presence of faults detected by the self diagnosis	Pump relay HV coil Injector revolution timing sensor Air temperature Coolant temperature. Lambda sensor

**Poor performance at full throttle**

**POOR ENGINE PERFORMANCE AT FULL POWER/ IRREGULAR ENGINE PROGRESS ON PICKUP**

Possible Cause	Operation
Presence of faults detected by the self diagnosis	Pump relay HV coil Injector revolution timing sensor Air temperature Coolant temperature. Lambda sensor
Spark plug power supply	Spark plug Shielded cap HV Cable. HV coil
Intake system	Air filter Filter box (seal) Intake hose (seal)
Parameter reliability	Throttle valve position signal coolant temperature signal Intake air temperature indicator - Ignition advance
Fuel supply	Fuel level in the tank Fuel pressure Fuel filter Injector capacity

---

## Engine knocking

### **PRESENCE OF KNOCKING (OVERHEAD KNOCKING)**

<b>Possible Cause</b>	<b>Operation</b>
Presence of faults detected by the self diagnosis	Pump relay HV coil Injector revolution timing sensor Air temperature Coolant temperature. Lambda sensor
Ignition efficiency	Spark plug
Parameter reliability	Throttle valve position signal coolant temperature signal Intake air temperature indicator - Ignition advance
Intake system seal	Intake manifold Filter box
TPS reset successful	TPS reset successful
Fuel supply	Fuel pressure Fuel filter Injector capacity Fuel quality
Selection of the cylinder base gasket thickness	Selection of the thickness of the cylinder base liner

## Fuel supply system

The fuel supply circuit includes the electric pump, the filter, the pressure regulator, the electro-injector and the fuel delivery pipes.

The electrical pump is located in the tank from which the fuel is pumped and sent to the injector through the filter.

The pressure is controlled by the pressure regulator situated in the pump assembly in the tank.



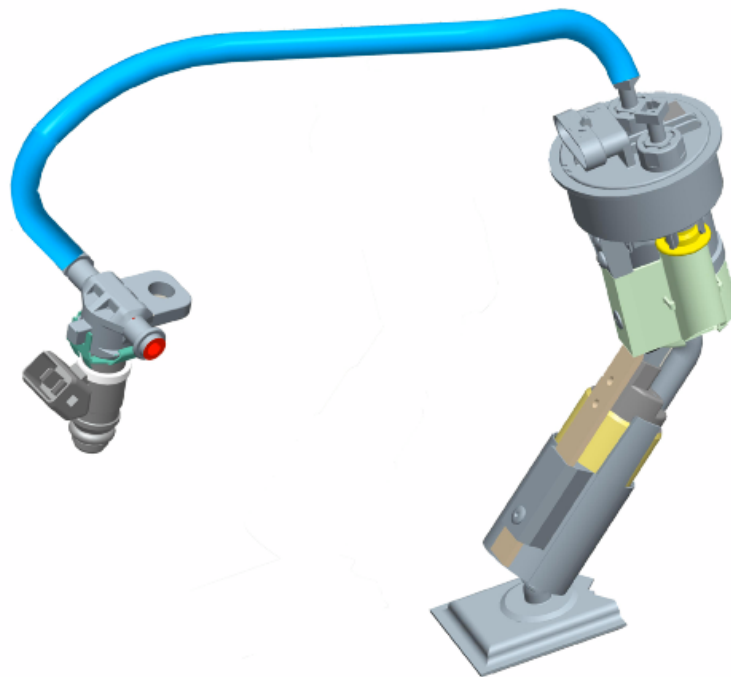

---

### Removing the butterfly valve

Remove the fuel piping clamping screw indicated in the figure.

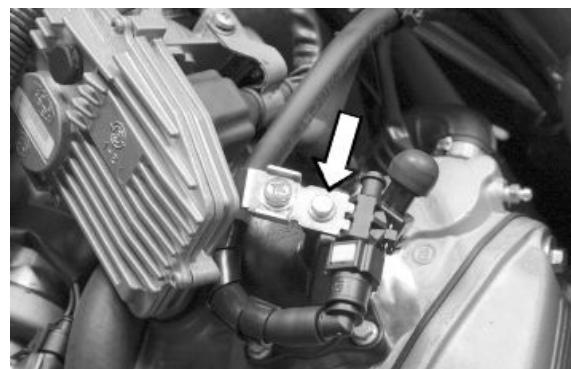

Remove the fast-release fitting from the injector support

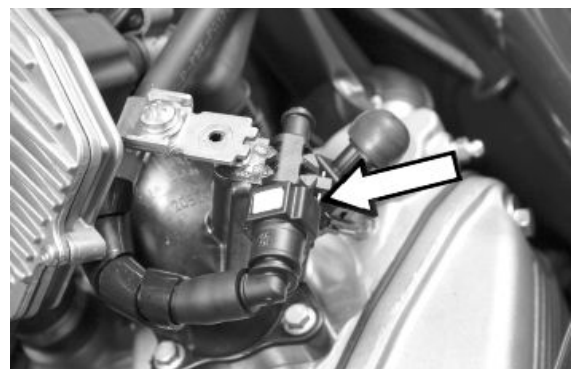

---

Remove the injector connector

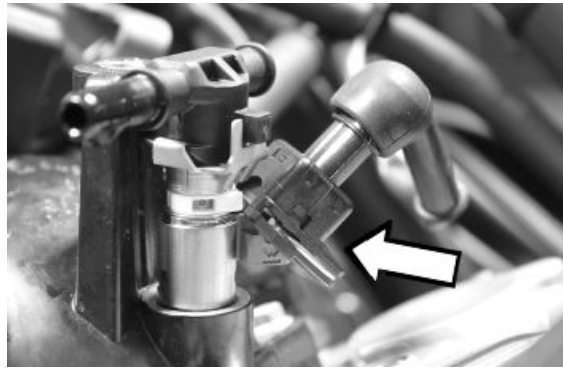

Remove the three screws fixing the manifold to the cylinder head and the clip fixing the throttle body to the manifold.

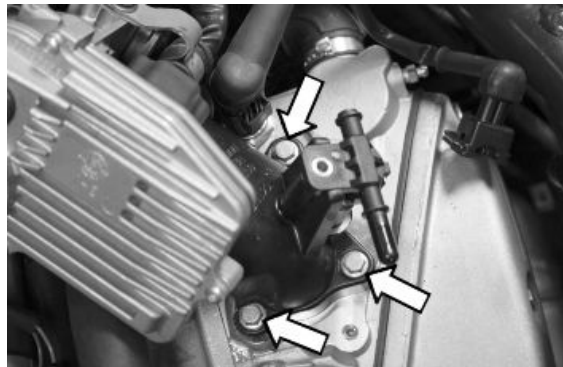

Remove the MIU connector

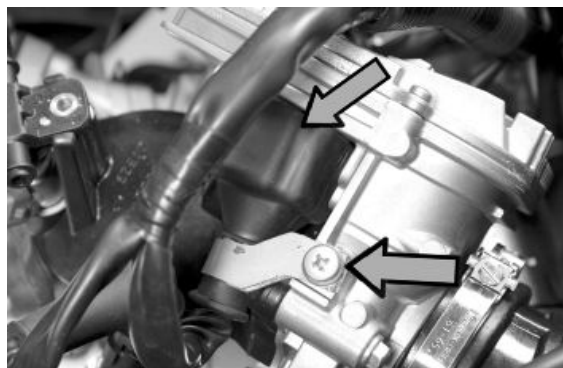

Remove the gas command fitting as indicated in the photograph

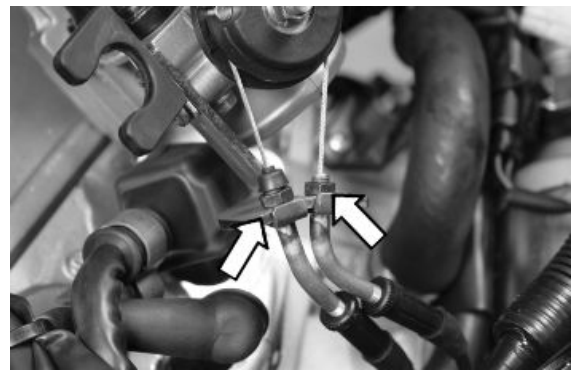

Pump supply circuit

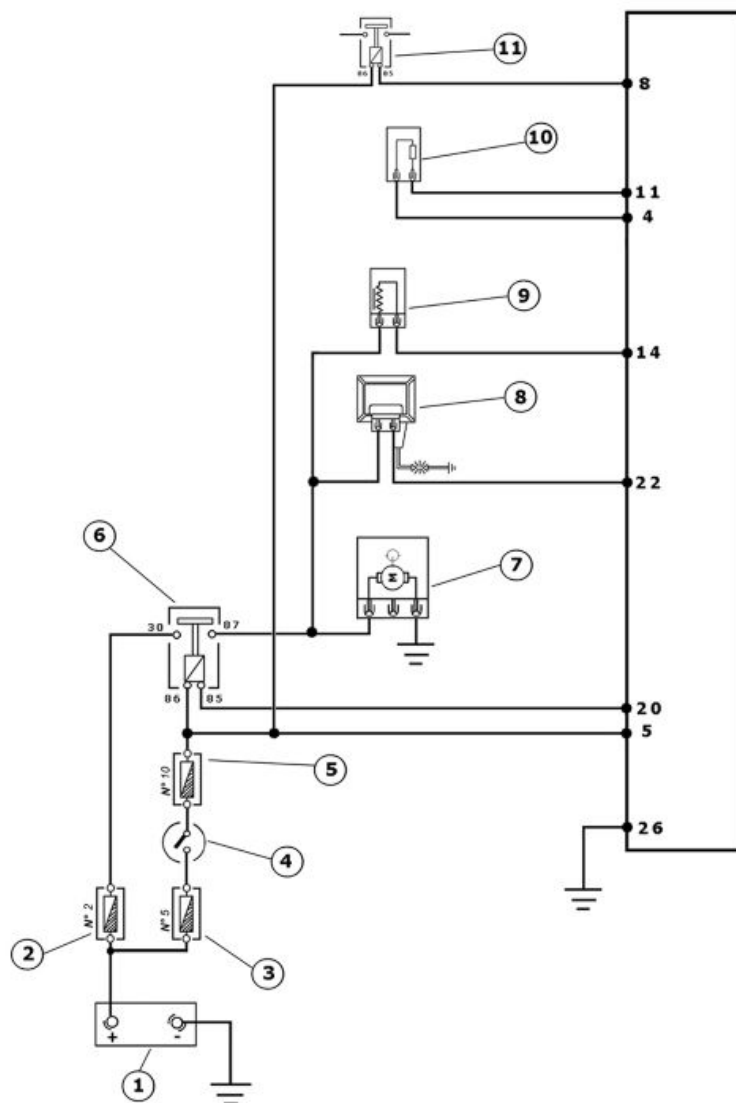

**INJECTION LOADS**

	<b>Specification</b>	<b>Desc./Quantity</b>
1	Battery	12V - 12 Ah
2	Fuse	15A
3	Fuse	20A
4	Key switch contacts	
5	Fuse	7.5 A
6	Injection load remote control	
7	Fuel pump	
8	HV coil	
9	Fuel injector	
10	Lambda sensor	
11	Electric fan starter	

When switched to «ON», the fuel pump starts to rotate for 2 seconds and then stops. When the engine starts up, in the presence of phase rpm signal the pump is continuously supplied.

**ELECTRICAL DATA**

- Pump winding resistance ~ 1.8 Ohm
- Input current during regular functioning 2.8 A

Check that the injection load 15A fuse No. 2 works properly.

Check that the live control unit power supply 7.5A fuse No. 10 works properly.

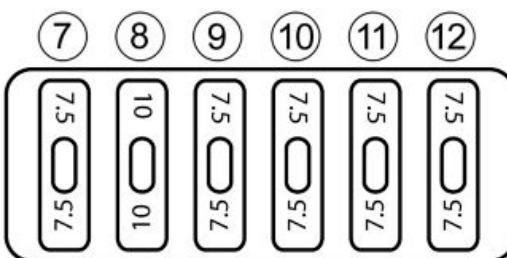
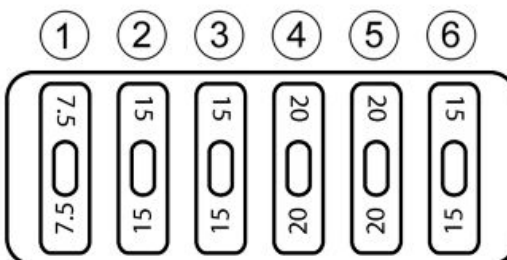

Check the efficiency of the injection load remote control: Check the resistance of the energising coil between pins 86 and 85: 40 to 80 Ohm  
Apply a voltage of 12V to pins 86 and 85; make sure that there is continuity between pins 30 and 87 of the remote control.

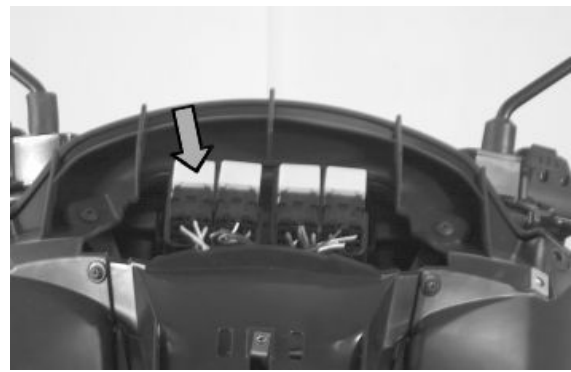

Check the power supply line of the injection load remote control energising coil: after switching to «ON», make sure there is battery voltage, for 2 seconds, between the Red-White cable and the Black-Purple cable of the remote control base. If there is not, check the continuity of the Red-White cable between fuse box and the remote control base and of the Black-Purple cable between the pin 20 of the control unit and the remote control base.

**N.B.**

**CONTINUITY TESTS MUST BE CARRIED OUT WITH THE COMPONENTS DISCONNECTED. (REMOTE CONTROLS, CONTROL UNIT, FUSES ETC.).**

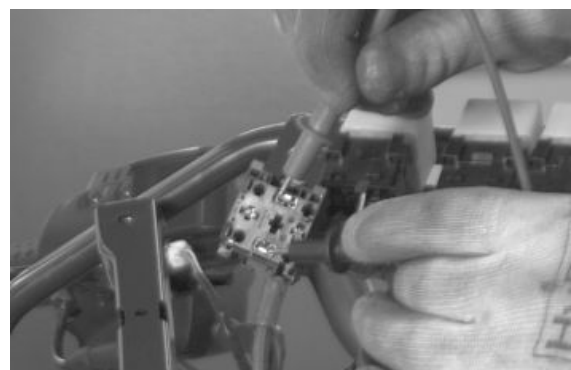

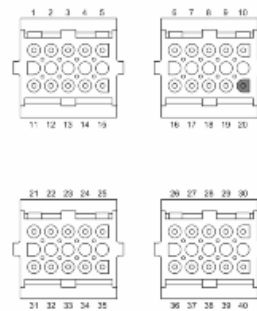
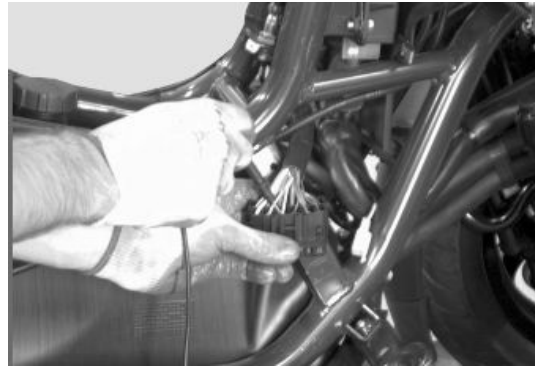

Check the presence of fixed voltage between the grey/black cable of the remote control base and earth. If there is none check the continuity of the grey/black cable between the fuse box (No. 2 15 A) and the remote control base.

**N.B.**

**CONTINUITY TESTS MUST BE CARRIED OUT WITH THE COMPONENTS DISCONNECTED. (REMOTE CONTROLS, CONTROL UNIT, FUSES ETC.).**



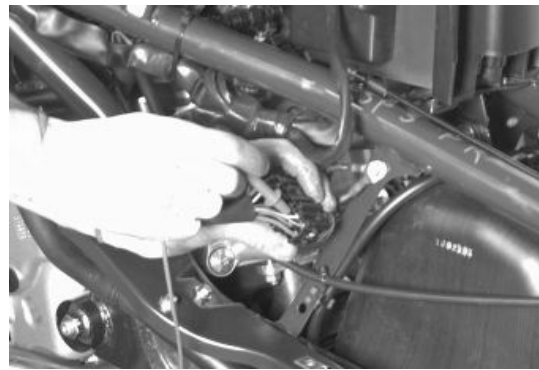

After switching to «ON», check that there is battery voltage, for about 2 seconds, between the Black-Green cable of the pump connector and the ground lead with the pump connector disconnected. Otherwise, check the continuity of the Black-Green cable between the pump connector and the remote control base.

Check the efficiency of the earth line of the fuel pump by measuring the continuity between the pump connector black cable, system side, and the earth.

If, when switching to «ON», the pump continues to turn after 2 seconds of activation, check, with the control unit disconnected and the injection load remote control disconnected, that the Black-Purple cable (pin 20 on the interface wiring) is insulated from the ground.



### **Specific tooling**

**020331Y Digital multimeter**

### **Circuit leak test**

Install the specific tool for checking the fuel pressure, with the pipe fitted with the gauge.

Check during regular functioning by placing the appropriate tool between the pump and the injector.

With battery voltage > 12 V check that the fuel pressure is 3 BAR and that the input current is ~2.8 A



With the battery voltage > 12 V, check the capacity of the pump flow rate by disconnecting from the injector the pipe equipped with the pressure gauge of the appropriate tool. Make a graded burette available with a flow rate of approximately 1 L. Rotate the pump using the active diagnosis of the palm top computer. Using a pair of long flat needle-nose pliers, choke the fuel pipe making the pressure stabilise at approx. 2.9 ÷ 3 BAR. Be careful not to further choke pipes if pressure remains evenly at 3 BAR while flow rate decreases. Check that within 15 seconds the pump has a flow rate of approx. 300 cm<sup>3</sup>.

### Specific tooling

020480Y Petrol pressure check set

### Fuel filter check

Disconnect the terminals from the electric pump

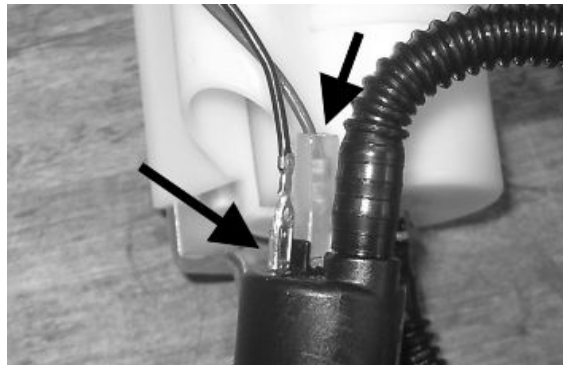

Remove the screw shown in the photograph

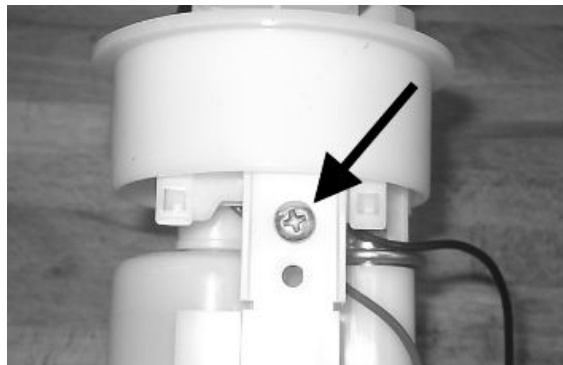



---

Remove the clip fixing the piping to the filter shown in the photograph

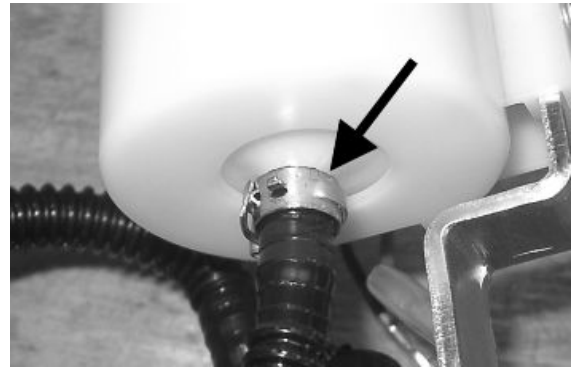

Separate the lower part of the pump support as shown in the photograph.

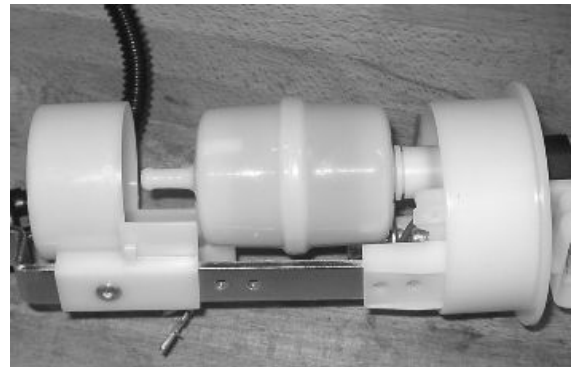

Remove the filter from the pump support

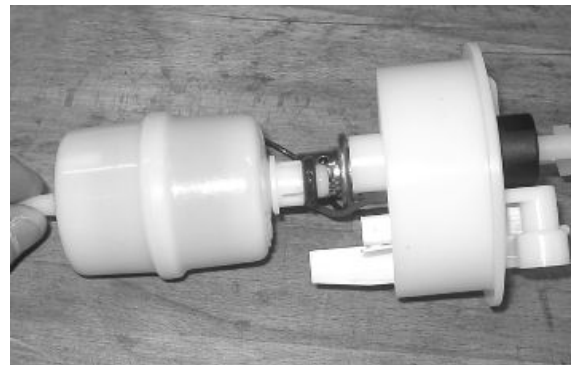

**Inspecting the injector circuit**

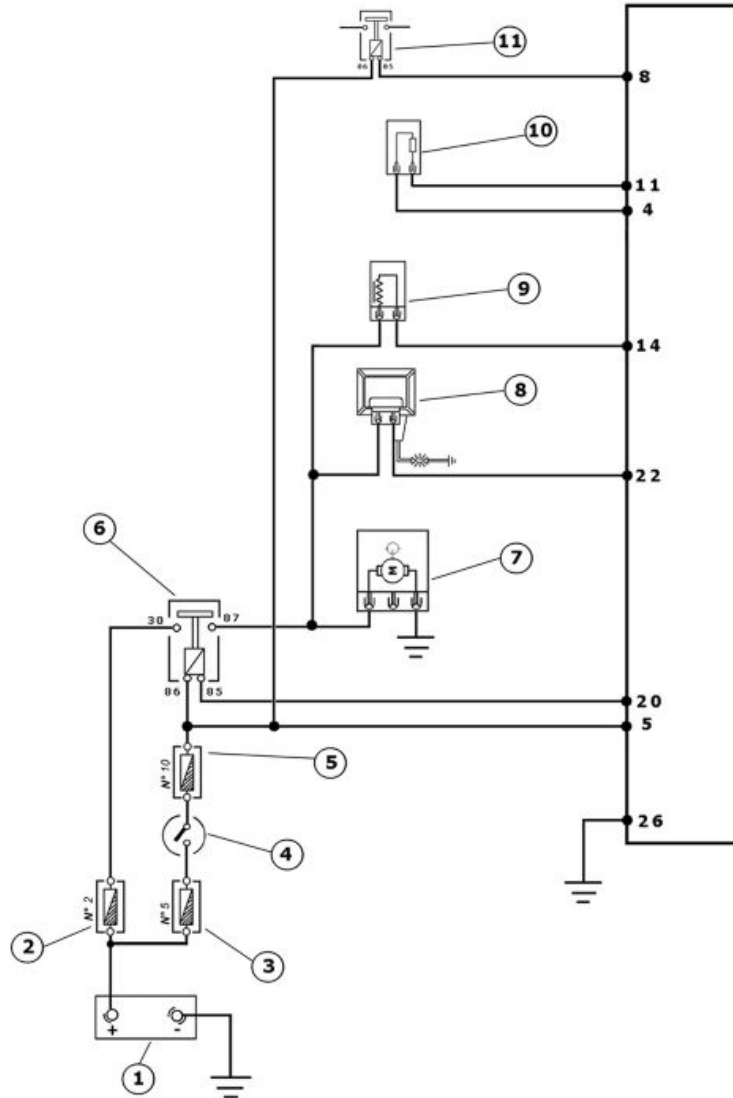

**INJECTION LOADS**

	<b>Specification</b>	<b>Desc./Quantity</b>
1	Battery	12V - 12 Ah
2	Fuse	15A
3	Fuse	20A
4	Key switch contacts	
5	Fuse	7.5 A
6	Injection load remote control	
7	Fuel pump	
8	HV coil	
9	Fuel injector	
10	Lambda sensor	

Specification	Desc./Quantity
11	Electric fan starter

When switched to "ON", the fuel pump starts to rotate for two seconds and then stops. When the engine starts up, in the presence of phase rpm signal the pump is continuously supplied.

ELECTRICAL DATA

- Pump winding resistance ~ 0.8 Ohm
- Input current during regular functioning ~ 2.8 A

Check that the injection load 15A fuse No. 2 works properly.

Check that the live control unit power supply 7.5A fuse No. 10 works properly.

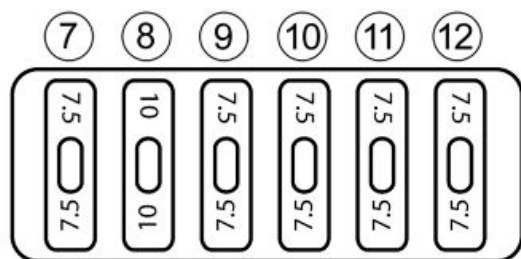
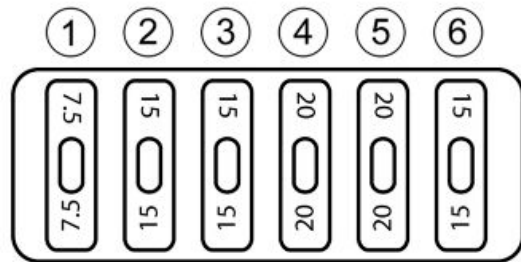

Check the efficiency of the injection load remote control: Check the resistance of the energising coil between pins 86 and 85: 40 to 80 Ohm  
Apply a voltage of 12V to pins 86 and 85; make sure that there is continuity between pins 30 and 87 of the remote control.

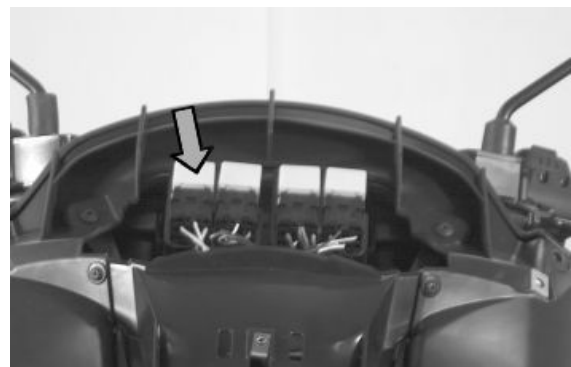



Check the power supply line of the injection load remote control energising coil: after switching to "ON", make sure there is battery voltage, for two seconds, between the Red-White cable and Black-Violet cable of the remote control base. If there is not, check the continuity of the Red-White cable between the fuse box and the remote control base and of the Black-Purple cable between the pin 20 of the control unit and the remote control base.

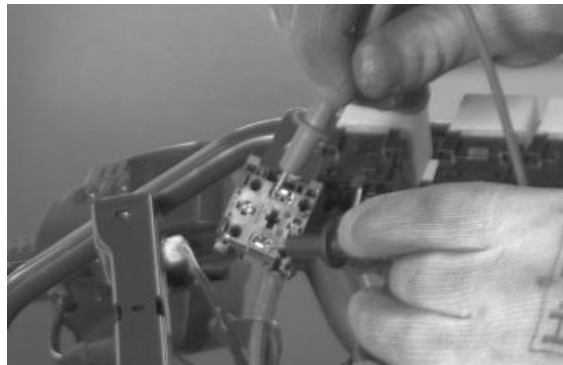

**N.B.**

**CONTINUITY TESTS MUST BE CARRIED OUT WITH THE COMPONENTS DISCONNECTED. (REMOTE CONTROLS, CONTROL UNIT, FUSES ETC.).**



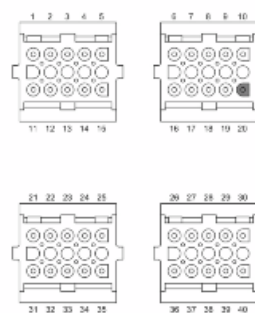

Check the presence of fixed voltage between the grey/black cable of the remote control base and earth. If there is none check the continuity of the grey/black cable between the fuse box (No. 2 15 A) and the remote control base.

**N.B.**

**CONTINUITY TESTS MUST BE CARRIED OUT WITH THE COMPONENTS DISCONNECTED. (REMOTE CONTROLS, CONTROL UNIT, FUSES ETC.).**



With the control unit and the injector disconnected, check the continuity of the Red-Yellow cable between pin 14 of the interface wiring and the injector connector

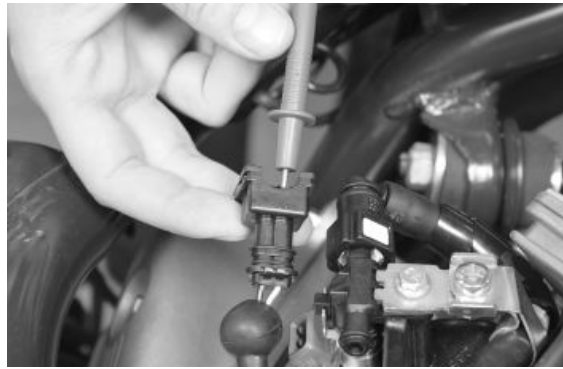

Switch to "ON" and check the presence of voltage, with injector disconnected and control unit connected, between the Black-Green cable of the injector connector and the earth

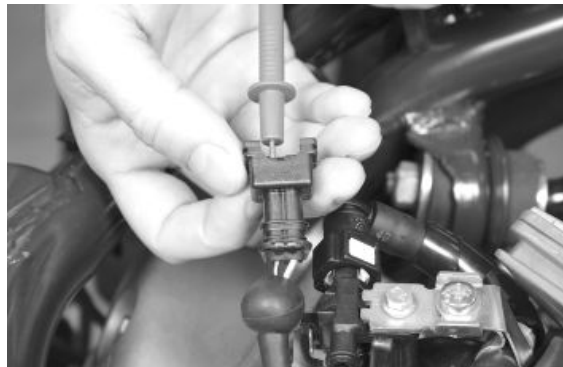

With injector disconnected and the injector load remote control disconnected, check the continuity of the Black-Green cable between the injector connector and remote control base.



## Inspecting the injector hydraulics

To check the injector, remove the inlet manifold by removing the three fixing screws at the head and the three screws connecting the control unit to the manifold.

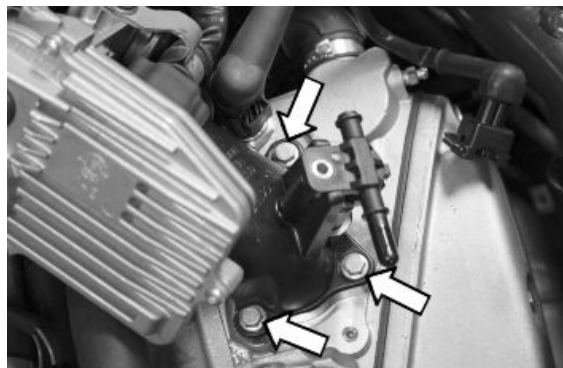

Install the appropriate tool for the fuel pressure check and position the manifold over a container graduated by at least 100 cc. Connect the injector with the cable making up part of the supply for the injection tester. Connect the clamps of the cable to an auxiliary battery. Activate the fuel pump with the active diagnosis. Check that within 15 approx. 70 cm<sup>3</sup> of fuel is delivered with adjustment pressure of approx. 3 BAR.



### Specific tooling

**020480Y Petrol pressure check set**



Proceed with the injector seal test.

Dry the injector outlet with a blast of compressed air. Activate the fuel pump. Wait for one minute, making sure there are no leaks coming from the injector. Slight oozing is normal.

Value limit = 1 drop per minute

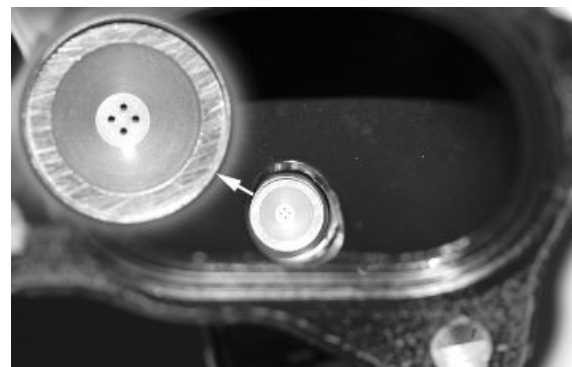

### Immobiliser circuit

After removing the shield back plate, remove the electrical connection from the aerial as shown in the photograph



Remove the protective base from the connector.



With the ignition key switch at ON check there is battery voltage between the Red-White and Black cables

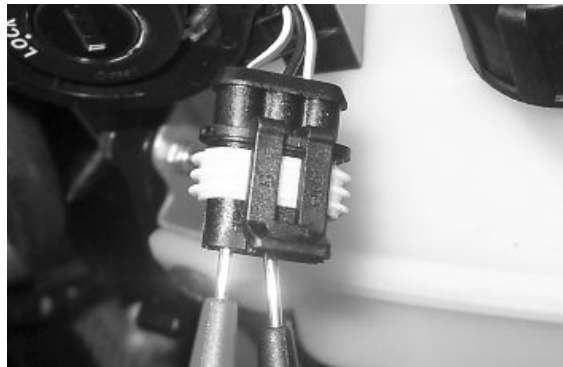

With MIU connector disconnected check the continuity between the Orange-White cable and pin 7 of the interface wiring .

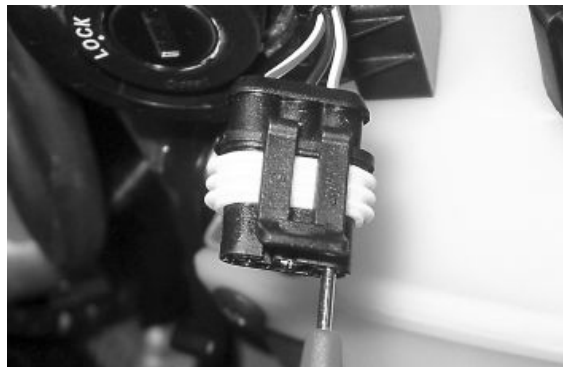

**Specific tooling**

**020481Y Control unit interface wiring**

**020331Y Digital multimeter**

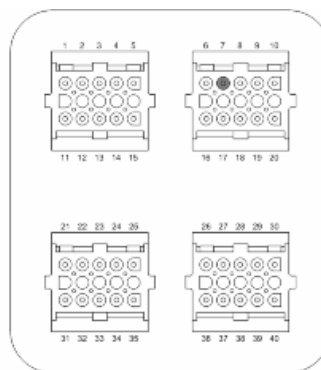



The electronic ignition system is controlled by the control unit with the integrated Immobilizer system. The immobilizer is an antitheft system that allows the vehicle to be operated only when it is started with coded keys recognised by the control unit. The code is integrated in a transponder in the key block. This allows the driver clear operation without having to do anything other than just turning the key. The Immobiliser system consists of the following components:

- electronic control unit
- immobilizer aerial
- Master key with incorporated transponder (red key)
- service key with incorporated transponder (black key)
- HV coil
- Diagnosis LED

The diagnosis LED also works as a blinking light to deter theft. This function is activated every time the ignition switch is turned to the "OFF" position, or the emergency stop switch is turned to the "OFF" position. It remains activated for 48 hours in order not to affect the battery charge. When the ignition switch is turned to the "ON" position, the deterring blinker function is deactivated. Subsequently, a flash confirms the switching to the "ON" status. The duration of the flash depends on the programming of the electronic control unit. If the LED is off regardless of the position of the ignition-key switch and/or the instrument panel is not initiated, check if:

- there is battery voltage
- fuses 1,7,10 are in working order
- there is power to the control unit as specified below:

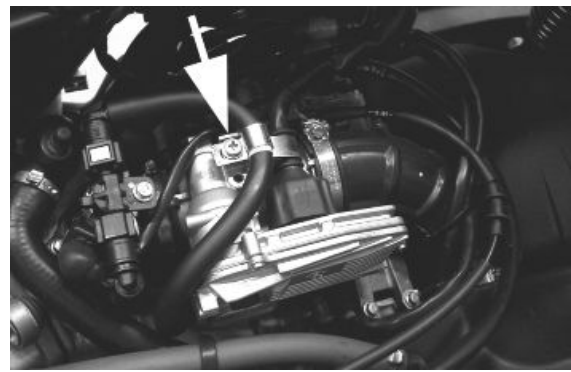

Remove the connector support bracket shown in the photograph and disconnect the connector from the control unit. Check the following conditions:

**With the key switch set to OFF:**

- if there is battery voltage between terminals 6-26 and terminal 6-chassis ground (fixed power supply). If there is no voltage check that fuse 1 and its cable are in working order.

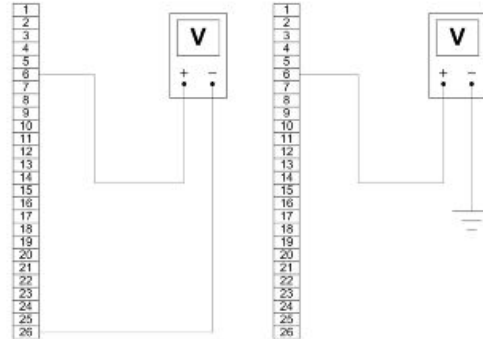

**With the key switch in the OFF position:**

- there is battery voltage between terminals 5-26 and terminal 5-frame earth (fixed power supply). If there is no voltage, check the key switch contacts, that fuse no. 10 and its cable are working order.

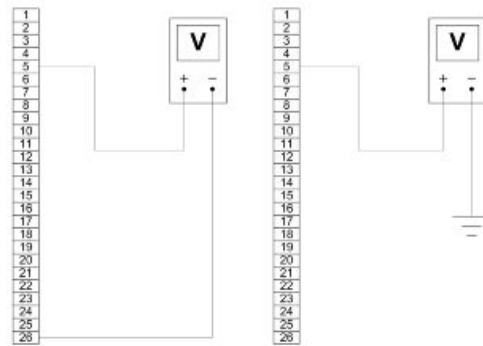

- There is continuity between terminals 12-18 with the emergency cut-off switch in the RUN position. If there is no continuity check the contacts of the switch.

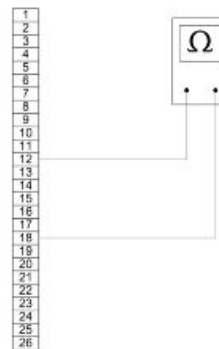

If no faults are found, replace the electronic control unit.

## Virgin circuit

When the ignition system is not encrypted, any key will start the engine but limited to 2000 rpm. The keys can only be recognised if the control unit has been programmed properly. The data storage procedure for a previously not programmed control unit provides for the recognition of the master as the first key to be stored to memory: this becomes particularly important because it is the only key that enables the control unit to be wiped clean and reprogrammed for the memorisation of the service keys. The master and service keys must be used to code the system as follows:

- Insert the Master key, turn it to «ON» and keep this position for two seconds (lower and upper limits 1 to 3 seconds).

- Insert the service key and turn it to «ON» for 2 seconds.
- If you have copies of the key, repeat the operation with each key.
- Insert the MASTER key again and turn it to «ON» for 2 seconds.

The maximum time to change keys is 10 seconds.

A maximum of 7 service keys can be programmed at one time.

It is essential to adhere to the times and the procedure. If you do not, start again from the beginning. Once the system has been programmed, the master key transponder is strictly matched with the control unit. With this link established, it is now possible to encode new service keys, in the event of losses, replacements, etc. Each new programming deletes the previous one so, in order to add or eliminate keys, you must repeat the procedure using all the keys you intend to keep using. If a service key should become un-coded, the efficiency of the high voltage circuit shielding must be thoroughly inspected: In any case it is advisable to use resistive spark plugs.

### Characteristic

#### MASTER key:

RED KEY

#### SERVICE key.

BLACK KEY

## Diagnostic codes

The immobiliser system is tested each time the ignition-key switch is turned from OFF to ON. During this diagnosis phase a number of control unit statuses can be seen and various light codes displayed. Regardless of the code transmitted, if at the end of the diagnosis the led remains off permanently, the ignition is enabled. If, however, the led remains on permanently, it means the ignition is inhibited:

**1. Previously unused control unit - key inserted:** a single 2 second flash is displayed, after which the LED remains off permanently. The keys can be stored to memory, the vehicle can be started but with a limitation imposed on the number of revs.

**2. Previously unused control unit - transponder absent or cannot be used:** The LED is per-

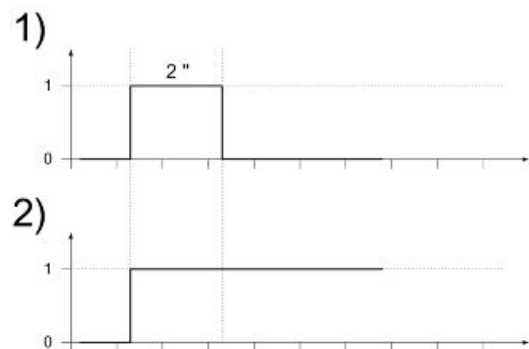

manently ON; in this condition, no operations are possible, including starting of the vehicle.

**3. Programmed control unit - the service key in (normal condition of use):** a single 0.7 second flash is displayed, after which the LED remains off permanently. The engine can be started.

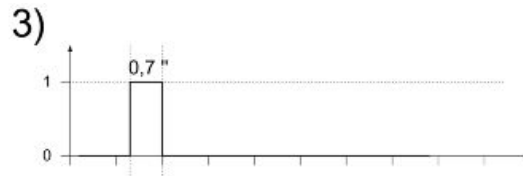

**4. Programmed control unit - Master key in:** a 0.7 sec. flash is displayed followed by the LED remaining off for 2 sec. and then by short 0.46 sec. flashes the same number of times as there are keys stored in the memory including the Master key. When the diagnosis has been completed, the LED remains permanently OFF. The engine can be started.

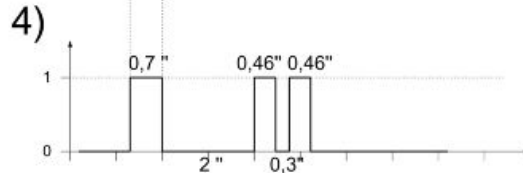

**5. Programmed control unit - fault detected:** a light code is displayed according to the fault detected, after which the LED remains on permanently. The engine cannot be started. The codes that can be transmitted are:

- Code 1 flash
- 2 flash code
- 3 flash code

The LED indication is divided into 3 steps:

1st step: A flash: "ON" switching recognition

2nd step: Series of flashes: diagnosis code indication

3rd step: Solid light on or off:

- ON = start-up disabled

- OFF = start-up enabled

## Code 1

The one-flash code indicates a system where the serial line is not present or is not detected. Check the Immobiliser aerial wiring and change it if necessary.

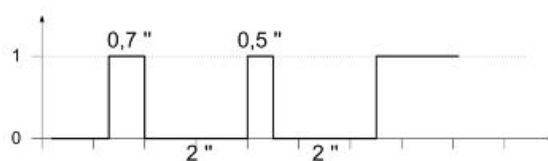

---

## Code 2

---

Two-flash code shows a system where the control unit does not show the transponder signal. This might depend on the inefficiency of the immobiliser aerial or the transponder.

Turn the switch to ON using several keys: if the code is repeated even with the Master key, check the aerial wiring and change it if necessary. If this is not the case, replace the defective key and/or reprogram the control unit. Replace the control unit if the problem continues.

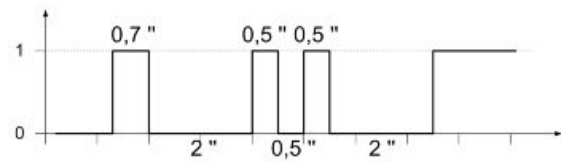

---

## Code 3

---

The three-flash code indicates a system where the control unit does not recognise the key. Turn the switch to ON using several keys: if the error code is repeated even with the Master key, replace the control unit. If this is not the case, perform a re-programming.

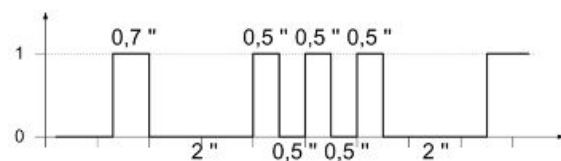

## Tachometer

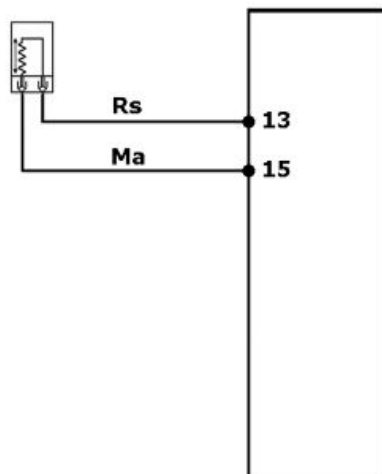

With wiring disconnected from the control unit and connected to the system, check that the sensor resistance between pins 13 - 15 is between 100 and 150 Ohm at an engine temperature of approximately 20°

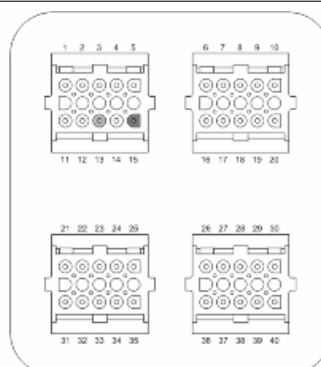

Disconnect the fuel pipe connector. Start up the engine and wait for it to stop. With the wiring connected to the control unit and system try to start up the engine and check that the voltage between pins 13 and 15 is around 2.8 V

With the interface cable harness disconnected from the control unit, check continuity between pin 13 and the red cable of the rpm sensor connector and between pin 15 and the brown cable of the rpm sensor connector

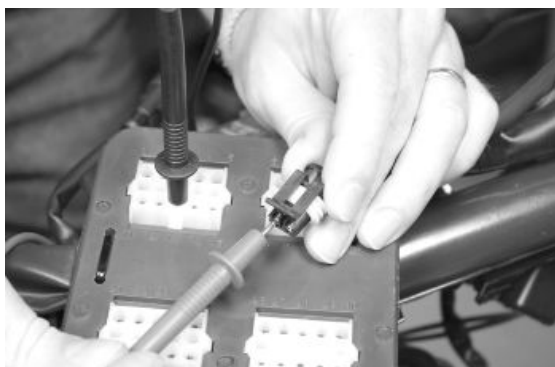

With the interface cable harness disconnected from the control unit and the rpm sensor connector disconnected, check that the red and brown cables (pin 13 - 15) are isolated from each other and insulated from the ground lead.

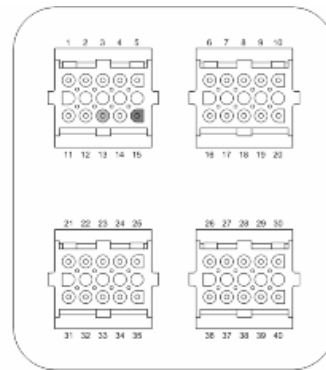

**Specific tooling**

**020481Y Control unit interface wiring**

**020331Y Digital multimeter**

**HT coil**

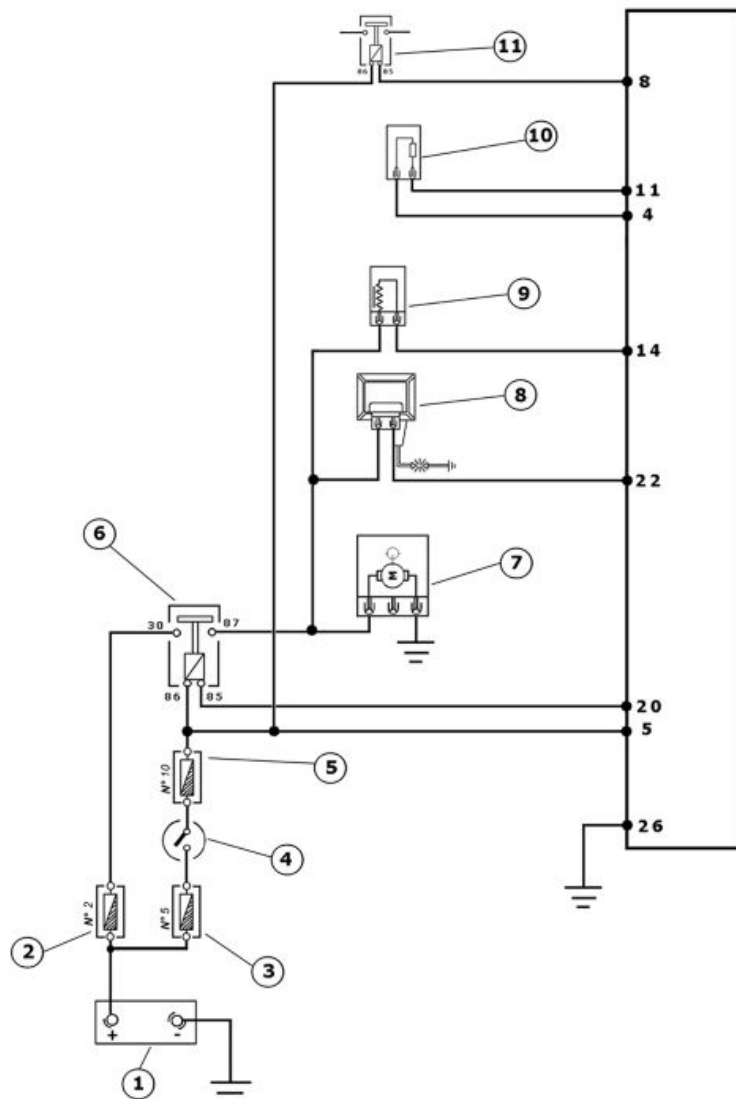

**INJECTION LOADS**

	<b>Specification</b>	<b>Desc./Quantity</b>
1	Battery	12V - 12 Ah
2	Fuse	15A
3	Fuse	20A
4	Key switch contacts	
5	Fuse	7.5 A
6	Injection load remote control	
7	Fuel pump	
8	HV coil	
9	Fuel injector	
10	Lambda sensor	
11	Electric fan starter	

The ignition system combined with the injection is the high-efficiency induction type.

The control unit controls two important parameters:

- Ignition advance

This is optimised from moment to moment in accordance with the engine revs, engine load, temperature and environmental pressure.

With the engine at idle, the ignition advance is optimised to stabilise the speed at  $1500 \pm 100$  rpms.

- Magnetisation time

The coil magnetisation time is controlled by the control unit. The power of the ignition is increased during the engine start-up phase.

The injection system recognises the four-stroke cycle so the ignition is only commanded in the compression phase.

**Specific tooling****020331Y Digital multimeter**

Check that the injection load 15A fuse No. 2 works properly.

Check that the live control unit power supply 7.5A fuse No. 10 works properly.

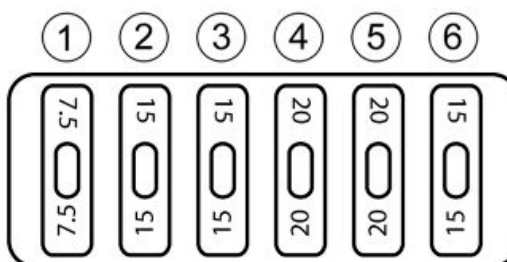



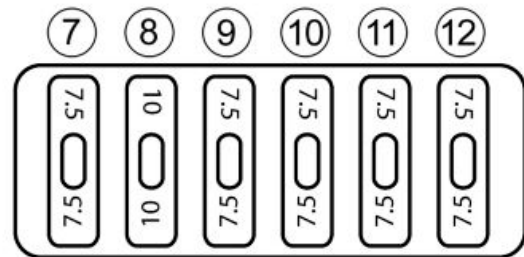

Check the efficiency of the injection load remote control: Check the resistance of the energising coil between pins 86 and 85: 40 to 80 Ohm  
Apply a voltage of 12V to pins 86 and 85; make sure that there is continuity between pins 30 and 87 of the remote control.

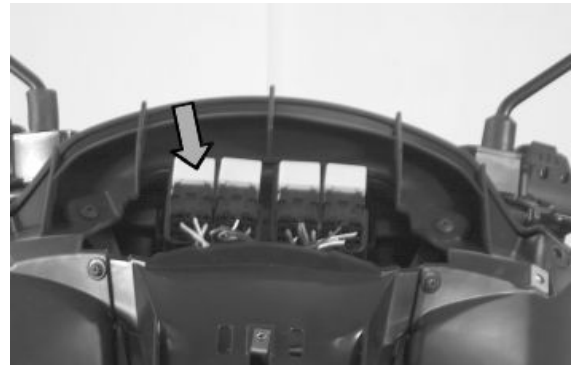

Check the power supply line of the injection load remote control energising coil: after switching to "ON", make sure there is battery voltage, for two seconds, between the Red-White cable and Black-Violet cable of the remote control base. If there is not, check the continuity of the Red-White cable between the fuse box and the remote control base and of the Black-Purple cable between the pin 20 of the control unit and the remote control base.

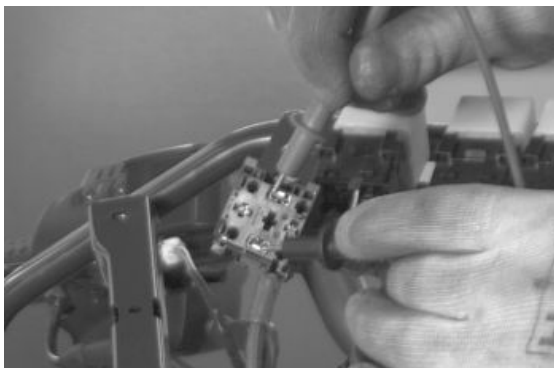

**N.B.**

**CONTINUITY TESTS MUST BE CARRIED OUT WITH THE COMPONENTS DISCONNECTED. (REMOTE CONTROLS, CONTROL UNIT, FUSES ETC.).**

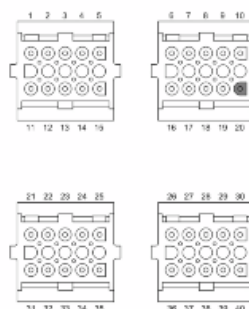

Check the presence of fixed voltage between the grey/black cable of the remote control base and earth. If there is none check the continuity of the grey/black cable between the fuse box (No. 2 15 A) and the remote control base.

**N.B.**

**CONTINUITY TESTS MUST BE CARRIED OUT WITH THE COMPONENTS DISCONNECTED. (REMOTE CONTROLS, CONTROL UNIT, FUSES ETC.).**





Check there is voltage between pins 22 and 26 of the interface wiring for around two seconds when switching to «ON»

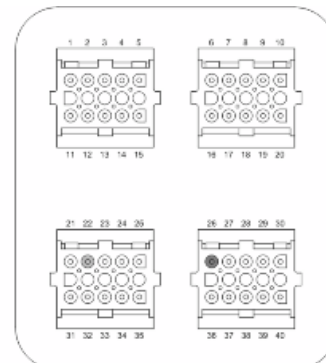

Check the resistance of the primary coil between pin 22 of the interface wiring and the green black cable of the injection load remote control base with the control unit disconnected and the remote control disconnected.

Primary resistance ~ 1 Ohm

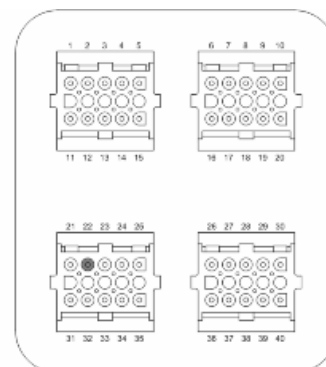



---

## Inspecting the spark plug shielded cap

Measure the shielded cap resistance.

### Electric characteristic

#### Resistance:

5 K $\Omega$

If different values are measured (<1; >20K $\Omega$ ), replace the shielded cap.

**N.B.**

**A SHIELDLESS CAP OR SPARK PLUG CAN AFFECT THE INJECTION SYSTEM.  
FOR INFORMATION ON THE SPARK PLUG, SEE THE «SPECIFICATIONS» AND «MAINTENANCE» CHAPTERS.**

---

## Spark advance

The ignition advance is determined electronically on the basis of parameters known by the control unit. For this reason it is not possible to declare the reference values based on the engine rpm.

The ignition timing value is detectable any time using the diagnostic tester.

It is possible to check whether the ignition advance determined by the system does in fact correspond with the value actually activated on the engine, by means of the stroboscopic light.

### Specific tooling

**020460Y Scooter diagnosis and tester**

**020330Y Stroboscopic light for timing control**

Proceed as follows:

- Remove the transmission compartment cover as described in the "automatic transmission" chapter.



- Remove the TDC reference inspection cap between flywheel and crankcase cover. See the "flywheel cover" chapter

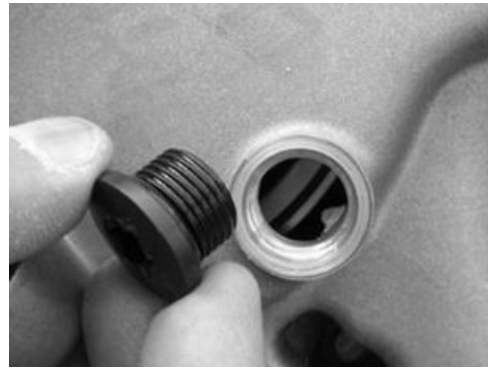

- By the driving pulley, turn the engine to find the alignment of the references to identify the TDC.



- Repeat for the reference between driving pulley and engine crankcase.



- Replace the inspection cap on the flywheel side.
- Connect the diagnostic tester.
- Start the engine.
- Select the menu on the "parameter" function.
- Select the stroboscopic light command in the traditional four-stroke engine position (1 spark 2 revs).
- Check that the real values of rpm and ignition advance match those measured using the diagnostic tester.



**If the values do not match, check:**

- distribution timing
- revolution-timing sensor

- Injection control unit

**Coolant temperature sensor**

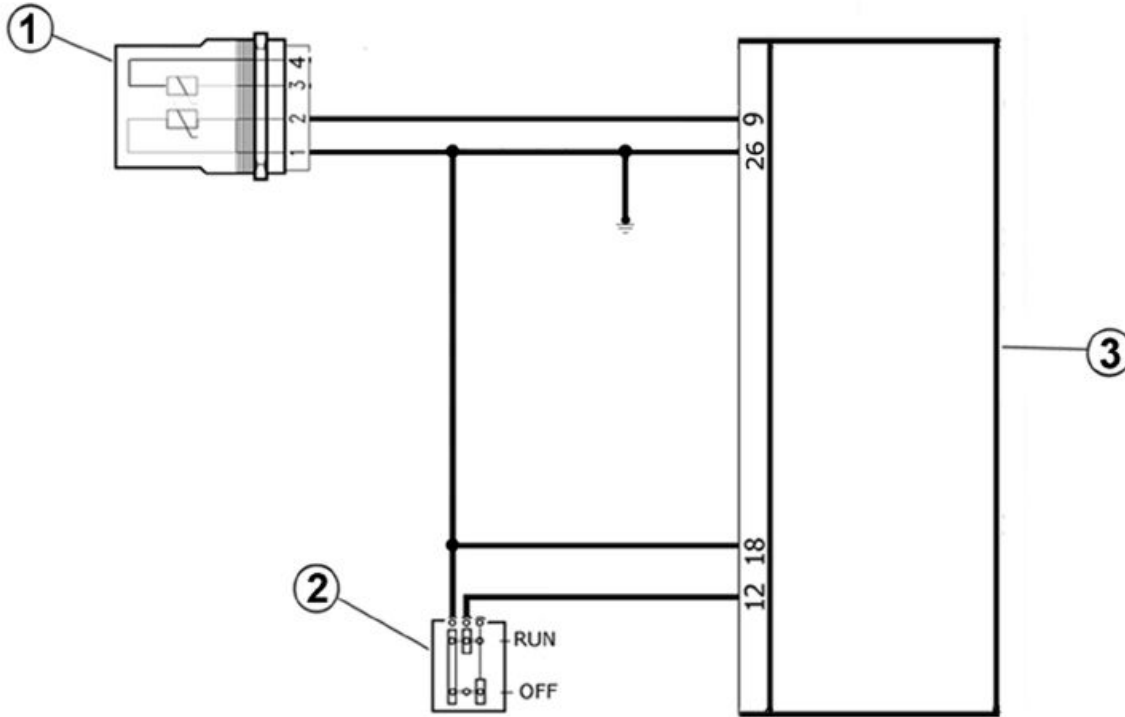

**TEMPERATURE SENSOR**

	Specification	Desc./Quantity
1	Water temperature sensor	
2	Engine stop switch	
3	Electronic control unit	

With the control unit side connector disconnected and the coolant temperature sensor connector connected, check that the resistance values between pin 9 and ground correspond to the engine temperature.

20° = 2500 ± 100 Ω

80° = 308 ± 6 Ω

With the control unit side connector disconnected and the coolant temperature connector disconnected, check the insulation between the light blue/green cable and ground.

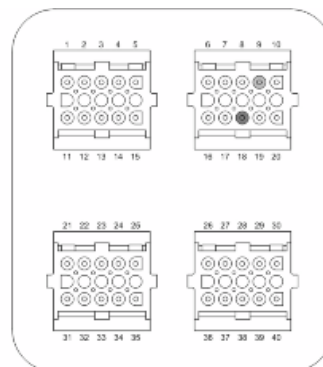

With the control unit side connector disconnected and the coolant temperature connector disconnected, check the continuity between pin 9 of the interface wiring harness and the light blue/green cable of the connector.



### Specific tooling

**020481Y Control unit interface wiring**

**020331Y Digital multimeter**

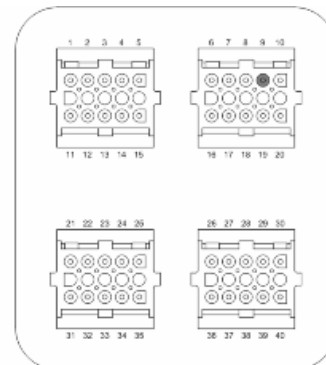

## Zeroing the throttle

### Resetting the throttle valve position signal (TPS reset)

The MIU control unit is supplied with throttle valve position sensor and is pre-calibrated.

Pre-calibration entails regulating the minimum opening of the throttle valve to obtain a certain flow of air under pre-set reference conditions.

Pre-calibration ensures optimal air flow for the control of the idling.

**This regulation must not be tampered with in any way whatsoever.**

The injection system will complete the management of the idling through the Stepper and the variation of the ignition advance.

The throttle body after the pre-calibration has an opened valve with angle that can vary depending on the tolerances of the machining of the pipe and the valve itself.

The valve position sensor can also assume various fitting positions. For these reasons the mVs of the sensor with the valve at minimum can vary from one throttle body to another.

To obtain the optimum fuel preparation, especially at small openings of the throttle valve, it is essential to match the throttle body with the control unit following the procedure known as TPS resetting.

With this operation we inform the control unit, as the starting point, of the mV value corresponding to the pre-calibrated position.

To reset, proceed as follows.

Connect the diagnostic tester.

Turn to "ON".

Select the functions of the diagnostic tester on "TPS RESET".

### Specific tooling

020460Y Scooter diagnosis and tester



Make sure that the throttle valve is supporting the stop screw.

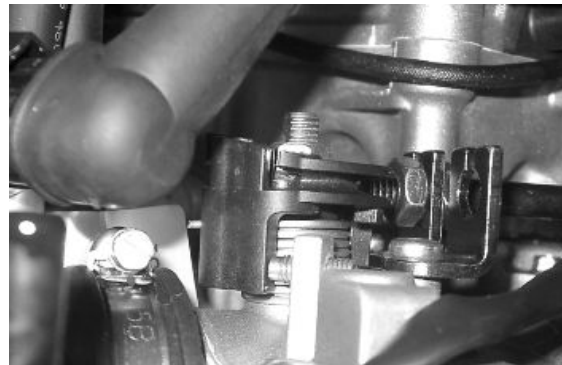

Guaranteeing that this position will be kept, give the confirmation for the TPS reset procedure.







Reset should be performed in the following cases:

- on first fitting.
- if the injection control unit is replaced.

**N.B.**

**THE TPS RESETTING POSITION MUST NOT BE CARRIED OUT WITH A USED THROTTLE BODY BECAUSE POSSIBLE VALVE WEAR AND STOP WEAR FOR THE MINIMUM OPENING MAKE THE AIR FLOW DIFFERENT FROM THAT OF PRE-CALIBRATION.**

---

Lambda probe

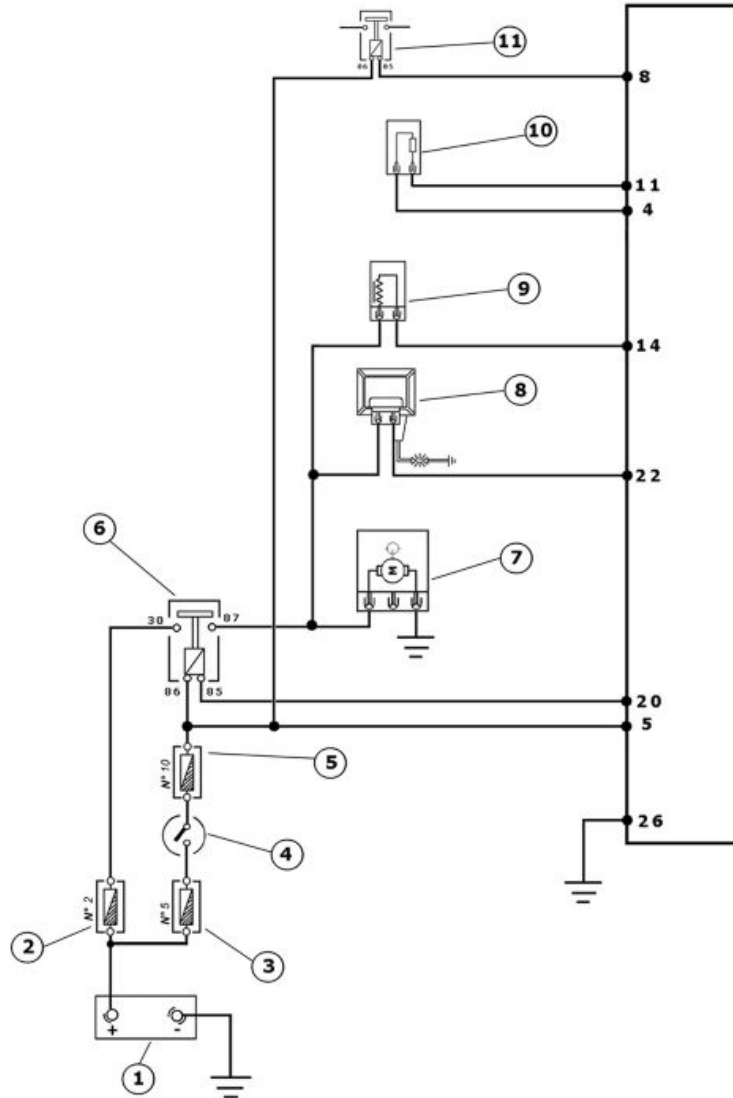

**INJECTION LOADS**

	<b>Specification</b>	<b>Desc./Quantity</b>
1	Battery	12V - 12 Ah
2	Fuse	15A
3	Fuse	20A
4	Key switch contacts	
5	Fuse	7.5 A
6	Injection load remote control	
7	Fuel pump	
8	HV coil	
9	Fuel injector	
10	Lambda sensor	

Specification	Desc./Quantity
11	Electric fan starter

The Lambda sensor or oxygen sensor is a sensor which provides indications concerning the oxygen content in the exhaust gas. The signal generated is not of the proportional type but of the ON/OFF type, i.e. there is oxygen or there is not. The sensor is positioned on the exhaust manifold before the catalytic converter in an area where the gas temperature is always high. The temperature at which the sensor works is at least 350°C at 600°C and it has a reaction time of just 50 milliseconds. The signal generated passes from a high value to a low value with a mixture with lambda =1.

**Specific tooling**

**020481Y Control unit interface wiring**

**020331Y Digital multimeter**

Check that the injection load 15A fuse No. 2 works properly.

Check that the live control unit power supply 7.5A fuse No. 10 works properly.

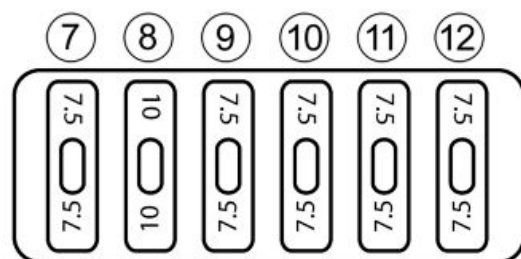
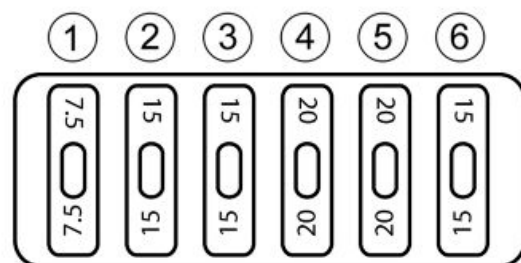

Check the efficiency of the injection load remote control: Check the resistance of the energising coil between pins 86 and 85: 40 to 80 Ohm  
Apply a voltage of 12V to pins 86 and 85; make sure that there is continuity between pins 30 and 87 of the remote control.

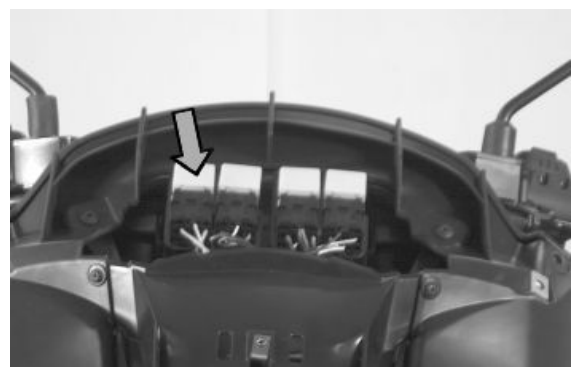



Check the power supply line of the injection load remote control energising coil: after switching to "ON", make sure there is battery voltage, for two seconds, between the Red-White cable and Black-Violet cable of the remote control base. If there is not, check the continuity of the Red-White cable between the fuse box and the remote control base and of the Black-Purple cable between the pin 20 of the control unit and the remote control base.

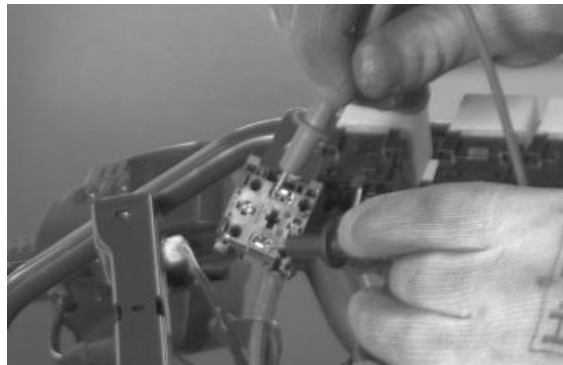

**N.B.**

**CONTINUITY TESTS MUST BE CARRIED OUT WITH THE COMPONENTS DISCONNECTED. (REMOTE CONTROLS, CONTROL UNIT, FUSES ETC.).**



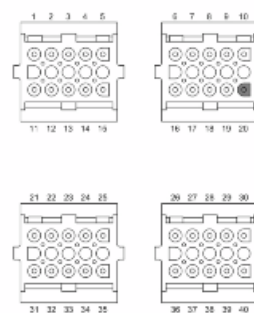

Install the electronic control unit interface wiring.  
 Start the engine and warm up until the electric fan switches on.  
 Use an analogue multimeter with a direct voltage scale measuring down to 2 V.  
 Place the tips of the multimeter between pins 4 (-) and 11 (+)

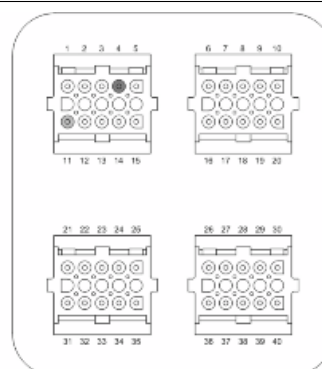

With the engine running at idle speed, check that the voltage oscillates between 0V and 1V  
 With the throttle valve completely open, the voltage is approx. 1V.  
 During the closing phase, the voltage is approx. 0V.  
 If the voltage remains constant, the sensor may be damaged. Remove the sensor and check that there are no oil or carbon deposits inside it..





## INDEX OF TOPICS

**SUSPENSIONS**

**SUSP**

---

This section is devoted to operations that can be carried out on the suspension.

---

## Front

---

### Removing the front wheel

---

- Remove the 5 fixing screws indicated in the photograph.

**Locking torques (N\*m)**

**Wheel fixing screw 20 ÷ 25**



### Front wheel hub overhaul

---

- Remove the ball bearing seeger ring indicated in the photograph



Extract the ball bearing using the specific tool

#### **Specific tooling**

**001467Y014 Extraction pliers for ø 15 mm bearings**

**001467Y017 Bell for bearings, outside Ø 39 mm**





- Remove the oil seal on the roller bearing side using a screwdriver.



- Remove the roller bearing using the specific tool

### Specific tooling

**020376Y Adaptor handle**

**020456Y Ø 24 mm adaptor**

**020363Y 20 mm guide**



- Heat the roller bearing seat with a heat gun
- Use the specific tool to introduce and push the bearing until it stops, with the shielded side facing out
- Refit the ball bearing locking seeger ring

### Specific tooling

**020151Y Air heater**

**020376Y Adaptor handle**

**020359Y 42 x 47 mm adaptor**

**020412Y 15 mm guide**



- Use the specific tool to fit and push the roller casing until it stops
- Refit the oil seal on the roller bearing side
- Lubricate the area between the roller bearing and the ball bearing

### Specific tooling

**020038Y Punch**

### Recommended products

**AGIP GREASE MU3 Grease for odometer transmission gear case**



---

Soap-based lithium grease with NLGI 3; ISO-L-XBCHA3, DIN K3K-20

---

## Handlebar

---

### Removal



- Remove the three handlebar covers working as explained in the Bodywork Chapter.
- Remove the handlebar wiring retaining straps and disconnect the electric connectors from the brake levers.
- Unscrew the fittings, then remove the front and rear brake pump piping.
- Remove the flexible transmission of the throttle grip and remove the throttle.
- Loosen the clamp fixing the handlebar to the steering tube and remove the handlebar by pulling it upwards.

**N.B.**

**IF THE HANDLEBAR IS BEING REMOVED TO REMOVE THE STEERING, IT IS ONLY NECESSARY TO TILT THE HANDLEBAR FORWARD ONTO THE FRONT PART OF THE VEHICLE WITHOUT REMOVING THE PARTS FITTED SO AS TO AVOID DAMAGING THE SHAFTS.**

---

### Refitting

Carry out the above operations by working in the reverse order from those of the removal.

#### Locking torques (N\*m)

Handlebar fixing screw 50 ÷ 55

---

### The tilt mechanism

---

## Hydraulic system layout

When tilting is locked, the geared motor activates the hydraulic pump indicated in the photograph and pressurises the circuit.

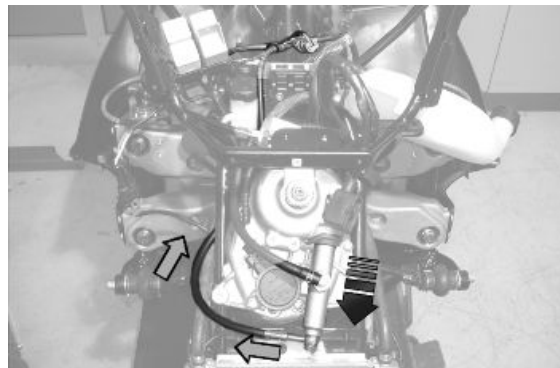

The pressurised oil reaches the distribution frame «T» and the pressure sensor «A». Then, the pipes branch out to reach the upper joints on the side steering tubes.

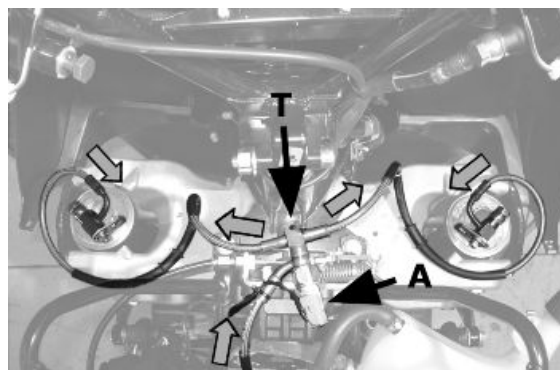

Through the rigid-flexible pipes inside the side steering tubes, the oil reaches the stem sliding locking device placed parallel to the shock absorber.



## Steering tubes

Remove the brake calliper pipe retainers and the hydraulic pipe fitting from the brake calliper making sure there is a container to collect the brake fluid.

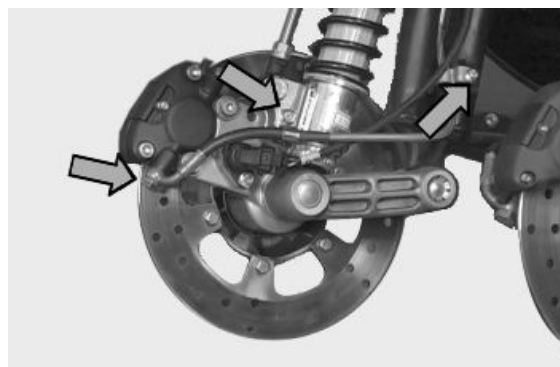

Disconnect the tone wheel connector indicated in the photograph.

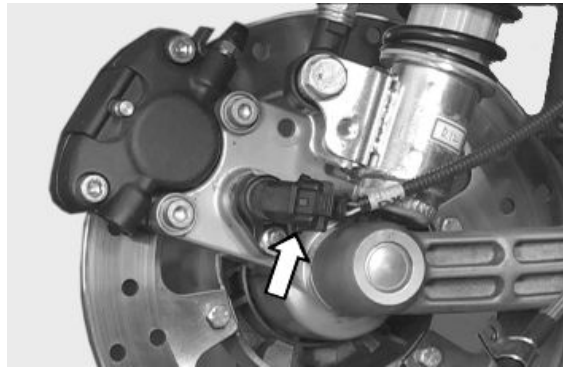

Remove the hydraulic pipe fitting from the sliding locking device, making sure again that the liquid drained is collected.

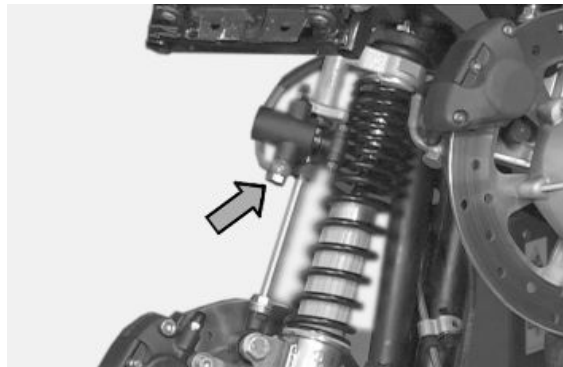

Remove the upper fittings, on the parallelogram, of the brake hydraulic pipes and the suspension lock indicated in the photograph.

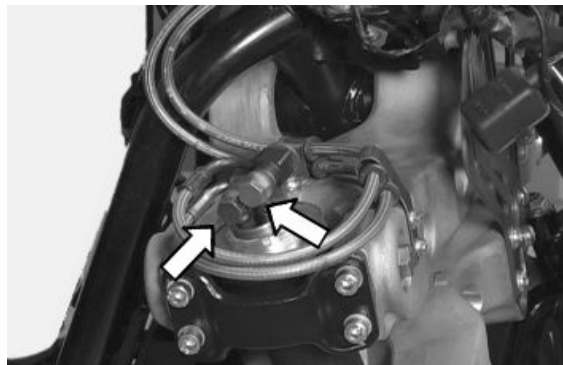

Remove the hydraulic pipe fitting fixing nuts indicated in the figure from the support bracket.



Remove the suspension tilt locking device pipes from the headstock.

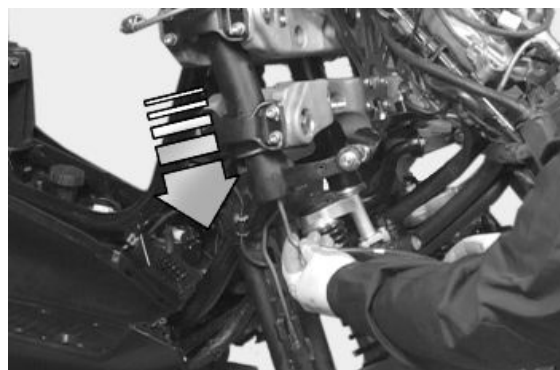

Remove first the flexible part of the calliper from the steering tube as shown in the photograph, and then remove the rigid part.

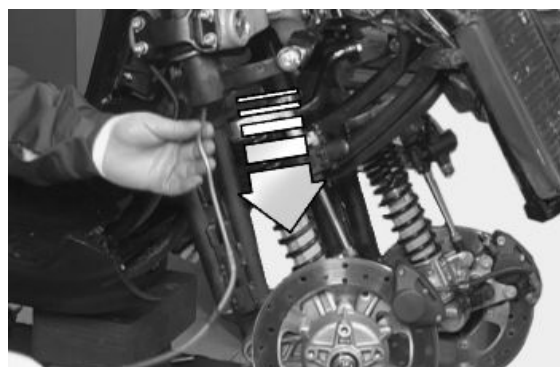

Remove the tone wheel wiring by disconnecting the connector on the fuel tank after removing the chassis central cover.

After that, remove the retainers indicated in the figure.

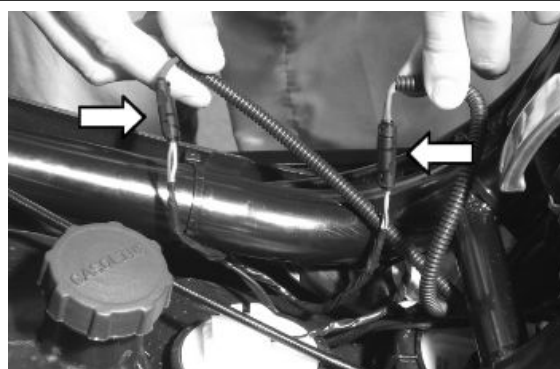

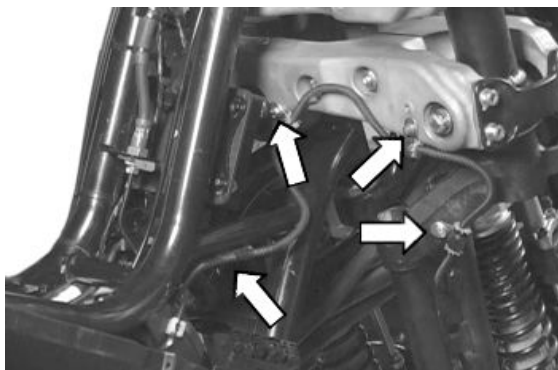

Remove the constant-velocity universal joint from the steering bar by undoing the nut indicated in the photograph.



Use a specific tool to remove the upper tightening ring nut of the steering tube.

**Specific tooling**

**020055Y Wrench for steering tube ring nut**

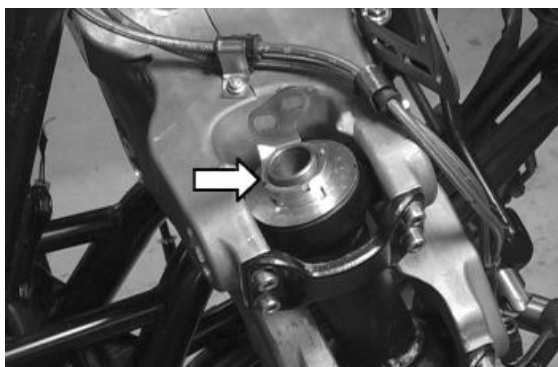

Remove the hydraulic pipe support bracket.

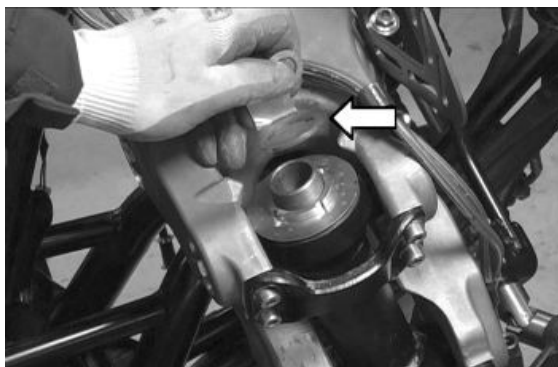

Remove the steering tube lower ring nut and the protection cap indicated in the photograph.

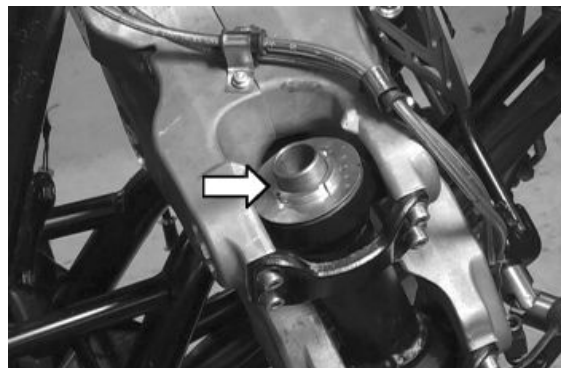

Now, it is possible to remove the steering tube.



Check that the roller tapered bearing does not show signs of abnormal wear. If it is, replace it.



**THE OPERATIONS DESCRIBED BELOW CAN ALSO BE CARRIED OUT EVEN WHEN THE SUSPENSION IS FITTED**

Remove the lower retainer of the sliding stem shown in the photograph.

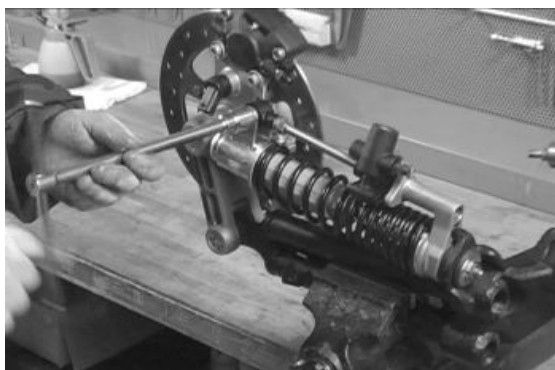

Remove the sliding stem locking device retainers indicated in the photograph.

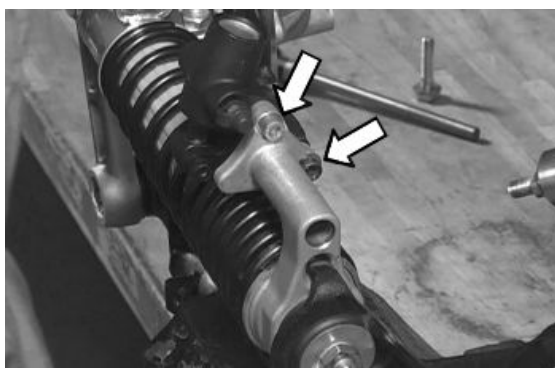

Check that the sliding stem locking device does not show signs of abnormal wear.

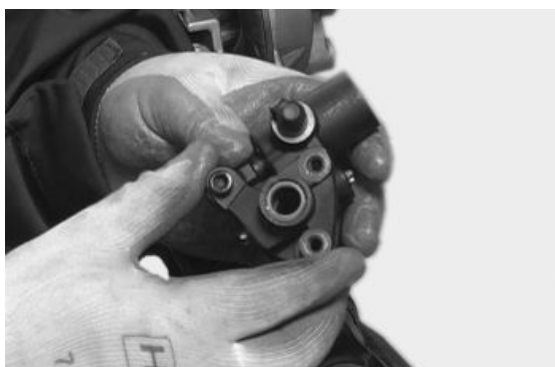



For refitting, follow the operations for removal but in reverse order, observing the prescribed torques and greasing the bearings and their seats.

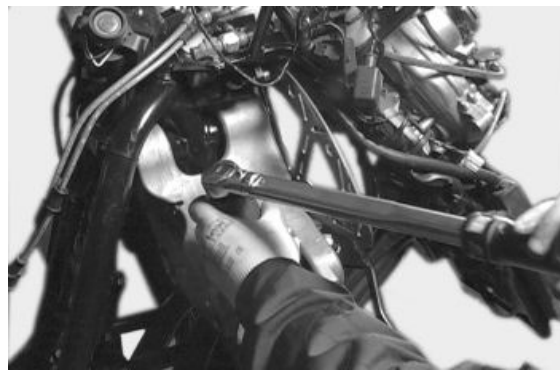

#### STEERING TUBES

Name	Torque in Nm
Side headstock upper ring nut	20 - 24
Side headstock lower ring nut	12 ÷ 15
Screw fixing sliding stem to shock absorber	45 ÷ 50
Clamp for sliding stem locking device	6.5 ÷ 10.5
Fixing nuts for constant-velocity universal joints	18 ÷ 20

### Parallelogram device

Remove the steering tubes.

To facilitate removal operations of the brake disc sector, loosen the 3 fixing screws in the hydraulic electro-actuator indicated in the photograph.

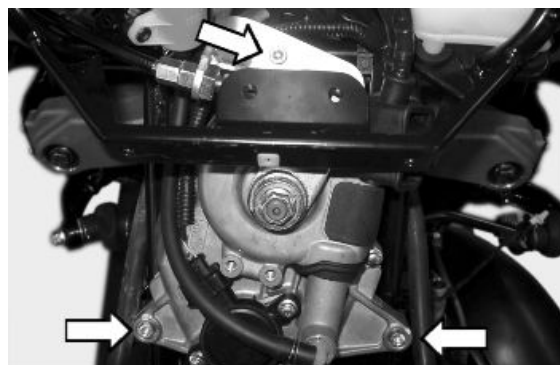

Remove the hydraulic pipe retainers from the parallelogram.





Remove the 4 screws fixing the tilt brake disc sector indicated in the photograph.

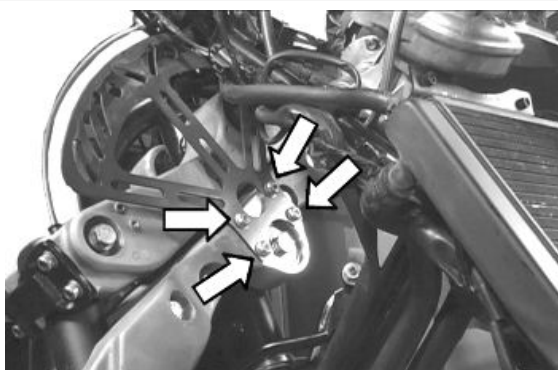

Remove the retainers indicated in photograph of the half-arms joint flange.

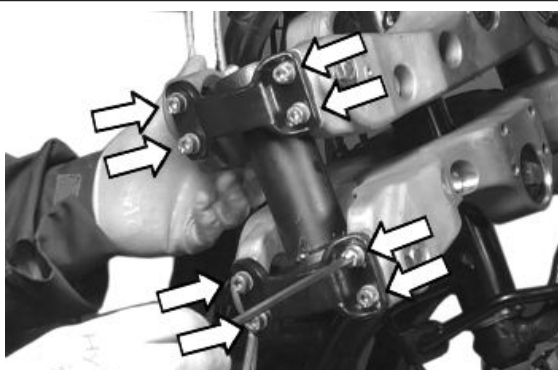

To facilitate the operations indicated below, remove the suspension locking electronic control unit indicated in the photograph.

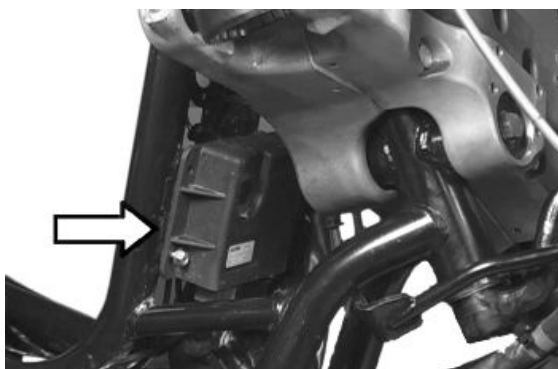

Remove the arm coupling retainers from the parallelogram by loosening the retainers indicated. For easy refitting operations, remember to take note of the positions of the components.

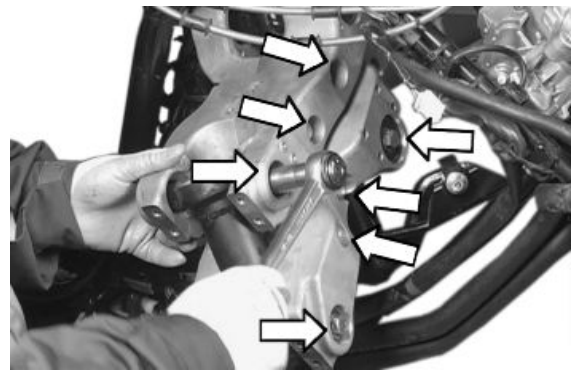

Separate the half-arms by hitting slightly with a wooden mallet where possible alternatively to the left and right side of the parallelogram.

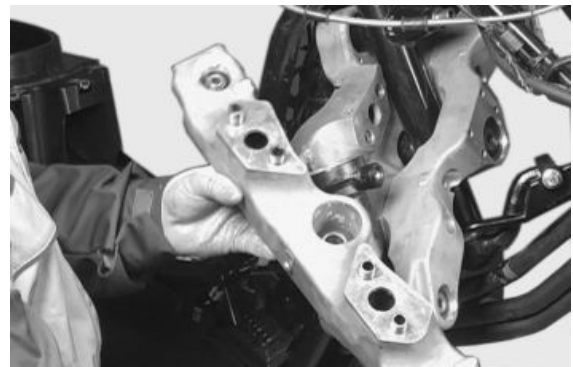

Remove the headstocks.



Carry out a visual check of the upper and lower bearings on the headstocks and their seats. Replace them in case of signs of abnormal wear.

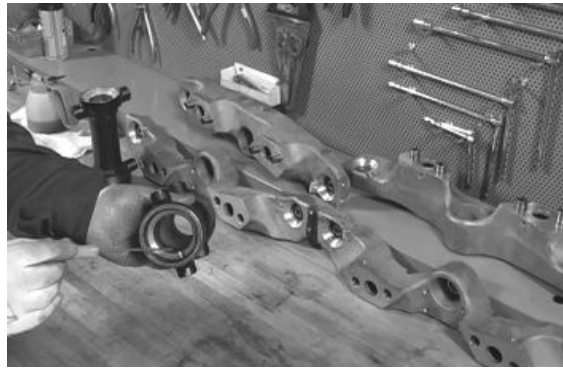

Check the ball bearings on the parallelogram arms. Replace them in case of signs of abnormal wear.



Check the inside tracks of the parallelogram bearings on the chassis.



For refitting, follow the operations for removal but in reverse order, lubricating the locking pins on the parallelogram half-arms and observing the prescribed torques.



#### PARALLELOGRAM DEVICE

Name	Torque in Nm
Arm coupling screws	45 ÷ 50
Screws fixing arms to side headstocks	45 ÷ 50
Screws fixing arms to central headstock	45 ÷ 50
Screws fixing the half-arm coupling flange	20 ÷ 25

Name	Torque in Nm
Fixing screws for tilt locking disc section	20 ÷ 25

### Geared motor and Suspension locking system

Select the SYSTEM RESET option from the main menu



Turn the key switch to ON  
 Select the LOWER STOP SEARCH option from the SYSTEM RESET menu

WAIT

PROCEDURE IN PROGRESS

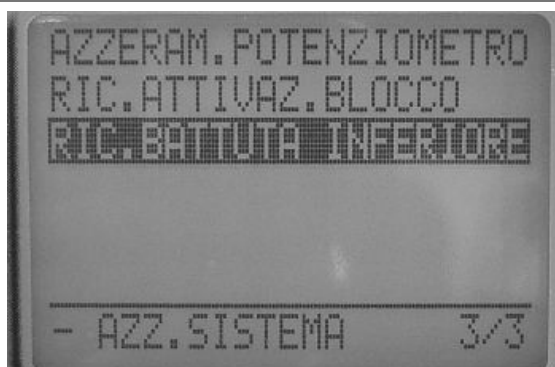

The hand-held computer indicates the outcome of the stop search operation:

POSSIBLE LIMIT STOP VALUES. TO EXIT, PRESS A KEY AND TURN OFF AND ON. SELECT PARAMETERS TO ADJUST AT 12°.

Check the geared motor if the hand-held computer does not indicate this.



Select the PARAMETERS option from the main menu

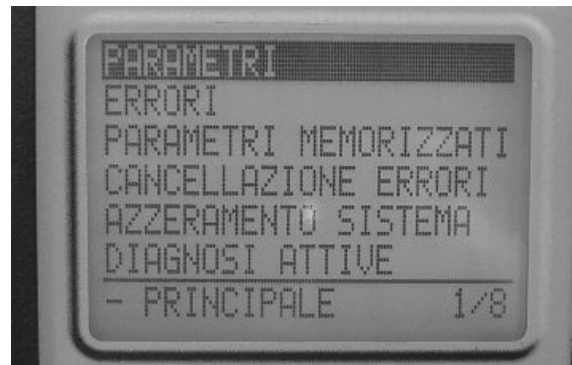

The hand-held computer displays the option: RELATIVE POTENTIOMETER ANGLE

This function is active coming from the LOWER STOP SEARCH procedure.

NOTE: a slight oscillation of the angle value between 0.00° and 0.50° is considered normal



Remove the protection cap of the geared motor set screw

Use a plain slot screwdriver to turn the set screw anticlockwise until replicating the 12° condition on the hand-held computer

RELATIVE POTENTIOMETER ANGLE 12° (a slight value oscillation is considered normal)

Refit the protection cap





Remove the protection cap, align the pump control and lock the screw to the prescribed torque

**Locking torques (N\*m)**

**Clamp fixing pump bolt to anti-tilting device 11 ÷ 13**



Select the SYSTEM RESET option from the MAIN menu

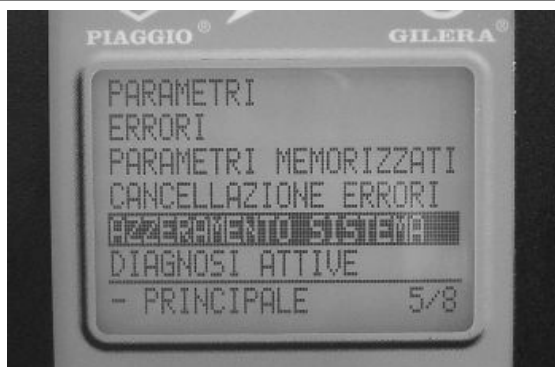



Select the POTENTIOMETER RESET option from the SYSTEM RESET menu and press OK.

WAIT....

PROCEDURE IN PROGRESS



The hand-held computer displays the words: CHECK THAT THE CONTROL IS SET AT 12° FROM THE LOWER STOP. PRESS OK TO CONTINUE

Press OK

The hand-held computer displays the words: POSSIBLE LIMIT STOP VALUES. PRESS A KEY AND SHIFT OFF AND ON



If this is not successful, the tilt locking mechanism remains locked for safety.

Adjust the flexible transmission so that a small clearance is left to guarantee switch activation on the tilt locking calliper

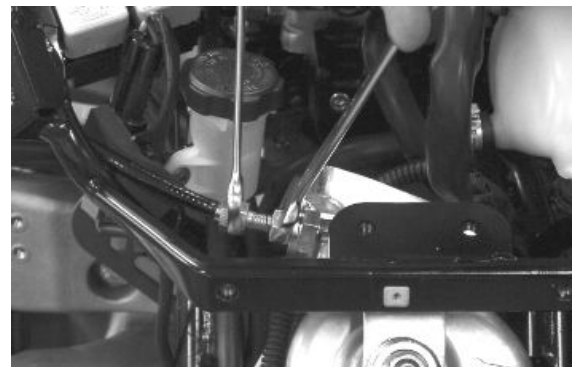

Remove the two bracket screws after releasing the spring and freeing the flexible transmission adjustment.

CAUTION: A FIRST PRODUCTION BATCH WILL BE EQUIPPED WITH DOUBLE COAXIAL SPRING.

It is very important to remove the flexible transmission from its fitting only for replacement.

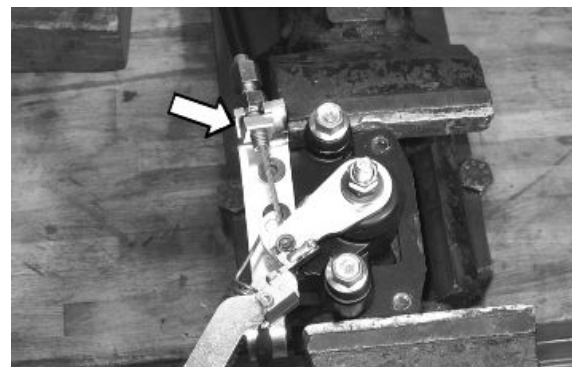

When refitting, tighten the two bracket screws and the flexible transmission lever nut to the prescribed torque.

**Locking torques (N\*m)**

**Bracket tightening screws 8 ÷ 12**

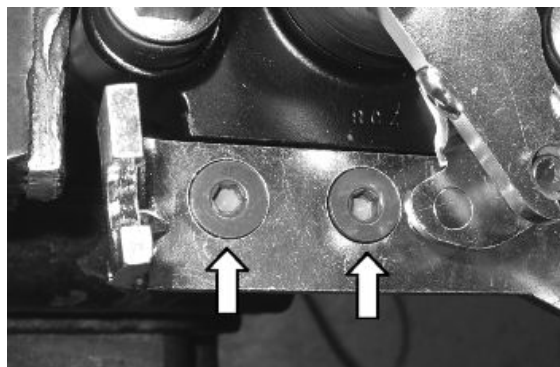
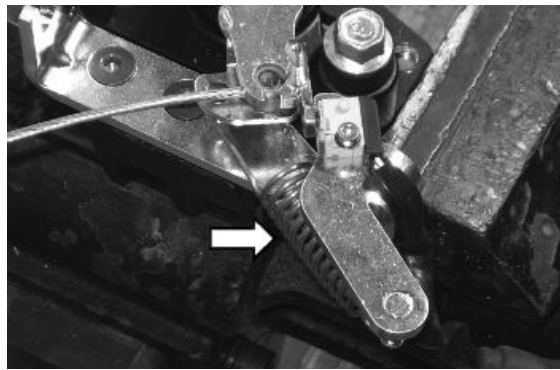

Unscrew the Allen screw and remove the switch. When refitting, place the switch with the button oriented to the stop indicated on the calliper lever; observing the reference indicated on the switch supporting bracket.

After refitting, check in detail that the switch is regularly activated by the stop on the lever.





Unscrew the two pad pin screws, remove the pads with the spring.

When refitting, tighten the two screws to the prescribed torque and use Threadlock.

When refitting, adjust the cable properly so that the switch is pushed when the system is unlocked.

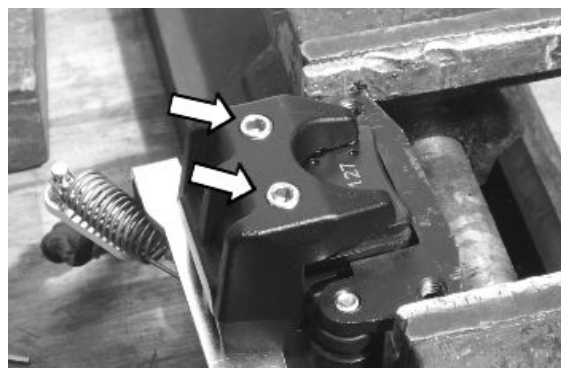

Refit the spring/toothed sector unit, hold the crankcase in a perfectly horizontal and stable position, place the spring/toothed sector unit keeping it perfectly perpendicular to the bearing already fitted on the crankcase; if necessary, slightly hit the unit shaft end with a mallet and protect the thread by screwing in a nut.

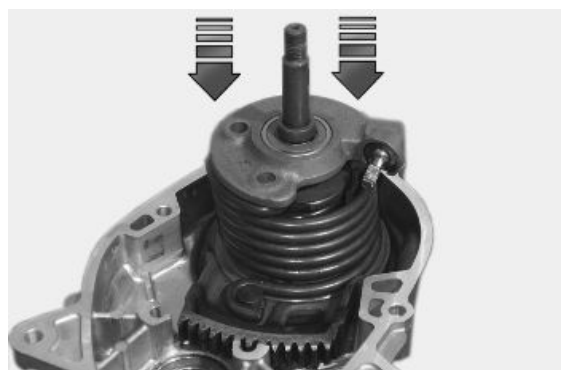

Fit the pinion and align the reference on the pinion teeth with the reference indicated on the second slot of the toothed sector.

Grease the pinion and the toothed sector with specific grease.

Refit the toothed sector spacer.

### Recommended products

**MONTBLANC MOLYBDENUM GREASE MON-TBLANC MOLYBDENUM GREASE**

Molybdenum disulphide grease

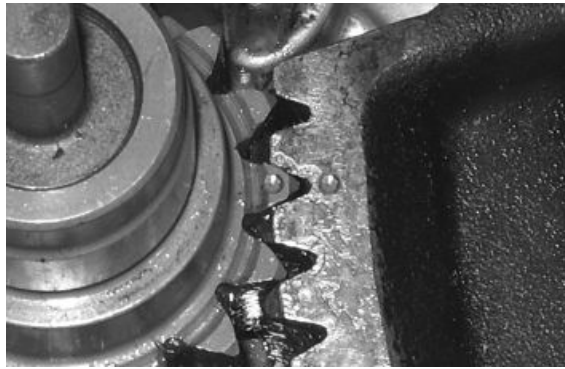

Lubricate the interference areas, match the crankcase halves with slight hits of a mallet to get them into contact.

Place the flexible transmission supporting bracket, refit the four screws, screw them to the prescribed torque.

### Locking torques (N\*m)

**Geared motor crankcase halves coupling screws 11 ÷ 13**

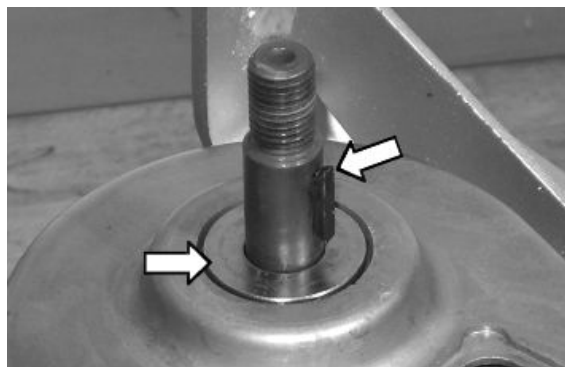

Refit the electric motor; check the position is correct by means of the reference indicated during removal.

The motor should be so positioned that it does not protrude from the reduction unit mould, see figure.

Tighten the screws to the prescribed torque.

### Locking torques (N\*m)

**Electric motor coupling screws 11 ÷ 13**



Place the moulded washer of the flexible transmission control lever shaft and the tongue.  
Refit the flexible transmission control lever as shown in the figure.



Refit the potentiometer (not forcing in the D-type connector ensures a sole position) with the connector directed to the opposite side of the hydraulic pump.

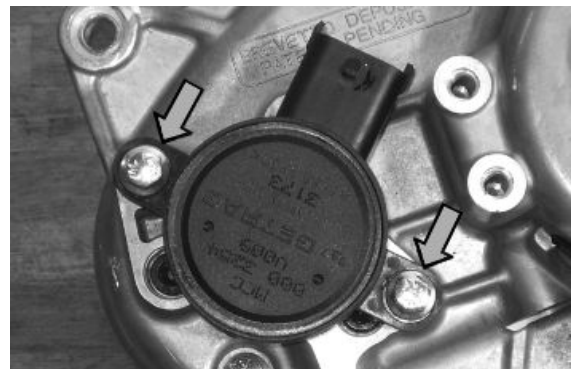

Refit the hydraulic pump on the geared motor body and tighten the screws to the prescribed torque.  
Fit but not tighten the pump stem coupling screw and refit the plastic protection cap.  
The synchronisation procedure should be complete when the installation is finished.

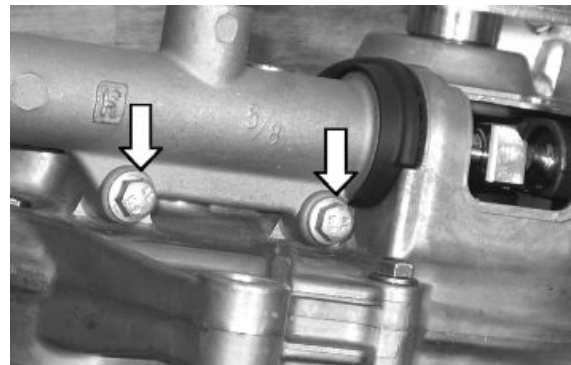

### Locking torques (N\*m)

**Geared motor hydraulic pump tightening screws 11 ÷ 13**

Remove the retaining seeger ring of the bearing of the flexible transmission lever control shaft bearing.

Remove the bearing with the specific tool.

### Specific tooling

**020376Y Adaptor handle**

**020441Y 26 x 28 mm adaptor**

**020362Y 12 mm guide**

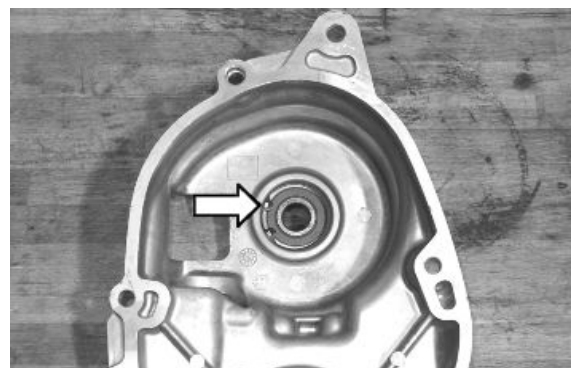

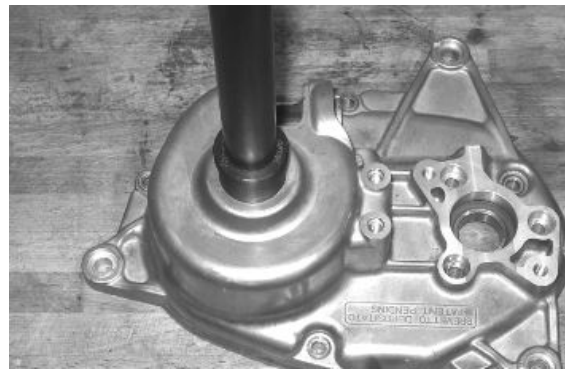

Extract the electric motor bearing with the specific tool.

### Specific tooling

**020376Y Adaptor handle**

**020375Y 28 x 30 mm adaptor**

**020363Y 20 mm guide**



Hold the crankcase in a perfectly horizontal position, heat it with a heat gun at a temperature of about 120 °C, use the specific tool to fit the bearing of the flexible transmission lever control shaft. Hit slightly with a mallet if necessary.

Refit the bearing check seeger ring.

### Specific tooling

**020151Y Air heater**

**020376Y Adaptor handle**

**020362Y 12 mm guide**

**020357Y 32 x 35 mm adaptor**



Hold the crankcase in a perfectly horizontal position, heat it with a heat gun at a temperature of about 120 °C, use the specific tool to fit the bearing of the electric motor. Hit slightly with a mallet if necessary.

### Specific tooling

**020363Y 20 mm guide**

**020358Y 37x40 mm adaptor**

**020151Y Air heater**



**020376Y Adaptor handle**

Remove the spring/toothed sector unit from its fitting, slightly hit with a mallet if necessary to release the unit.



Extract the bearing of the spring/toothed sector unit with the specific tool.

**Specific tooling**

**001467Y002 Driver for OD 73 mm bearing**



Extract the bearing of the electric motor with the specific tool.



Hold the crankcase in a perfectly horizontal position, heat it with a heat gun at a temperature of about 120 °C, use the specific tool to fit the bearing of the spring/toothed sector unit. Hit slightly with a mallet if necessary.

**Specific tooling**

**020360Y 52 x 55 mm adaptor**

**020151Y Air heater**

**020376Y Adaptor handle**

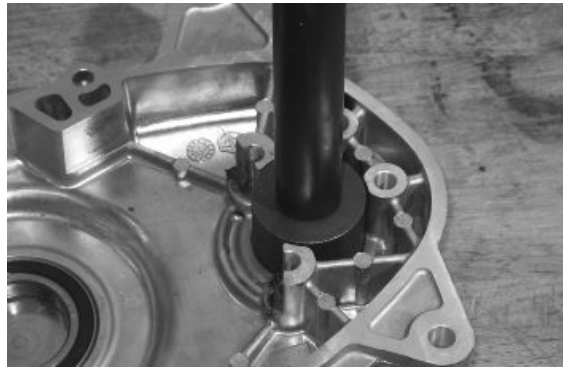

Hold the crankcase in a perfectly horizontal position, heat it with a specific heat gun at a temperature of about 120 °C, use the specific tool to fit the bearing of the electric motor. Hit slightly with a mallet if necessary.

**Specific tooling****020363Y 20 mm guide****020151Y Air heater****020376Y Adaptor handle****020477Y 37 mm adaptor**

Before removing the geared motor:

Disable the suspension lock.

- Remove the front shield.

With the set nut indicated in the photograph, remove the tensioning cable of the suspension locking mechanical calliper.

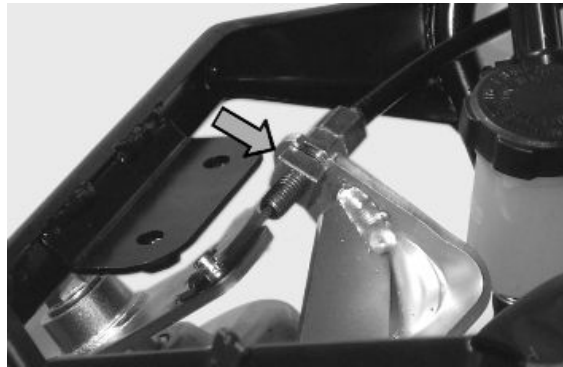

Remove the electrical connection of the geared motor position potentiometer.

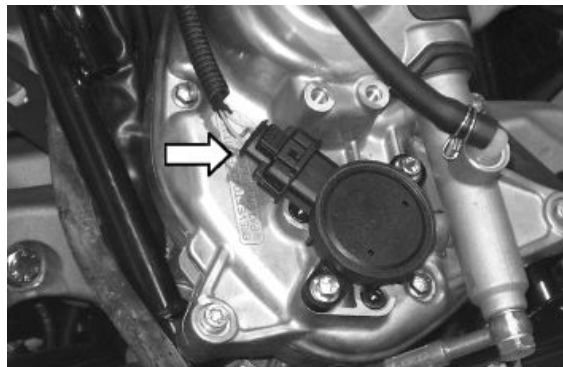

Remove the electrical connection of the geared motor electric motor.





Disconnect the hydraulic pipes between the pump and the sliding stem locking clamps. Empty the system and use a container to collect the brake fluid.

**CAUTION**

**ELIMINATE ANY REMAINING BRAKE FLUID SPILLS.**



**WARNING: BRAKE FLUID IS HIGHLY POISONOUS. DO NOT INGEST OR SWALLOW. IF ACCIDENTALLY SWALLOWED, DRINK LARGE QUANTITIES OF MILK OR WATER AND SEEK MEDICAL ADVICE IMMEDIATELY. BRAKE FLUID DESTROYS SKIN AND OCULAR TISSUE. IF YOU ACCIDENTALLY SPILL BRAKE FLUID ON YOURSELF, TAKE OFF YOUR CLOTHES, WASH WITH HOT WATER AND SOAP AND SEEK MEDICAL ADVICE IMMEDIATELY. IF BRAKE LIQUID GETS ACCIDENTALLY IN CONTACT WITH YOUR EYES, RINSE WITH ABUNDANT FRESH WATER AND SEEK MEDICAL ADVICE IMMEDIATELY. KEEP BRAKE FLUID OUT OF THE REACH OF CHILDREN.**



Remove the 3 fixing screws indicated and remove the whole geared motor.

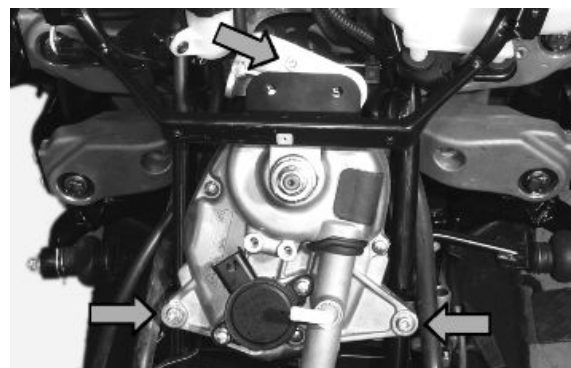

Use a screwdriver to remove the plastic access cover to the pump joint/geared motor  
 Unscrew the pump joint screw.  
 Unscrew the two geared motor pump locking screws.



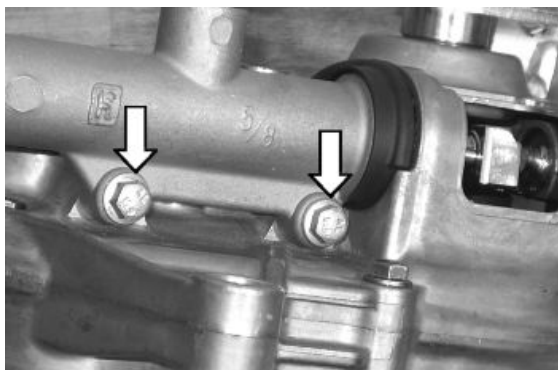

Unscrew the two potentiometer screws.  
When refitting, plug the potentiometer in D-type connector, afterwards place it with its electric connection directed to the opposite side of the pump.

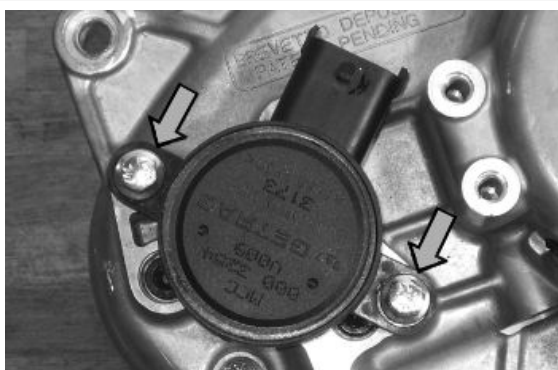

Remove the nut indicated in the figure, if necessary lock the lever with a vice making sure not to spoil the surface.  
In case of difficulties when removing the lever, use the specific tool.  
Remove the tongue and then, the moulded washer.



### Specific tooling

**020234y extractor**

Remove the three fixing screws of the electric motor.

It is important to mark the direction of the electric motor position in order to refit it correctly.

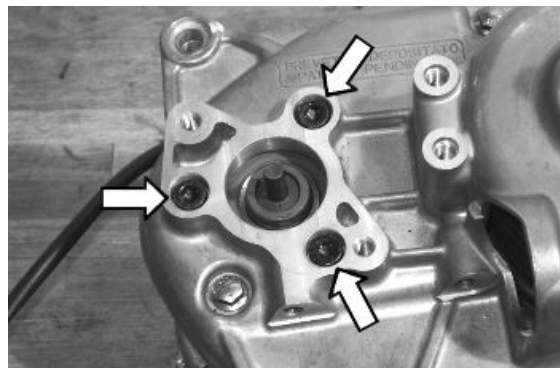

Remove the four screws indicated in the figure, remove the flexible transmission supporting bracket, separate the two crankcase halves, if necessary, use a rubber mallet to hit the flexible transmission lever in order to separate the two crankcases.

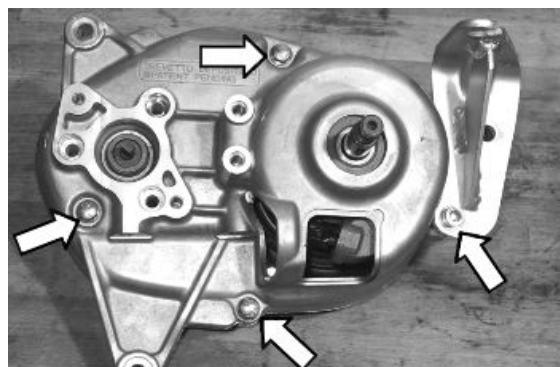

### Electrical devices test

PRESSURE SWITCH

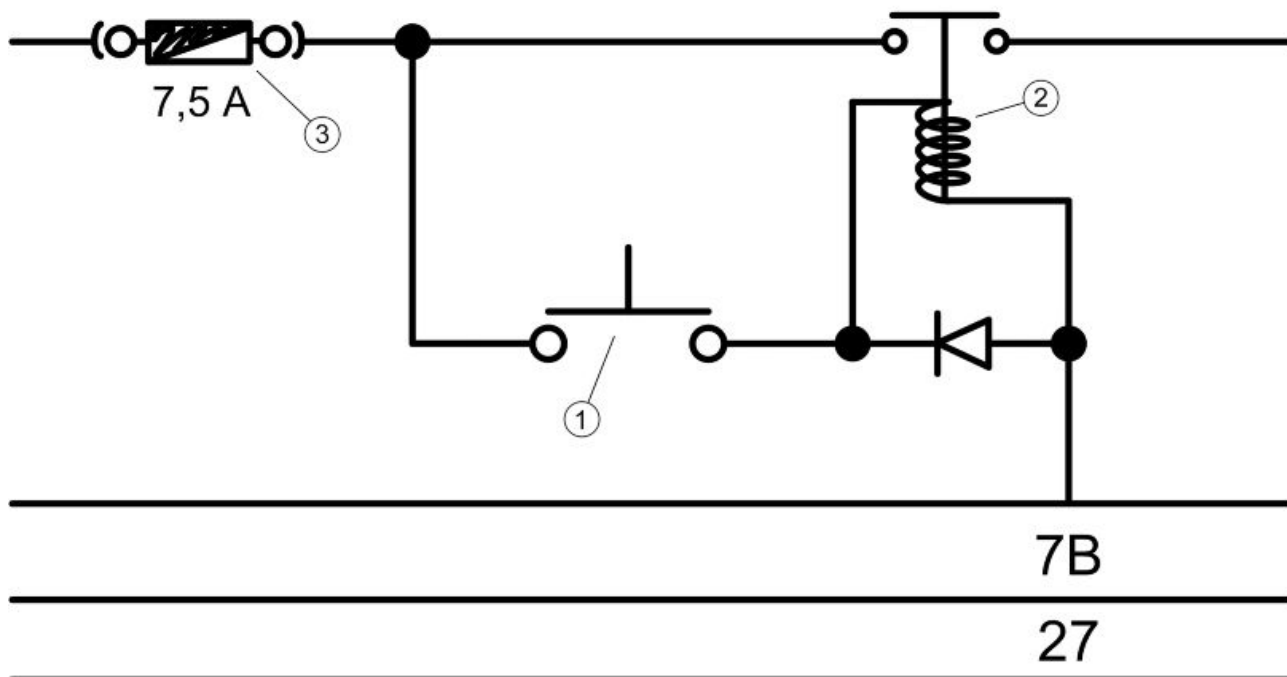

1: PRESSURE SWITCH

2: HORN REMOTE CONTROL

3: FUSE No. 11, 7.5A

Check 7.5 A fuse No. 11 for efficiency. With interface wiring disconnected from the control unit, check the continuity of the blue - black cable between pressure sensor connector and the horn remote control base as indicated in the photograph. Check the continuity between pin 27 and the remote control base white cable.

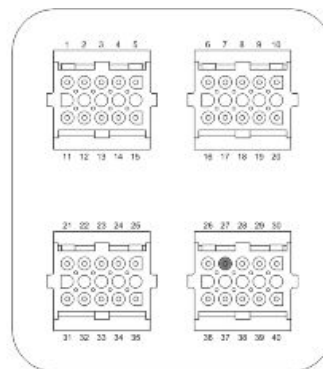

Check the continuity of the yellow-red cable between the pressure switch connector and the fuse box (7.5A fuse No. 11) and between the remote control base and the fuse box (7.5A fuse No. 11). With a multimeter, also check the pressure switch operation as well as the continuity at rest as this is normally closed switch.

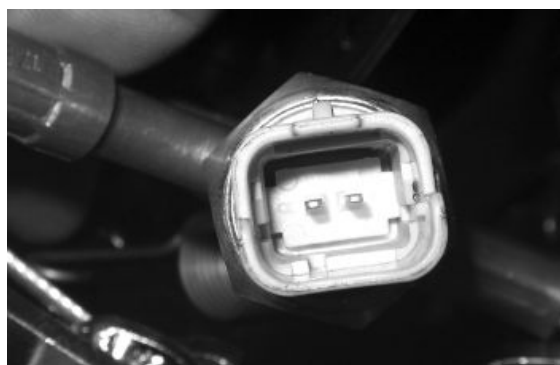
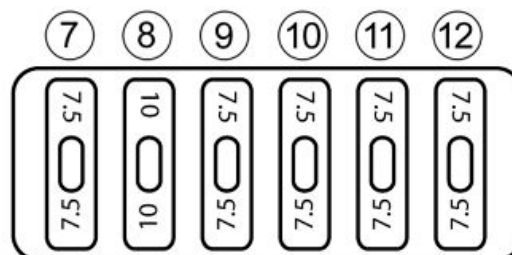

PRINCIPLE DIAGRAM FOR TILT LOCKING ELECTRICAL SYSTEM

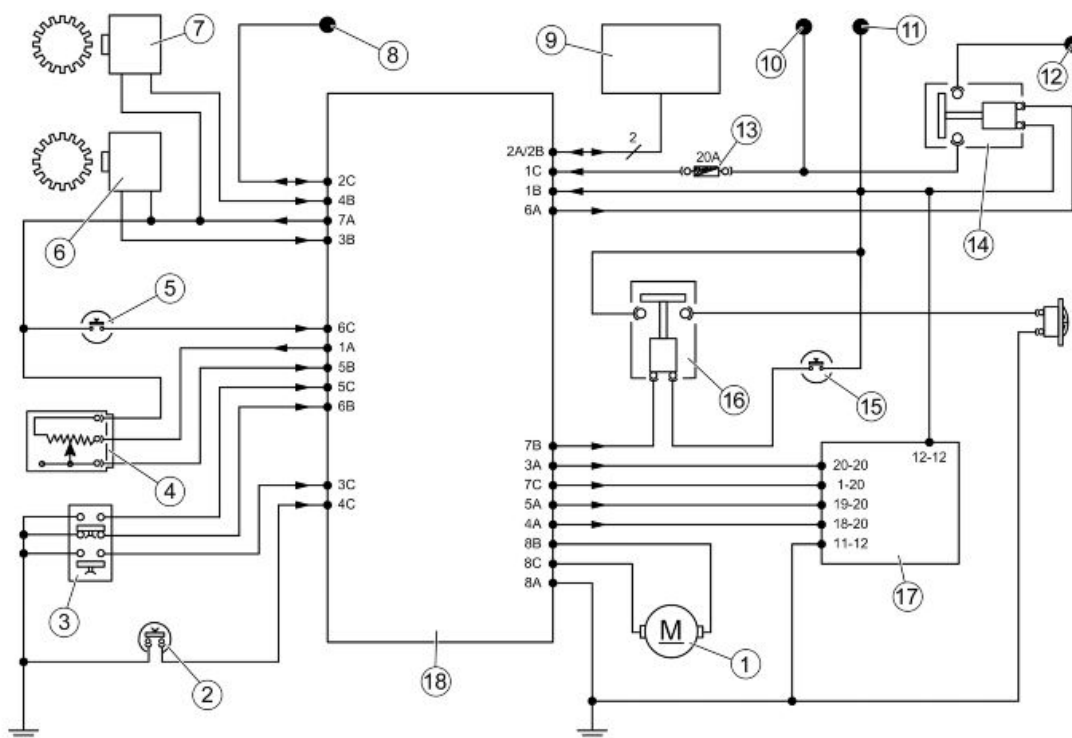

**KEY**

1. Geared motor
2. Brake calliper sensor
3. Tilt unlocking-locking control switch
4. Potentiometer
5. Rider presence sensor
6. Left speed sensor
7. Right speed sensor
8. Diagnostic tester serial line
9. Engine electronic control unit
10. Direct +Battery
11. Live +Battery
12. To light switch
13. 20A Fuse No. 4
14. Light remote control
15. Pressure switch
16. Horn remote control
17. Instrument panel
18. Tilt locking system control unit

**GEARED MOTOR**

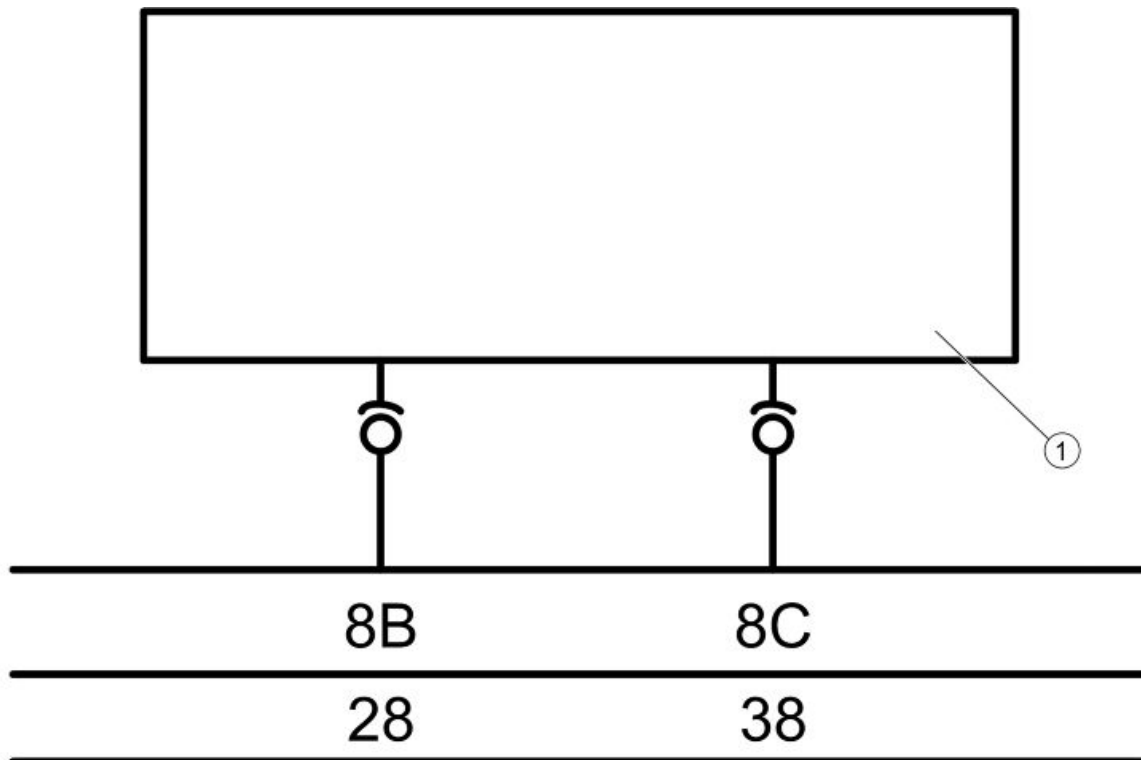

1: GEARED MOTOR



With the interface wiring disconnected from the control unit, check the continuity between pin 28 and the white-red cable, between pin 38 and the blue cable on the geared motor connector

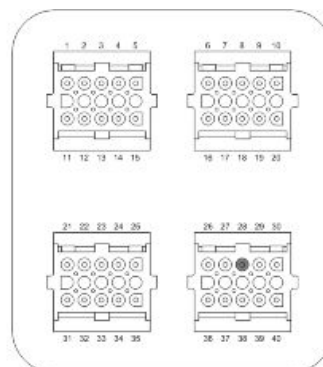

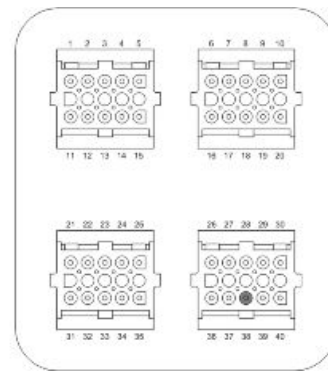

With the interface wiring disconnected from the control unit, check the continuity of the geared motor winding placing the multimeter probes on pins 28 and 38 as indicated in the figure.

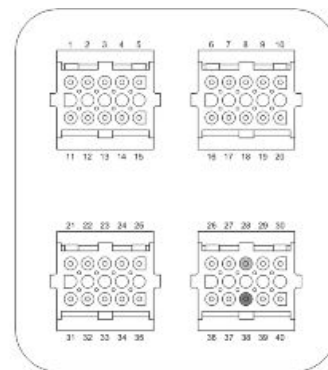

TILT LOCKING-UNLOCKING SWITCH

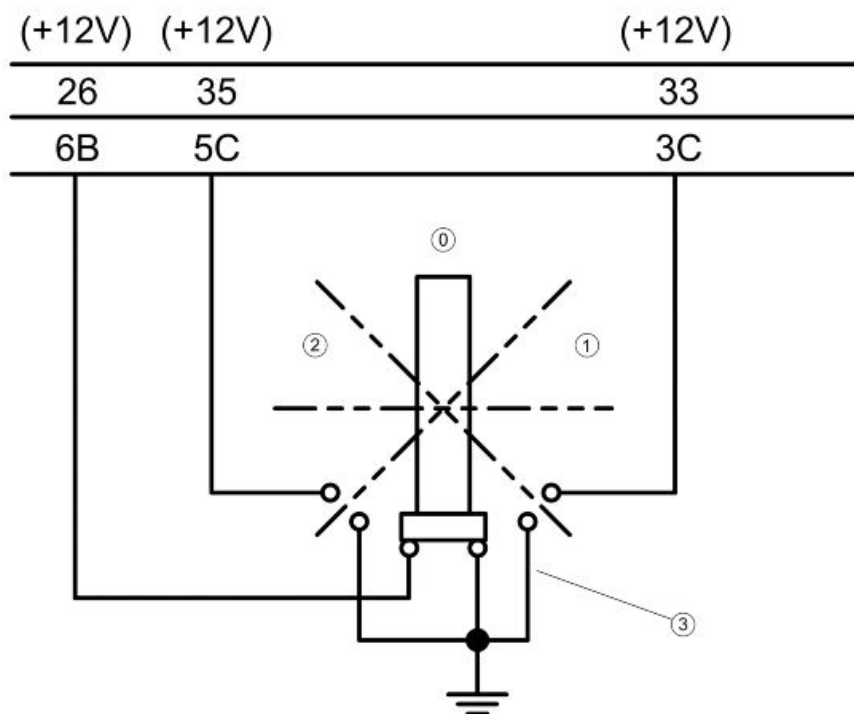

- 0: REST POSITION
- 1: LOCKING POSITION
- 2: UNLOCKING POSITION

### 3: TILT LOCKING-UNLOCKING SWITCH

With interface wiring disconnected from the control unit, check the continuity of the electrical lines between the interface wiring and the tilt locking-unlocking switch:

Pin 26 and green - grey cable

Pin 35 and violet - black cable

Pin 33 and yellow - blue cable

Also check that the above indicated electrical lines are insulated from the earth.

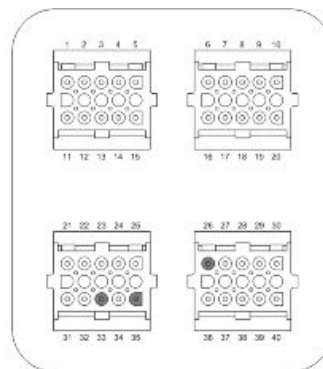
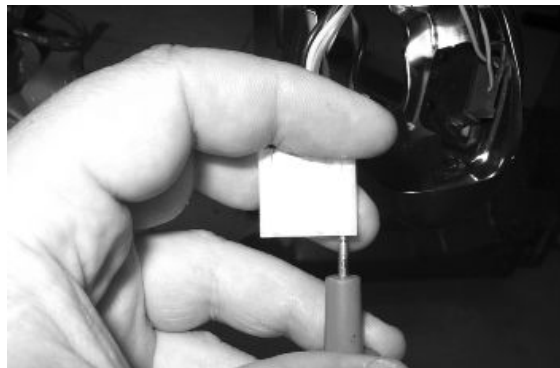

Check the continuity between the black cable on the connector and an earth point on the chassis.

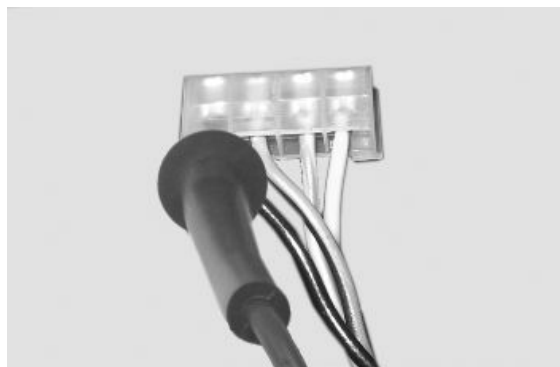

With a multimeter, check the operation of the tilt locking-unlocking switch referring to the diagram indicated in the figure.

**KEY**

- 1. GROUND
- 2. LOCKING
- 3. REST
- 4. UNLOCKING

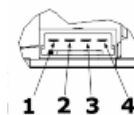

	<b>2</b>	<b>3</b>	<b>4</b>	<b>1</b>
			○	○
0		○	○	○
	○			○

### TILT LOCKING CALLIPER SENSOR



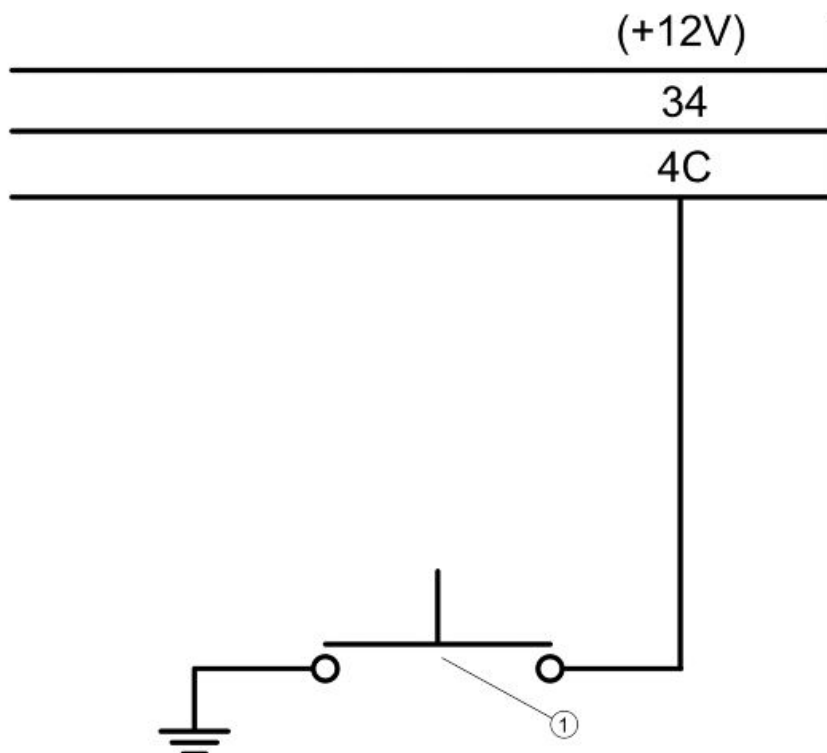

#### 1: TILT LOCKING CALLIPER SENSOR

The tilt locking calliper sensor is a normally opened switch. Check its correct operation with a multi-meter.



With interface wiring disconnected from the control unit, check the continuity between pin 34 and the brown cable of the tilt locking gripper sensor connector on the system side.

Check the continuity of the connector black cable and an earth point on the chassis

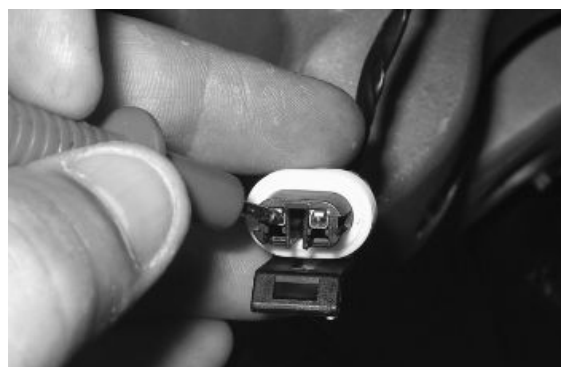

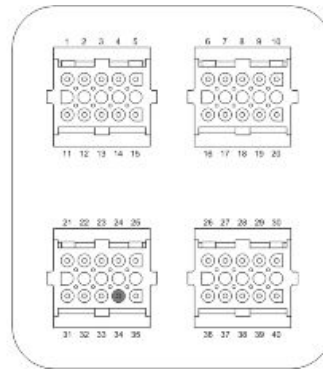

Also check that the flexible transmission control lever activates the limit stop switch properly.

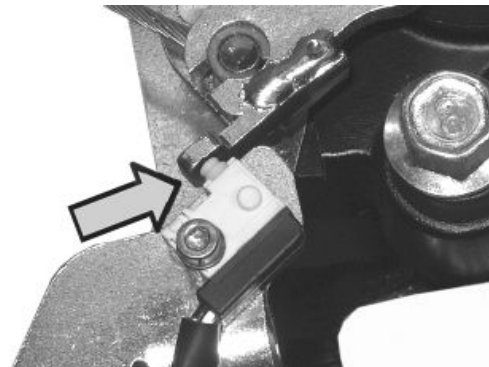

POTENTIOMETER

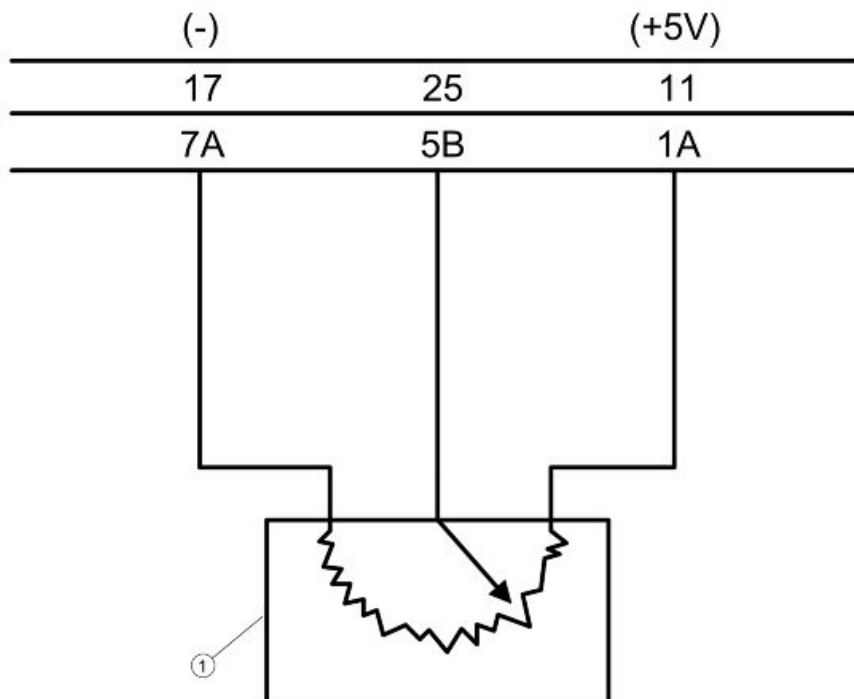

1: POTENTIOMETER

With interface wiring connected to the control unit, secure the vehicle on its centre stand and switch to "ON". Select the reading scale on 20 V. Insert the multimeter probes on pins 17 and 25. Check that the voltage in the activated locking condition is 4V and 1V in the locking to rest condition.

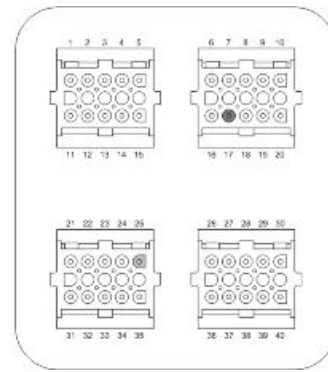

With the interface wiring disconnected from the control unit, check the continuity between pin 17 and the yellow cable of the potentiometer connector, between pin 25 and the green-blue cable, between pin 11 and the orange-blue cable. Also check that these lines are insulated from each other and earth.

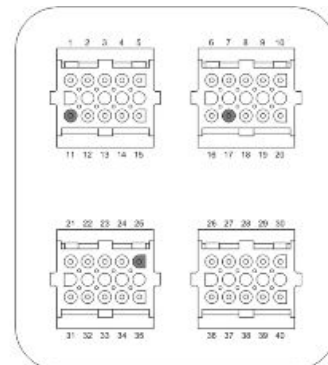
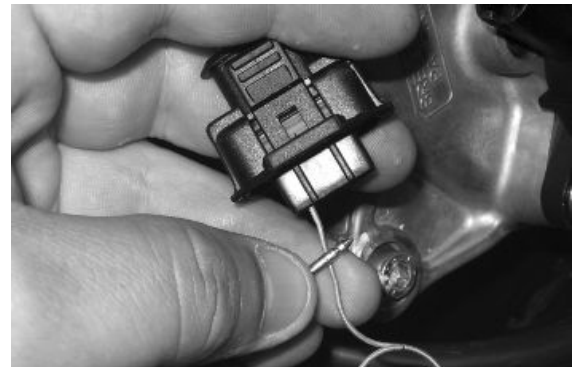

---

## RIDER PRESENCE SENSOR

---

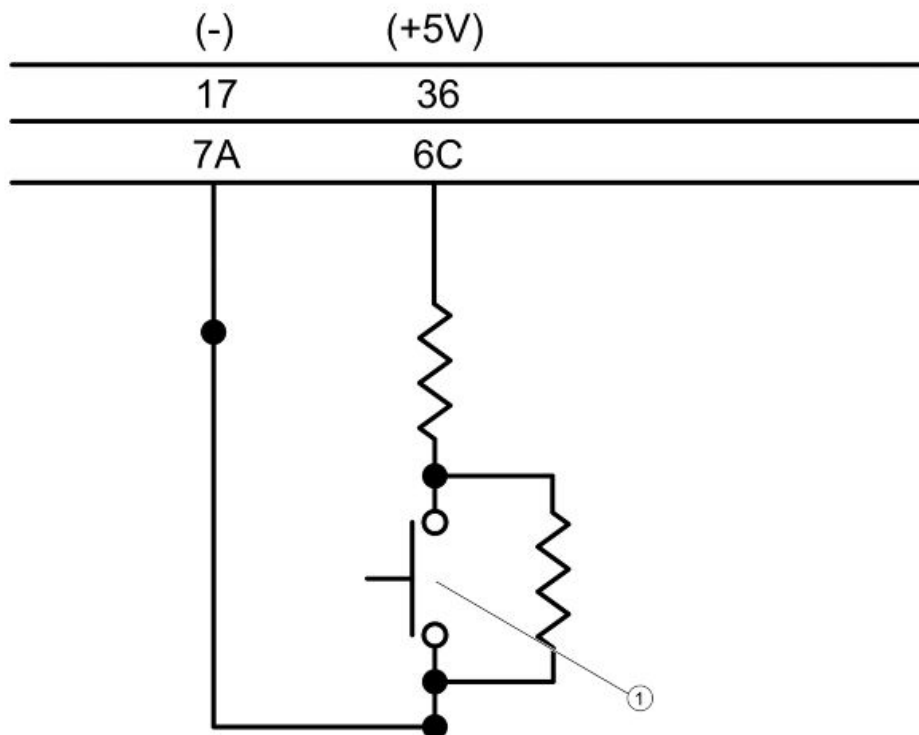

1: RIDER PRESENCE SENSOR

With interface wiring disconnected from the control unit and connected to the system, check the following conditions:

pin 17 - 36: resistance  $15 \div 18$  kOhm when the rider is not seated on the saddle.

pin 17 - 36: resistance of about 3 kOhm when the rider is seated on the saddle

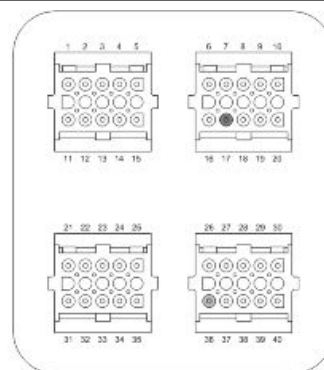

Check the continuity between the interface wiring pin 17 and the yellow cable of the rider presence connector.

Check the continuity between the interface wiring pin 36 and violet cable of the rider presence connector.



1: TONE WHEEL SENSOR

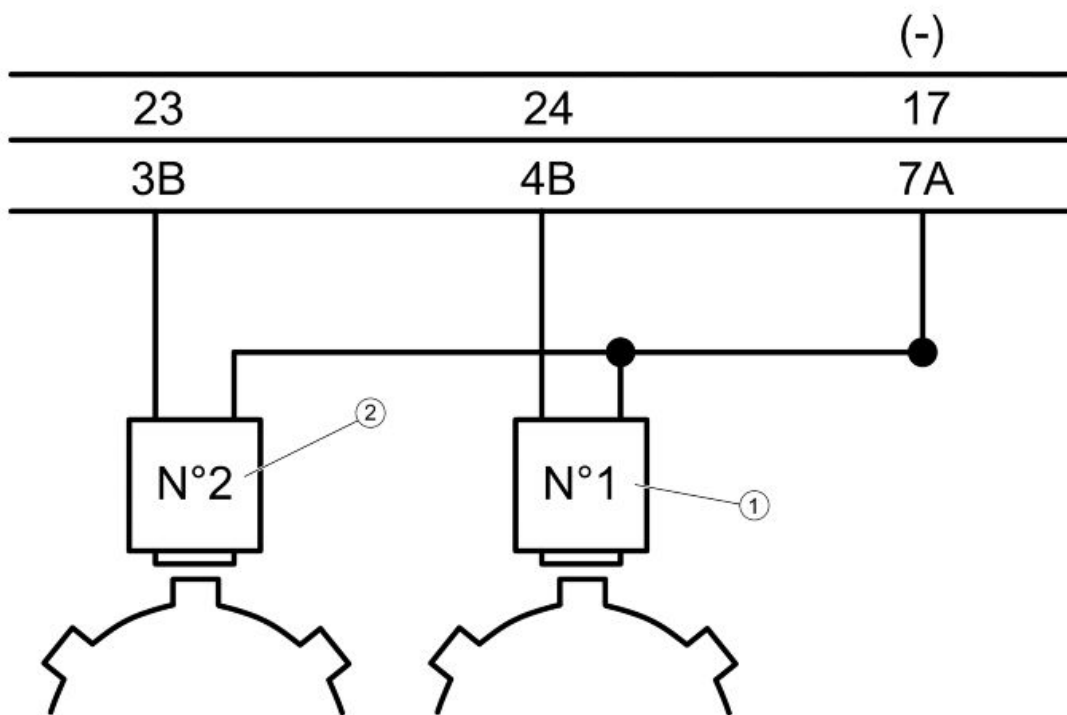

1: Right tone wheel

2: Left tone wheel

With interface wiring disconnected from the parking electrical control unit and connected to the system, check that the sensor resistance between pins 23 - 17 and 24 - 17 is between 774 and 946 Ohm at a temperature of approximately 20°

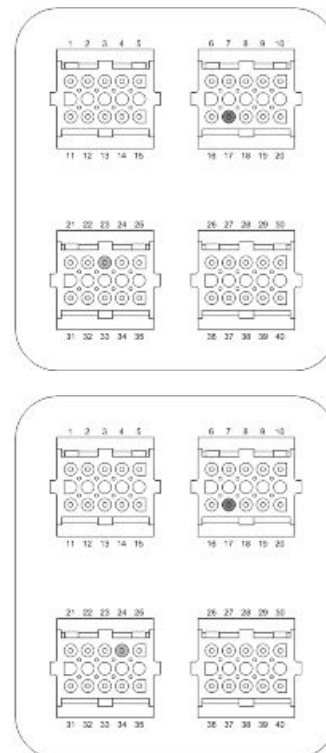

With interface wiring disconnected from the control unit, check the continuity between pin 23 and the red cable of the LEFT wheel turning sensor connector; the continuity between pin 17 and the brown cables of the LEFT and RIGHT wheel turning sensors; and between pin 24 and the red cable of the RIGHT wheel turning sensor.

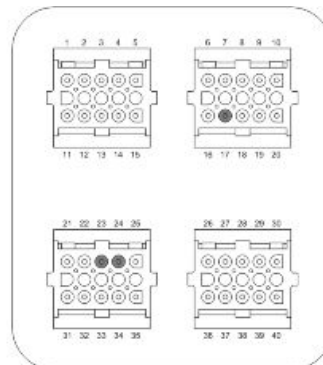

In case of failures, check the continuity between pin 23 and the connector green cable on the fuel tank after removing the chassis central cover; between pin 17 and the yellow cables on both connectors; between pin 24 and the red cable on the connector.



With interface wiring disconnected from the control unit and the connectors disconnected from wheel turning sensors, check that pin 23 - 17 and 24 - 17 are insulated from each other and from earth.

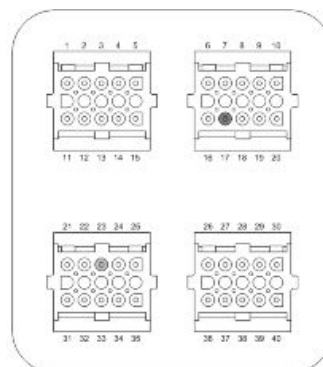

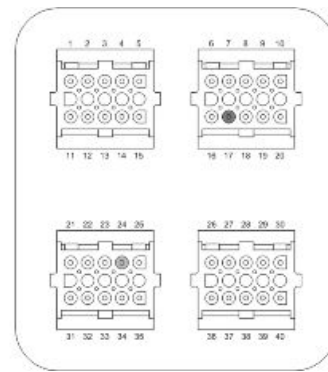

With a thickness gauge, check that the air gap between the screw head and the sensor is between 0.35 and 1 mm



## Wheel alignment

Tool fitting



### Metodo di utilizzo dell'attrezzatura

- Verificare che la pressione pneumatici sia corretta.
- Posizionare il veicolo su un pavimento piano privo di asperità e irregolarità .
- Posizionare il veicolo sul cavalletto centrale.
- Assicurarsi che il sistema di stazionamento sia sbloccato.
- Sollevare le ruote anteriori come mostrato in foto



- Verificare la regolarità di rotazione dei cerchi ruota e l'eventuale presenza di giochi anomali dei cuscinetti e delle sospensioni.
- Verificare che il comando dello sterzo non presenti giochi anomali su giunti e cuscinetti. In caso contrario procedere con le necessarie riparazioni e successive regolazioni.

### Characteristic

#### Front tyre pressure (with passenger)

1.6 bar (1.8 bar)

#### Rear tyre pressure (with passenger)

2.4 bar (2.6 bar)

- Get the vehicle off the stand, back on the ground.
- Remove the right lower coupling plate of the half-arm by undoing the screws indicated in the photograph.

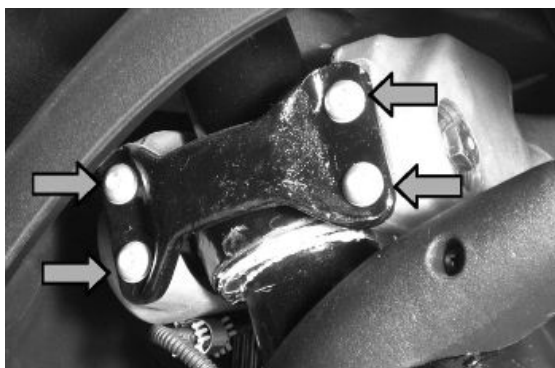

- Remove the right upper screw and the left bottom screw of the parallelogram unit .

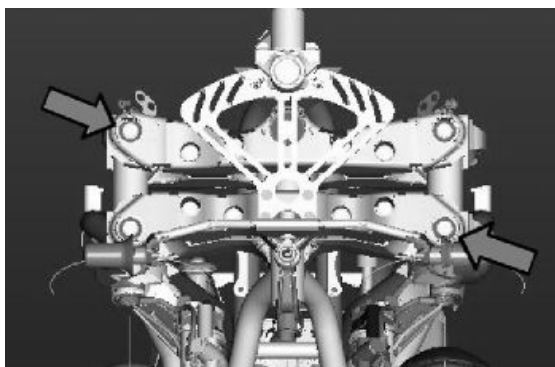





- Fit the bracket locking the parallelogram in the holes of the previously removed screws; use the screws supplied with the tool and be careful to correctly centre the spacer in the bearing.



- Remove the nut fixing the steering control arm and keep the original washer in position.



- Fit the steering guiding bracket in a straight riding position, fix one end to the attachment of the half-arm coupling flange and the other end to the screw fixing the steering control arm.

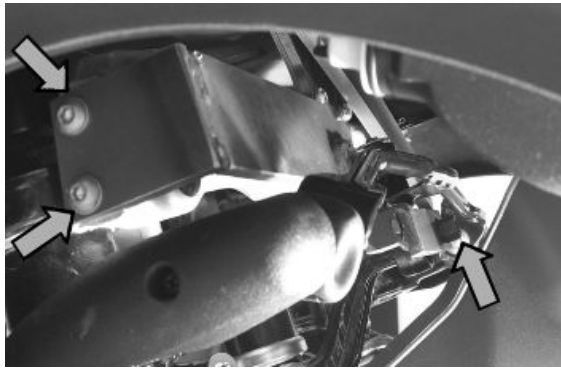

- Place the frame so that the sliders come into contact with the rim maximum diameter but without interfering with the tyre. If required, reposition the frame by operating the 3 adjustable support feet.



- Fit the frame locking bracket

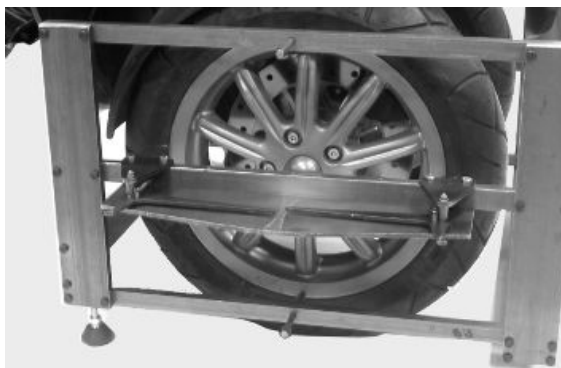
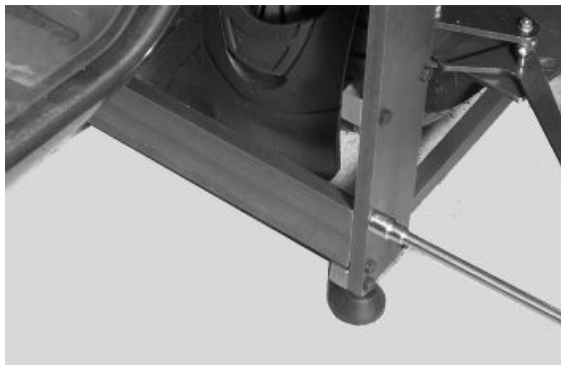

- Make sure the frame is adequately centred by checking with a gauge that the lugs along the vertical axis show the standard protrusion.

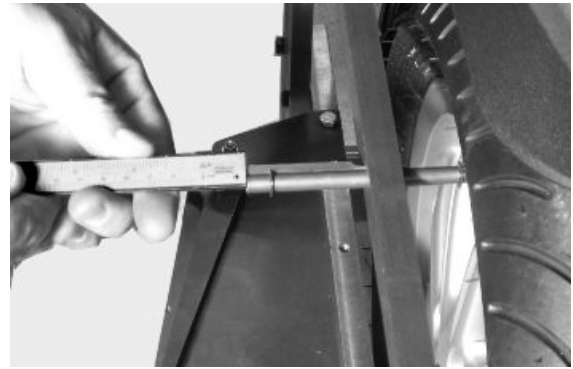

- Check that the pointers of both tyres are correctly aligned, as shown in the photograph. Maximum misalignment allowed: 4 notches

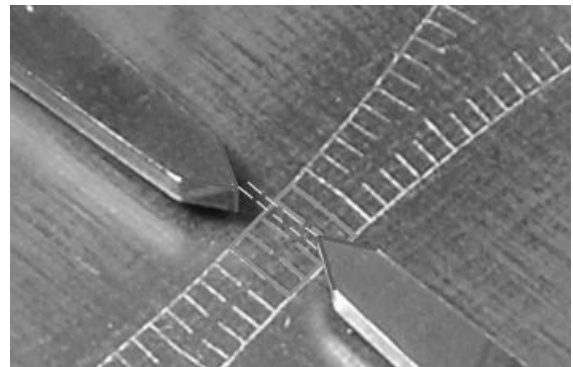

## Rear

### Removing the rear wheel

Before removing the rear wheel, support the vehicle properly and operate the parking brake so as to facilitate removing the wheel fixing screws.

- Remove the exhaust silencer.
- Undo the screw fixing the right shock absorber to the clamp.



- 
- Undo the two screws fixing the clamp to the engine.

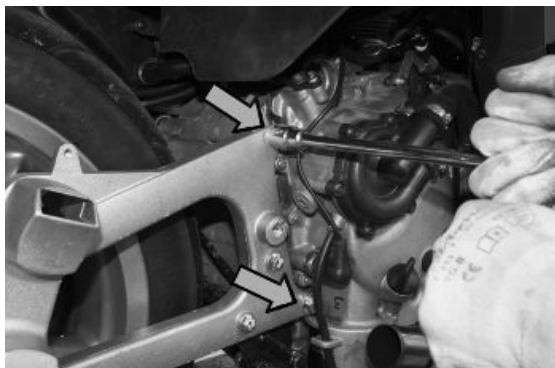

- 
- Undo the two screws fixing the clamp to the centre stand.



- 
- Remove the cotter pin and collect the cap.
  - Unscrew the wheel fixing nut and collect the spacer.



- 
- Unscrew the clamp.



- Collect the conical spacer.
- Undo the five wheel fixing screws and remove the wheel.



## Refitting the rear wheel

To fit, proceed in the reverse sequence from that used for the removal, being careful to fit the distances on the wheel axle as shown in the photograph.

### Locking torques (N\*m)

**Muffler arm clamping screws** 27 ÷ 30  
**Rear wheel axle nut** 104 ÷ 126  
**Shock absorber-crankcase attachment bracket** 20 ÷ 25  
**Lower shock absorber clamping screw** 33 ÷ 41 Nm  
**Rear brake calliper fixing screws** 25 ÷ 30 Nm

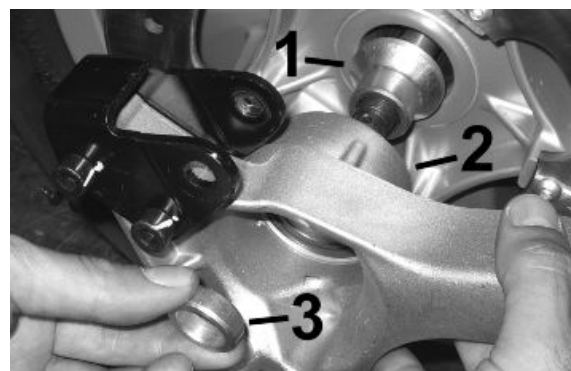

## Swing-arm

### Removal

- Rest the scooter on its centre stand.
- Remove the retainer fixing the swinging arm to the engine, unscrew the nut and remove the bolt.

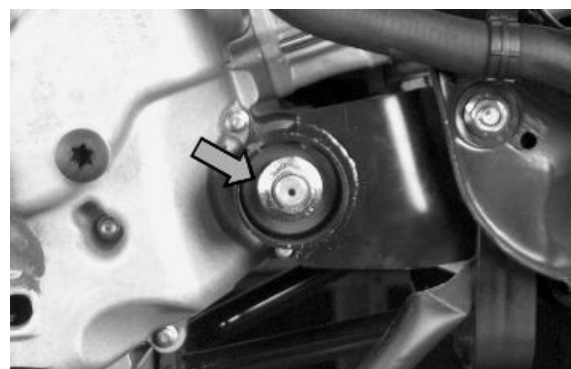

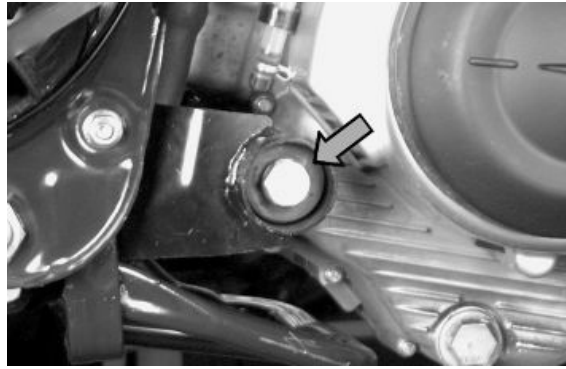

- Remove the silent-blocks.



- Remove the retainer fixing the swinging arm to the frame: undo the screw.



- Remove the pin.



- 
- Unscrew the nut of the set screw bushing.

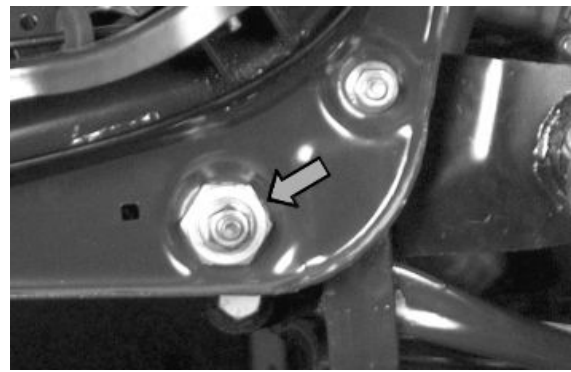

- From the inside loosen the set screw bushing until the swinging arm is free.
- Remove the swinging arm.



- Check the entire swinging arm assembly.
- Check all the components- Teflon bushings, silent-blocks, roller bushings, spacers.
- Replace the work components that cause excessive clearance on the rear suspension.



---

## Overhaul

- Properly support the swinging arm in the vice.
- Check there is no jamming in the movement of the joint connecting the swinging arm on the engine side to the swinging arm on the frame side.
- To check the clearance on the frame-side arm, mount the retainer using the pin fixing the swinging arm to the frame and two adaptor rings of the appropriate tool 020229Y. Alternatively use two washers with inner diameter for 12-mm pins, min. outer diameter: 30 mm: min. thickness: 4 mm.

- Check there is no sticking in the rotation.
- Check the axial clearance of the swinging arm on the frame side

**Characteristic****Standard clearance**

0.40 ÷ 0.60 mm

**Allowable limit after use:**

1.5 mm



- Separate the swinging arm on the engine side from the vehicle side arm.
- Remove the plastic bushings and the internal spacer shown in the photo.

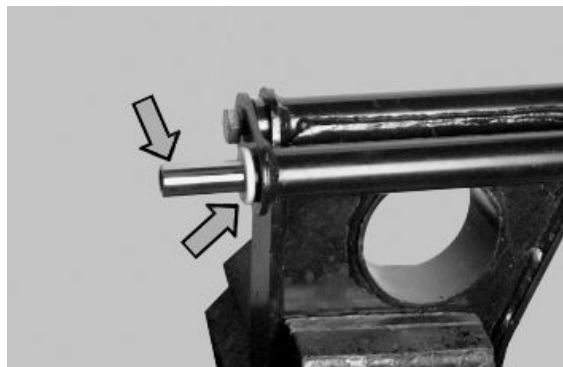

- Remove the pin connecting the engine swinging arm - frame swinging arm.

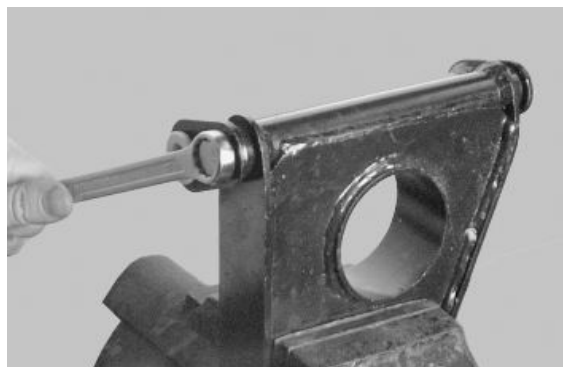

The operations below are described once but apply to both sides of the swinging arm.

- Remove the internal spacer.
- Using a suitable pin remove the roller casings as shown in the photographs





- Using an appropriate tool plant new roller casings, being careful to position the bearings with the O-rings facing outwards

### Specific tooling

**020244Y 15 mm diameter punch**

### Characteristic

**Length of the swinging arm tube on the engine side:**

L 140.5 ± 0.7 mm

**Frame side swinging arm plastic bushing shim:**

3.5 ± 0.05 mm

**Length of the internal swinging arm spacer on the frame side:**

L182.5 ± 0.3 mm

**Length of the swinging arm tube on the frame side:**

L 222.5 ± 0.2 mm

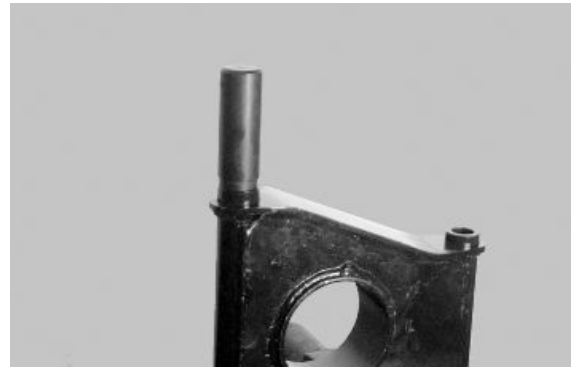

- Lubricate roller casings and the plastic bushings with grease
- Insert the spacers
- Assembly both arms with the appropriate bolt
- Adjust the bolt as shown in the photograph
- Place the swinging arm, frame side, with the protruding part facing the transmission side



### Recommended products

**AGIP GREASE PV2 Grease for the steering bearings, pin seats and swinging arm**

Soap-based lithium and zinc oxide grease containing NLGI 2; ISO-L-XBCIB2 of the swinging arm

- Check that the silent block is not broken. Otherwise, replace it.



- Unscrew the retainer to the frame in order to remove the silent block supporting clamp.



## Refitting

For correct installation of the swinging arm on the scooter, proceed as follows:

1. Position the silent block supporting clamp with part **3** inserted, and slightly tighten part **1**
  2. Position the swinging arm, inserting part **2**
  3. Tighten part **3** to the prescribed torque
  4. Screw on and tighten part **4** to the prescribed torque
  5. Screw on and tighten part **5** to the prescribed torque
  6. Tighten part **1** to the prescribed torque
- Insert the swinging arm - engine bolt and tighten to the prescribed torque

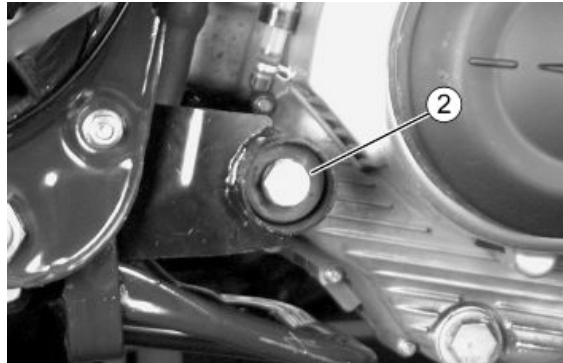
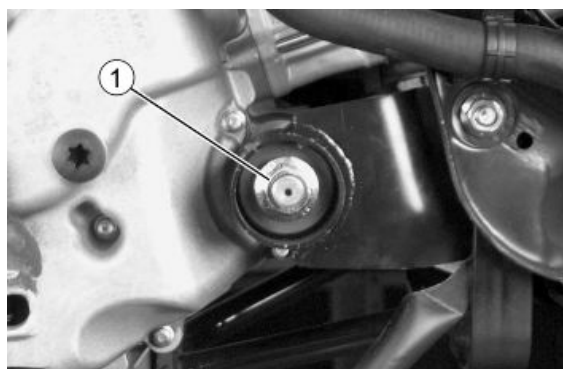

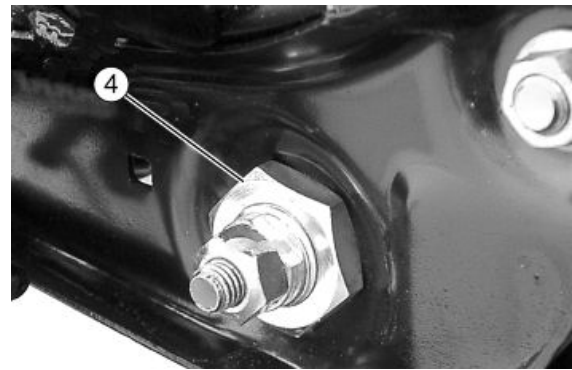

### SWINGING ARM FITTING

Name	Torque in Nm
Part 1	98 ÷ 118
Part 3	5 ÷ 7
Part 4	88.5 ÷ 108
Part 5	54 ÷ 60
Swinging arm, engine side / Swinging arm, frame side, bolt	32.5 ÷ 40

## Shock absorbers

### Removal

Proceed as follows:

- place the scooter on its centre stand;
- lift the engine a little with a jack so as to free the two shock absorbers;
- remove the exhaust silencer;
- undo the shock absorber spring assembly clamping screw from the support fixed to the engine on the one side and from that fixed to the muffler on the other;

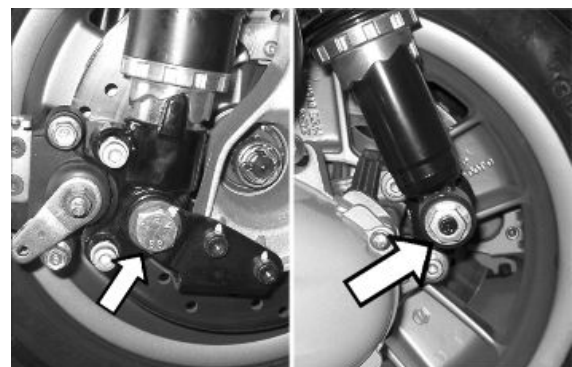

- undo the two upper nuts (one on each side) fixing the shock absorber spring assembly to the frame and remove the shock absorbers themselves.

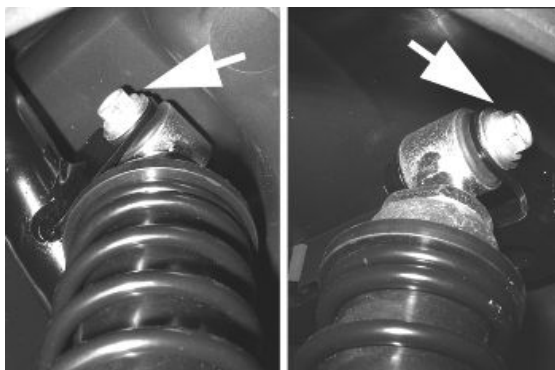

## Refitting

Carry out the previous operations in reverse order.

### Locking torques (N\*m)

Shock absorber lower clamp 33 ÷ 41 Upper shock absorber clamp 33 ÷ 41

## Centre-stand

- Use a jack to support the vehicle properly.
- Remove the two stand return springs.

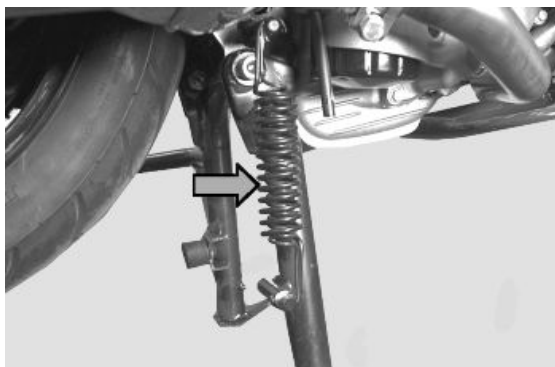

- Working from both sides, undo the two bolts connecting it to the supporting plate.

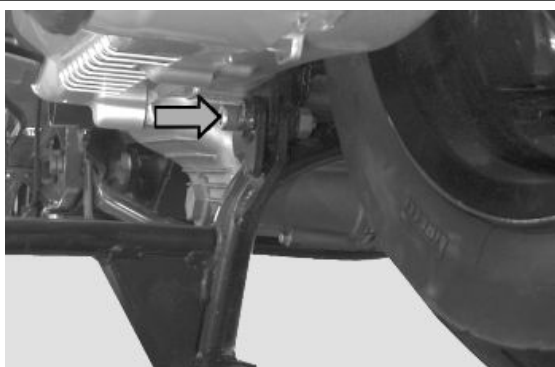

- To refit, follow the removal steps but in reverse order; be careful to tighten to the prescribed torque.

### Locking torques (N\*m)

Centre stand bolt 31 ÷ 39

## INDEX OF TOPICS

**B**RAKING SYSTEM

**BRAK SYS**

This section è is devoted to the description of the brake system components.

## Rear brake calliper

### Removal

- Remove the rear wheel.
- Undo the screws connecting the air filter to the crankcase so that the wrenches can be inserted.
- Undo the two fixing screws and remove the calliper.

**N.B.**

**IF IT IS NECESSARY TO REPLACE OR SERVICE THE BRAKE CALLIPER, BEFORE REMOVING THE FITTINGS FIXING THE CALLIPER TO THE SUPPORT BRACKET, FIRST LOOSEN THE OIL HOSE FITTING AFTER HAVING EMP-TIED THE SYSTEM OF THE CIRCUIT BEING EXAMINED.**



### Overhaul

Proceed as follows:

- 1) remove the two male hexagonal screws (1) and take out the two pads (10);
- 2) remove the two male hexagonal screws (2) and remove the reaction plate (3);
- 3) take out the fixed plate (4) from the guide;
- 4) remove the internal elements from the floating body (5) with the help of short blows of compressed air through the brake fluid pipe in order to facilitate the expulsion of pistons (6).
- 5) Check:
  - that the plates and the body are whole and in good condition;
  - that the cylinder and the floating body of the calliper do not show signs of scratches or erosion, otherwise replace the entire calliper;
  - that the guides of the fixed plate are not scratched or eroded, otherwise replace the entire plate;
  - that the brake pad check spring works properly.

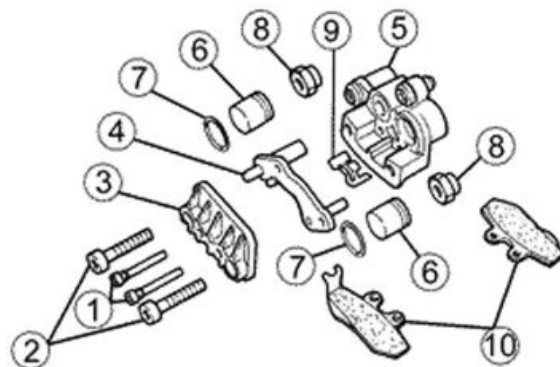

**Refitting**

- 1) insert the pistons (6) and the sealing rings (7) in the body;
- 2) place the guide rubbers (8) and refit the fixed plate (4);
- 3) assemble the reaction plate (3) tightening the screws (2), insert the brake pad check spring (9) and then the pads, fixing them with the corresponding screws (1);
- 5) place the calliper on the disc and lock it to the strut by tightening the fixing screws;
- 6) fix the pipe joint on the calliper at the prescribed torque.

**Functioning**

This is a floating type calliper.

It takes advantage of the action and reaction principle to obtain the thrust for both pads.

The body and the reaction plate body work integrally and can move axially with respect of the fixed plate that is integral to the strut.

The pistons, forced by pressure to push the pad to the disk, cause the reaction plate to push in turn the other pad towards the disc.

**The brake pad lock spring**

1. Pad fixing screws
2. Reaction plate fixing screws
3. Reaction plate
4. Fixed plate
5. Floating body
6. Piston
7. Piston sealing rings
8. Guide protection rubbers
9. Brake pad check spring
10. Pads

**CAUTION**

**ALL THE SEALS AND GASKETS MUST BE REPLACED EVERY TIME THE CALLIPER IS SERVICED.**

**Locking torques (N\*m)**

**Brake fluid hose-calliper fitting 20 ÷ 25 Pad fastening pin 20 ÷ 25**

## Refitting

- To fit the rear brake calliper, follow the removal steps but in reverse order; be careful to tighten the screws to the prescribed torque.

### Locking torques (N\*m)

**Screw tightening calliper to the support 20 ÷ 25**

## Front brake calliper

### Removal

- The operations described refer to only one calliper but apply to both.
- Remove the wheel.
- Undo the two fixing screws to the plate and remove the calliper.

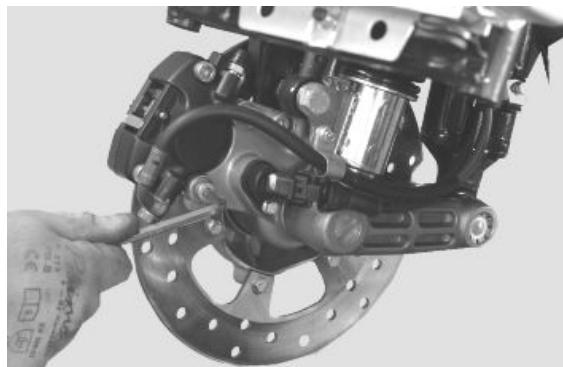

### Overhaul

- Remove the rear brake calliper.
- Suitably hold the brake calliper in a clamp
- Remove the two calliper coupling screws as shown in the photo
- Remove the two pistons from the calliper body with the aid of short blasts of compressed air through the brake fluid holes
- Remove the dust ring and the O-ring of each half calliper.
- Remove the O-rings in the half calliper.



**N.B.**

**WHEN REMOVING THE O-RINGS, BE CAREFUL NOT TO SCRATCH THE HALF CALLIPER SEATS**





- 
- Check that the pistons and their seats show no scratches.
  - Wash and blow all the components carefully
  - Fit the O-rings and new dust guards
  - Refit the pistons in their seats being careful to lubricate with brake fluid
  - Re-couple the half callipers and lock the two screws at the specified torque

**Locking torques (N\*m)****Calliper coupling screw 22 ÷ 27**

---

**Refitting**

---

**Rear brake disc**

---

---

## Removal

- Remove the rear wheel.
- Loosen the nuts fixing the safety washers.
- Undo the two screws fixing the plate supporting the calliper to the frame.

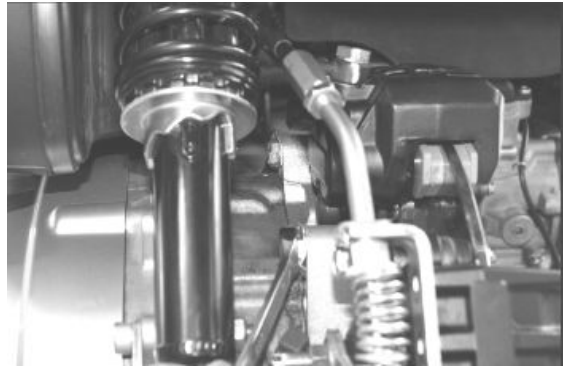

- Remove the calliper supporting clamp.

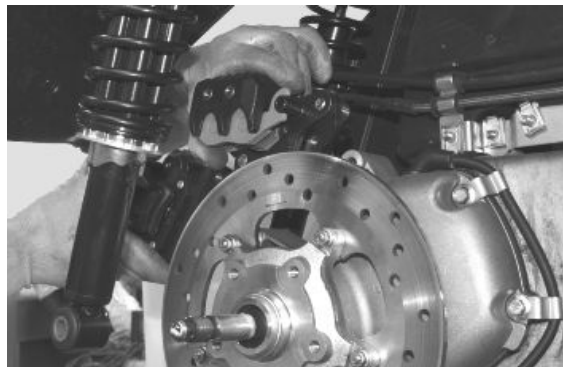

- Remove the brake disc

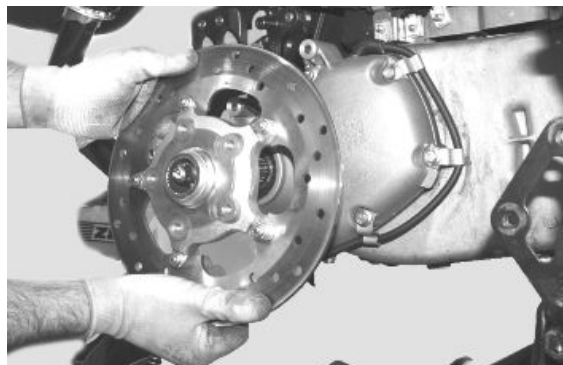

---

## Refitting

- To fit the rear brake disc, follow the removal steps but in reverse order; be careful to tighten the screws to the prescribed torque using threadlock.

### Recommended products

#### Loctite 243 Medium strength threadlock

Medium Loctite 243 threadlock

### Locking torques (N\*m)

Rear disc screws 5 - 6.5 Nm

---

---

## Disc Inspection

Checking the disc is important; it must be perfectly clean, with no sign of rust, oil or grease or other dirt and must not show signs of deep scoring.

### Characteristic

#### New rear disc thickness

5 mm

#### Disc thickness at wear limit (rear)

3.5 mm

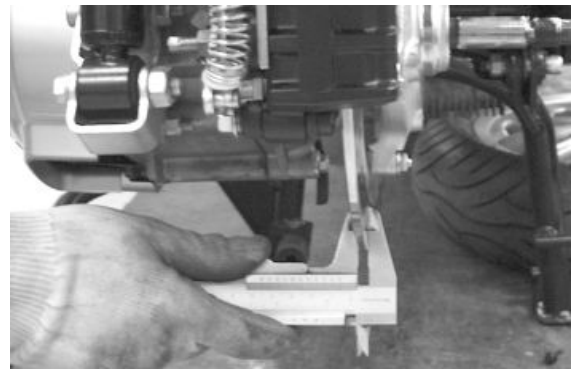

- Remove the wheel and check using the appropriate tools that the axial run-out of the brake surface is within the prescribed limits.
- If this is not the case, replace the disc and repeat the test.

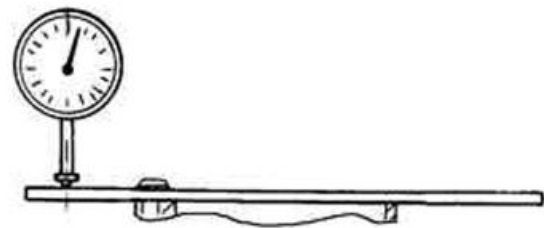

**WHEN INSTALLING, THOROUGHLY CLEAN THE DISC AND ITS SEAT ON THE HUB.**

### Characteristic

#### Max. axial run-out

0.1 mm

---

## Front brake disc

---

### Removal

- The operations described refer to only one disc but apply to both.
- Remove the wheel.
- Remove the brake calliper.
- Remove the cotter pin and remove the cap.



- 
- Unscrew the fixing nut.

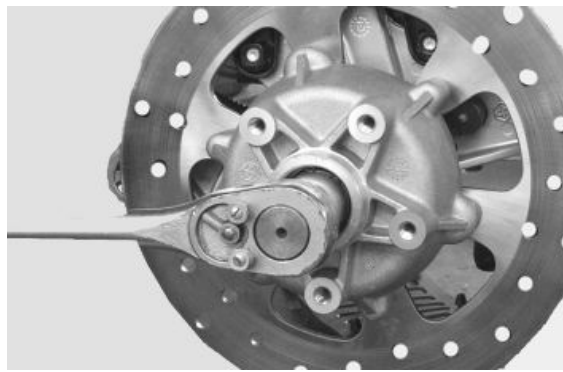

- 
- Remove the wheel hub.

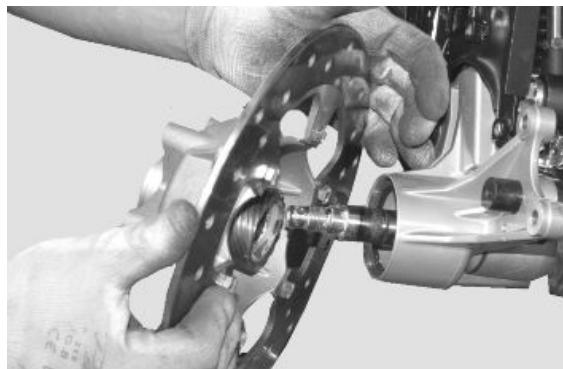

- 
- Unscrew the six bolts securing the disc to the wheel hub.
  - Remove the disc.

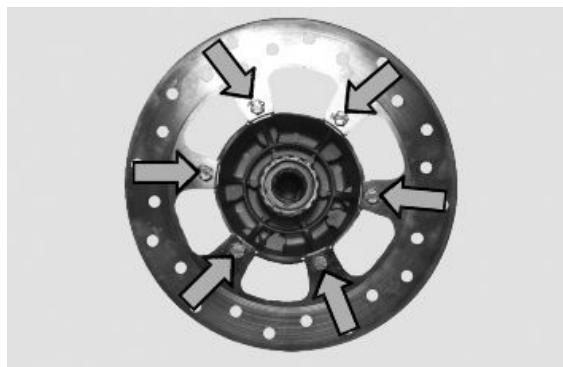

---

## Refitting

- To fit the front brake disc, follow the removal steps but in reverse order; be careful to tighten the screws to the prescribed torque using threadlock.

### Recommended products

#### Loctite 243 Medium strength threadlock

Medium Loctite 243 threadlock

### Locking torques (N\*m)

Front disc screws 5 ÷ 6 Nm

---

## Disc Inspection

Checking the disc is important; it must be perfectly clean, with no sign of rust, oil or grease or other dirt and must not show signs of deep scoring.

**Characteristic****Thickness of a new front disc**

4.0 mm

**Disc thickness at wear limit (front)**

3.5 mm

- Remove the wheel and check using the appropriate tools that the axial run-out of the brake surface is within the prescribed limits.
- If this is not the case, replace the disc and repeat the test.

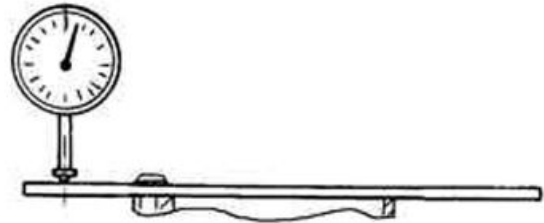

**WHEN INSTALLING, THOROUGHLY CLEAN THE DISC AND ITS SEAT ON THE HUB.**

**Characteristic****Max. axial run-out**

0.1 mm

**Front brake pads****Removal**

- Remove the brake calliper.
- Remove the Benzing snap ring of the pad pin.



- Slide off the pin paying attention to collect the retaining spring of the pads.

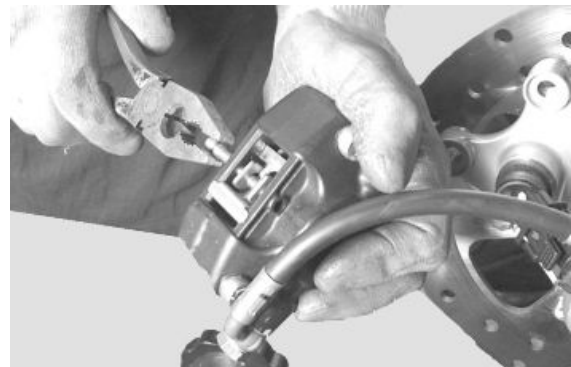

- 
- Remove the pads.

**Characteristic****Minimum value**

1.5 mm

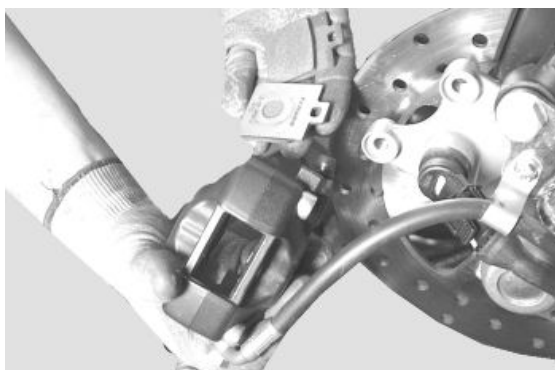

---

**Refitting**

- Follow the removal steps but in reverse order; check that the Benzinger snap ring of the pads is in good conditions.

---

**Rear brake pads**

---

**Removal**

Proceed as follows:

- Remove the rear brake calliper
- Remove the two pins holding the brake pads.
- Remove the pads, paying attention to the pad retaining spring.
- Check the thickness of the pads.

If the thickness is less than the minimum value, replace the pads with new pads.

**Characteristic****Minimum value**

1.5 mm

---

**Refitting**

- To fit the rear brake pads, follow the removal steps but in reverse order; be careful to tighten the screws to the prescribed torque.

**Locking torques (N\*m)**

Screws tightening the pad fixing pin 20 ÷ 25 Nm

---

**Fill**

---

## Rear - combined

Proceed as follows:

- Position the vehicle on a flat surface and on the stand
- Loosen the two screws shown in the figure and open the front brake fluid reservoir.

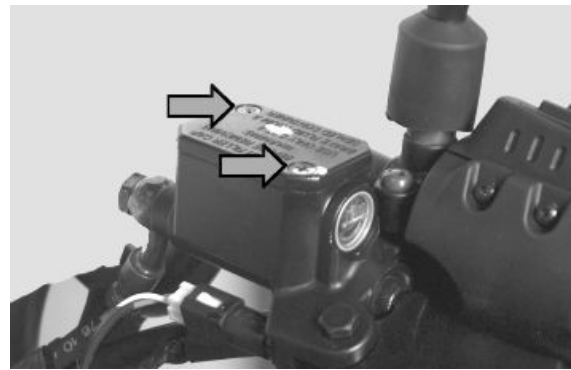

- Through the bleed screw on the brake calliper, bleed the system using a hose of adequate diameter.
- Collect the used fluid in a container.

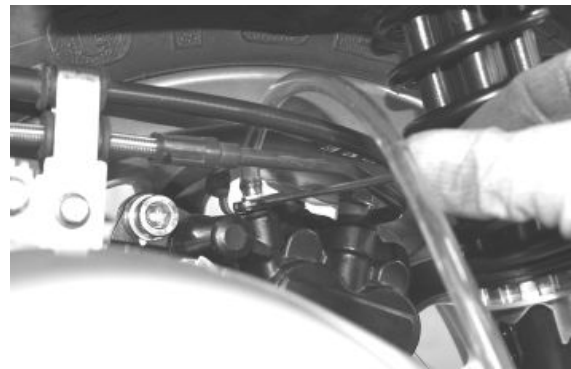

- Pump on the brake lever to completely drain the system of all used fluid.
- Tighten the bleed valve.
- Refill the brake system tank up to the maximum level with the prescribed fluid.
- Attach the tube of the special tool to the bleed fitting.
- Actuate the tool at the bleed fitting, at the same time constantly topping up the brake system tank to prevent air being drawn into the system, until no more air escapes at the bleed fitting. The operation is finished when only brake fluid comes out of the bleed screw.
- Close the bleed screw and tighten to the prescribed torque.
- Close the brake system tank.

### **N.B.**

**IF AIR CONTINUES TO COME OUT DURING THE BLEED OPERATION, EXAMINE ALL THE FITTINGS. IF SAID FITTINGS DO NOT SHOW SIGNS OF BEING FAULTY, LOOK FOR THE AIR INPUT AMONG THE VARIOUS SEALS ON THE PUMP AND CALLIPER PISTONS. WHEN CARRYING OUT THE OPERATION, BRAKE FLUID MAY LEAK FROM THE BLEED SCREW ON THE CALLIPER AND ON THE DISC. IN THIS CASE; CAREFULLY CLEAN THE CALLIPER AND DEGREASE THE BRAKE DISC.**

### **Specific tooling**

**020329Y Mity-Vac vacuum operated pump**

### **Locking torques (N\*m)**

**Oil bleed screw 12 - 16**

## Front

- The operations described refer to only one caliper but are valid and must be observed for both.
- Remove the rubber hood from the bleed screw.
- Insert a rubber pipe in the bleed screw to permit the brake fluid to be recovered.

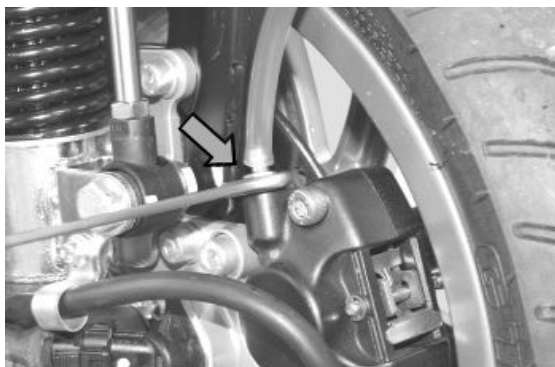

- With the right-hand brake lever, load the system and bring it up to the required pressure.
- Keeping the right-hand brake lever pulled, loosen the bleed screw to permit the air in the system to escape. Then tighten the bleed screw.
- Repeat the operation until only brake fluid comes out of the rubber pipe.
- Remove the fluid recovery pipe and refit the rubber hood over the bleed screw.
- Top up the brake fluid to the right level in the tank.

**N.B.**

**DURING THE BLEEDING OPERATIONS, MAKE SURE THE BRAKE FLUID DOES NOT COME INTO CONTACT WITH THE BODYWORK SO AS NOT TO DAMAGE IT. FURTHERMORE, DURING THE BLEEDING OPERATIONS REGARDING THE BRAKE CALLIPERS, MAKE SURE THE BRAKE FLUID DOES NOT COME INTO CONTACT WITH THE DISC BRAKES AND WITH THE BRAKE PADS. FAILURE TO COMPLY WITH THIS NORM WILL ENDANGER THE PROPER WORKING AND EFFICIENCY OF THE BRAKE SYSTEM**

If necessary, bleeding can be done using a special vacuum pump

### Specific tooling

**020329Y Mity-Vac vacuum operated pump**

**Locking torques (N\*m)**

**Oil bleed screw 8÷12**

## Brake pipes

- Unscrew the braking splitter screw.
- Disconnect the brake pipes removing the two metallic straps indicated in the figure.
- Remove the brake oil tube fitting from the rigid pipe inside the front suspension arm and loosen the hydraulic joint fixing nut of the suspension locking to release the brake pipes.

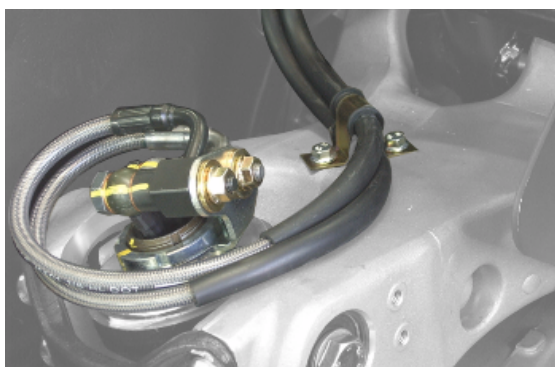



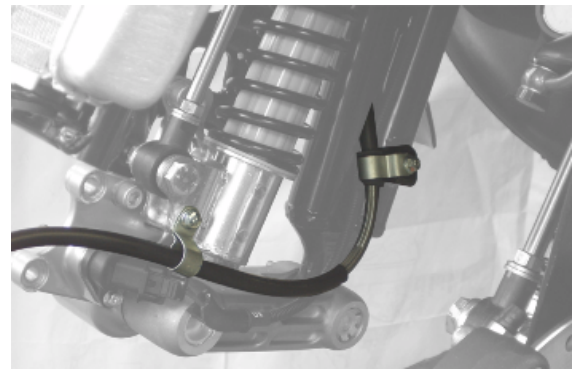

---

Remove front Shield.

Remove front wheel and mudguard.

Disconnect the brake pipes from the calliper and drain the brake fluid.

Then, remove the plastic and metallic straps.

Unscrew the brake pump pipes as indicated in the figure.

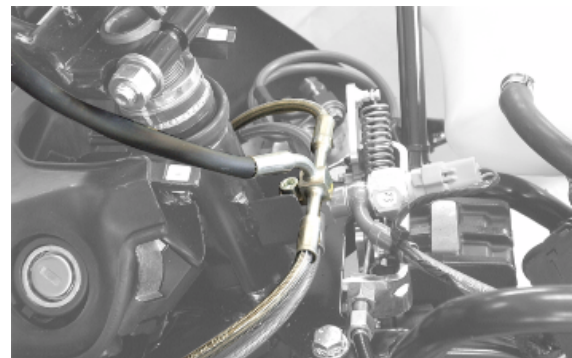

---

## Parking brake

Remove the rear wheel.

Loosen the transmission set screw and release the cable from the calliper.

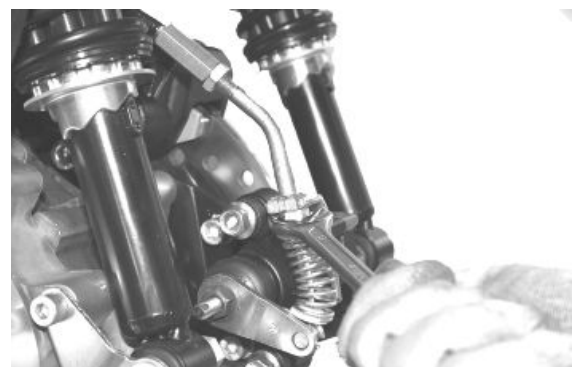

Remove the two fixing screws of the mechanic calliper and remove the calliper. To check calliper components, refer to the chapter on the tilt locking calliper.

When refitting, secure to the specified torque.

### Locking torques (N\*m)

**Screw tightening calliper to the support 20 ÷ 25**

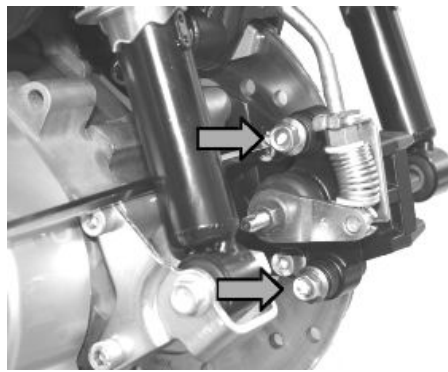

After removing the shield back plate, remove the engaging cable for the safety mechanism removing it from its fitting.

Remove the 4 screws shown in the figure.

When refitting, pay attention to insert the metallic cable peg in the fitting marked «A» as indicated in the enlarged photograph.

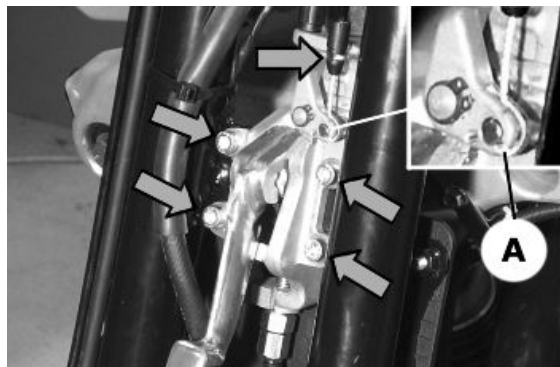

Remove the electric connection from the engaged parking brake warning light switch.

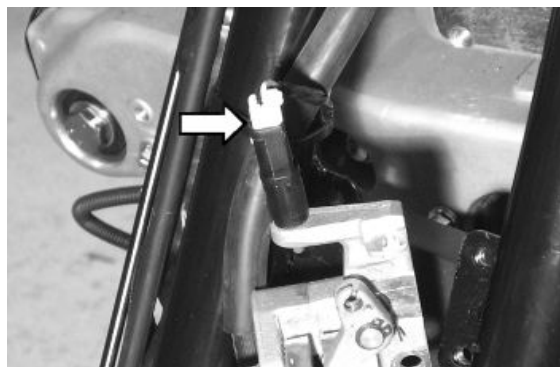

Remove the parking brake cable from the lever by operating the set screw indicated in the photograph.

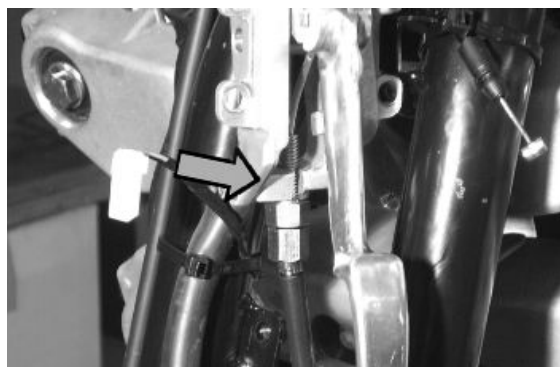

# INDEX OF TOPICS

COOLING SYSTEM

COOL SYS

---

## Circuit diagram

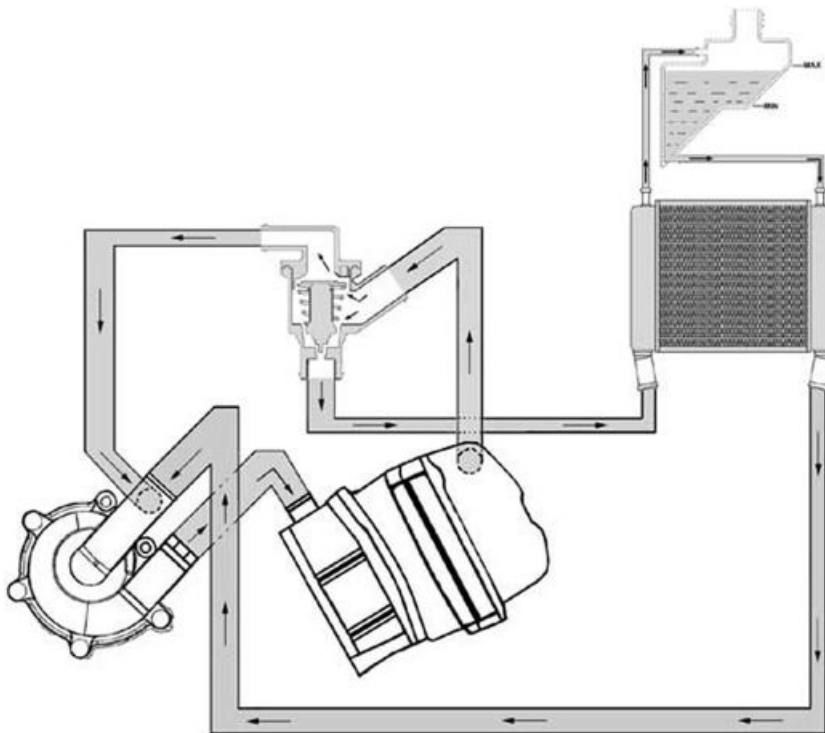

The cooling system is of the forced circulation type, with continuous venting and air pressurisation.

Circulation takes place by a centrifugal pump driven by the countershaft.

The pump delivers the coolant to the thermal unit.

The two-way thermostat support is connected in output to the head. One way is connected to the pump and the other to the radiator (of the horizontal circulation type).

The radiator output is directly connected to the pump.

The expansion tank is connected in parallel to the radiator.

The radiator hot box is connected to the upper side of the expansion tank (in air).

The radiator cold box is connected to the lower side of the expansion tank (in the fluid).

When the engine is cold, the thermostat output to the radiator is closed, even though there is still a little flow for de-aeration obtained by a hole into the closing plate.

In this case, the circulation into the thermal unit is active to ensure an even heating.

Once the working temperature has been reached, the main circulation on radiator and expansion tank starts.

With the small openings in the thermostat there is a flow overlapping (recirculation and main one).

When the temperature is higher, the thermostat allows excluding the recirculation to favour the main circulation.

In this case, the flow is consistent in the expansion tank as well, and this ensures a continuous automatic venting.

For the system venting during the circuit filling step, there is a special union at the top of the head (see filling rules).

To ensure cooling in case of poor dynamic ventilation, there is an electric fan controlled by the injection system.

### TECHNICAL SPECIFICATIONS

Specification	Desc./Quantity
Cooling system capacity	1.8 l
Prescribed fluid	Mixture of 50% water and 50% fluid for sealed circuits
Sealing pressure	Cap calibrated at 0.9 bar

### THERMOSTAT

Specification	Desc./Quantity
Type	Wax, with deviator
Starts opening	90 ± 2°C

### ELECTRIC VENTILATION

Specification	Desc./Quantity
Type	With piston
Electric ventilation start	105°C
Electric ventilation end	100°C

### WATER PUMP

Specification	Desc./Quantity
Type	Centrifugal
Control	Coaxial at the countershaft

### RADIATOR

Specification	Desc./Quantity
Type	Aluminium, with horizontal circulation

### EXPANSION TANK

Specification	Desc./Quantity
Calibration	Automatic bleeding, in parallel with the radiator

## Electric fan check

- Connect the injection diagnostic tester and select the menu on the "ERRORS" function.
- Check any failures in the electric fan control circuit (see "Injection" chapter)

### Specific tooling

020460Y Scooter diagnosis and tester



- Select the menu on the "ACTIVE DIAGNOSIS" function and start the electric fan operation simulation (see "Injection" chapter).
- If the electric fan is certainly efficient, check the ventilation start and end temperature.



- Select the "PARAMETERS" function in the menu to display the coolant temperature.

Electric fan starts: 105°C

Electric fan stops: 100°C

- If non-conforming values are detected, replace the injection control unit (see «Injection» Chapter).
- If the analogue instrument temperature is close to the red zone, but the degrees indicated by the diagnostic tester are below the electric fan start temperature, check the temperature sensor on the head and the relevant injection circuit (see «Injection» chapter);



**N.B.**

**THE ELECTRIC FAN TEMPERATURE AT 105° C CAN ONLY BE MANAGED BY A SYSTEM SUPPLIED WITH A 50% MIXTURE AND PRESSURISED AT 0.9 BAR.**

## System sealing check

- Check the proper circuit sealing when it is in pressure and at the temperature.
- For a more accurate check, wait until the system has cooled down since small leaks may not be visible due to evaporation
- The water pump is provided with a drainage hole in case of leaks from the cooling system mechanical seal, or from the shaft sealing oil guard.
- If coolant or oil leaks are detected, replace the pump (see «Flywheel Cover» Chapter).

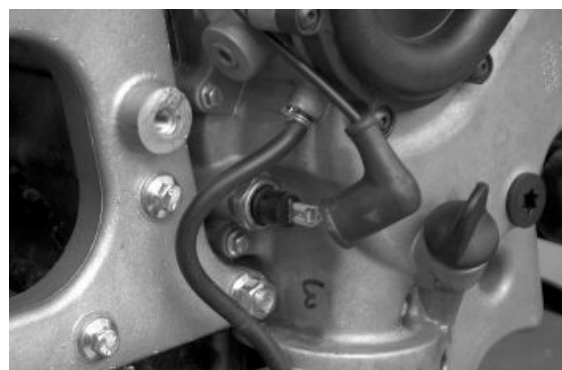

**N.B.**

**DO NOT USE OILS OR GREASES WHILE MOUNTING THE COOLING SYSTEM. FAILURE TO OBSERVE THIS REGULATION CAN CAUSE IRREVERSIBLE DEFORMATION TO THE SEALING GASKETS.**

## Coolant replacement

### System top-up rules

- Prepare the mixture of 50% water and coolant.
- Fill the system to reach a level ranging between the MIX and MAX levels indicated in the expansion tank filler.
- Do not close the expansion tank with the cap.

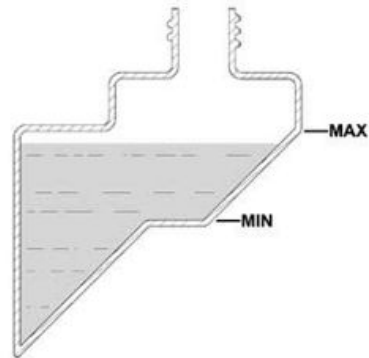

- Use a transparent hose to connect the venting union with the expansion tank filler.
- Loosen the vent and start the engine.

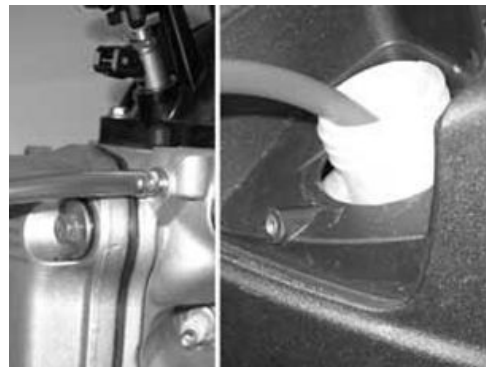

- Keep it open until the air has been fully vented.
- Close the bleed screw.
- Stop the engine.
- Restore the level into the expansion tank and tighten the cap.
- Start the engine and let it warm up to reach the electric ventilation temperature.
- Stop the engine.
- Restore the level with cold engine.

### CAUTION

**ELECTRIC VENTILATION IS CONTROLLED BY THE TEMPERATURE MEASURED AT THE HEAD. THE ELECTRIC VENTILATION START DOES NOT MEAN THAT THE VENTING HAS BEEN COMPLETED.**

**VENTING IS COMPLETE WHEN THE EXPANSION TANK TEMPERATURE RISES.**

## Pompa acqua

### Water pump

If noise or loss of liquid at the drain hole of the water pump is discovered, replace the flywheel cover and the water pump as described in the "Flywheel Cover" Chapter.

Proceed to carry out a few preliminary operations as described below:

- Place the vehicle on its centre stand and on flat ground.
- Remove the bodywork components as described in the "Bodywork" Chapter.

- Remove the muffler to access the flywheel cover as described in the "Removing the Engine from the Scooter" Chapter.
- Empty the cooling system, removing the hoses located on the water pump cover and the loading cap located on the expansion tank.

**CAUTION**

**THIS OPERATION MUST BE CARRIED OUT WHEN THE ENGINE IS COLD.**

- Remove the water pump cover shown in the figure by loosening the 6 fastening screws.
- Proceed to partially drain the circuit as described in the "Engine" Chapter.
- Once the fault has been fixed and all components have been replaced, fill and purge the system again.

**N.B.**

**FOR CHANGING THE COOLANT AND BLEEDING THE SYSTEM, SEE THE "COOLANT CHANGE" SECTION.**

**Characteristic**  
**Cooling system**

~ 1.8 l

**Removing the water pump cover:**

- Check that the water pump cover is not deformed or dented.
- Check that the sealing O-ring is in good working order.
- Otherwise, replace the component.



- Correctly fit a new O-ring, do not allow it to come into contact with grease or oil.

**CAUTION**

**FAILURE TO OBSERVE THIS ADVICE CAN IRRETRIEVABLY DEFORM THE O-RING.**

- Refit the water pump cover and tighten the 6 fixing screws to the prescribed torque.

**Locking torques (N\*m)**

**Water pump cover screws 3 ÷ 4**

**See also**

[Flywheel cover](#)  
[Engine](#)



**diagnosis**

---

**Excessive system pressure**

1 - Check the expansion tank cap efficiency.

**N.B.**

**THE CAP IS PROVIDED WITH AN OVERPRESSURE VALVE CALIBRATED AT 0.9 BAR.**

There is also a valve that must allow air inlet during the cooling step.

YES go to 2 NO go to 3

2 - Check the head gasket seal (see "Thermal unit and timing system" chapter)

3 - Replace the cap.

---

**Cooling fluid consumption**

1 - Check the system outside seals as described above.

YES go to 2 NO go to 3

2 - Check the head gasket seal (see "Thermal unit and timing system" chapter)

- If water leaks are detected in the engine oil, inspect the pad on the head cooling circuit.

3 - Fix any damaged seals.

---

**Oil in the fluid**

1 - Oil into the coolant.

YES go to 2

2 - Check the head gasket seal (see "Thermal unit and timing system" chapter)

---



## INDEX OF TOPICS

**CHASSIS**

**CHAS**

This section è is devoted to the operations that can be carried out on the vehicle's bodywork.

---

## Seat

- Raise the saddle.
- Undo the screw shown in the figure, remove the cover and disconnect the rider presence sensor connector.



- Remove the three fixing screws shown in the figure.



---

## Instrument panel

- Remove the front handlebar cover.
- Remove the front shield.
- Remove the shield back plate upper side.
- Unscrew the six fixing screws and remove the instrument panel.

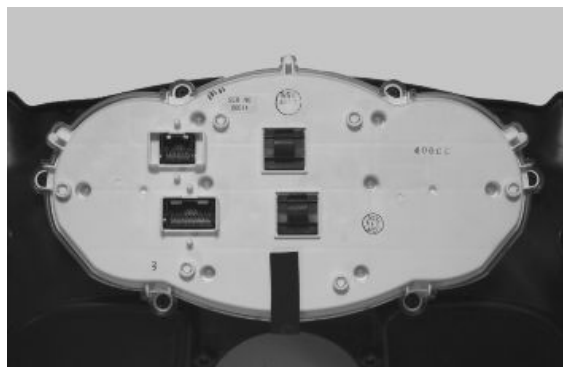

---

**Front handlebar cover**

- Unscrew the six screws and remove the upper cap and the rear handlebar cover.

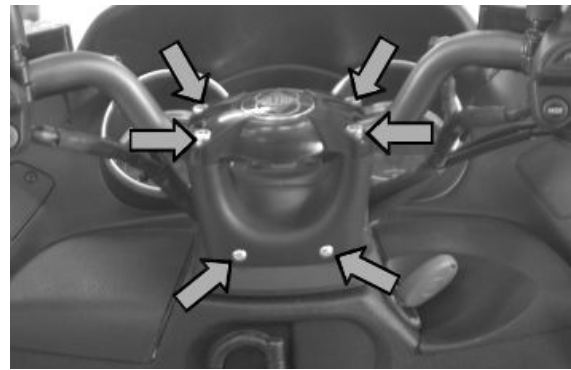

- Unscrew the two screws fixing the handlebar to remove the front part of the handlebar cover.

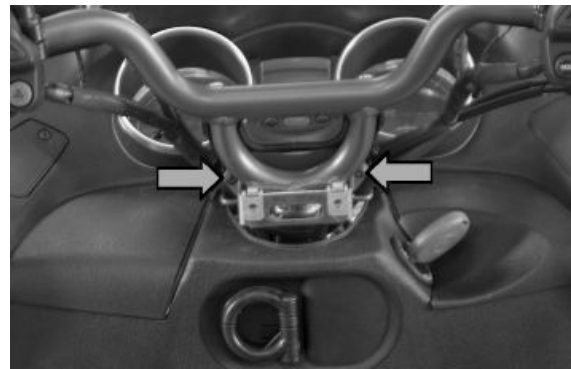

---

**Headlight assy.**

- Remove the front shield.
- Unscrew the screw of the tail light support.

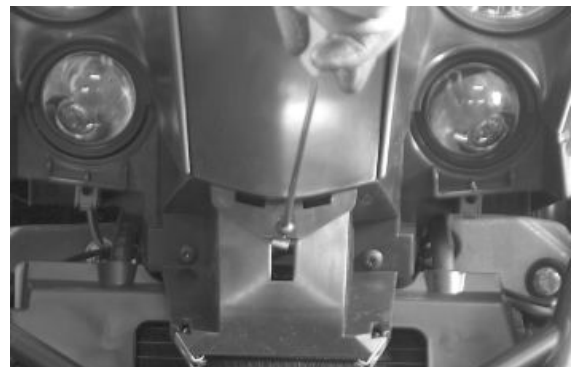

- Disconnect the electrical terminals and remove the support.



- 
- Undo the two screws fixing it to the frame.

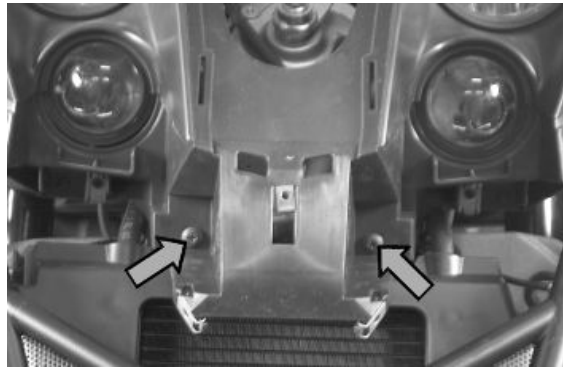

- 
- Undo the two screws fixing it to the upper part of the shield back plate.



- 
- Disconnect the assembly connectors at both sides and remove the support.

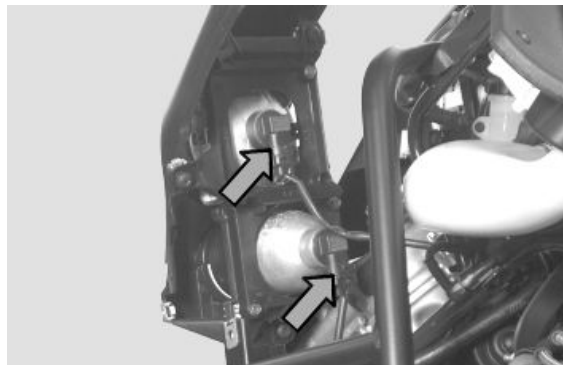

- 
- Undo the ten screws fixing it to the support and remove the headlight assemblies.

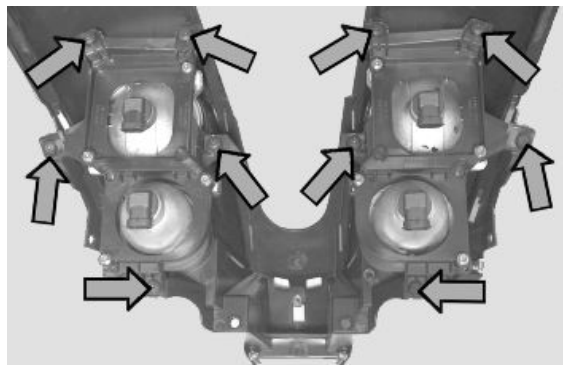

**Frame central cover**

- Unscrew the fuel tank cap.
- Remove the saddle.
- Remove the side fairings

Working from both sides:

- Undo the screw indicated and remove the cap lid.



- Undo the two screws.

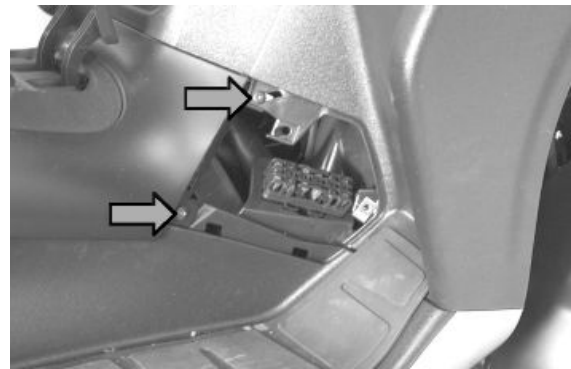

- Undo the screw connecting it to the helmet compartment.

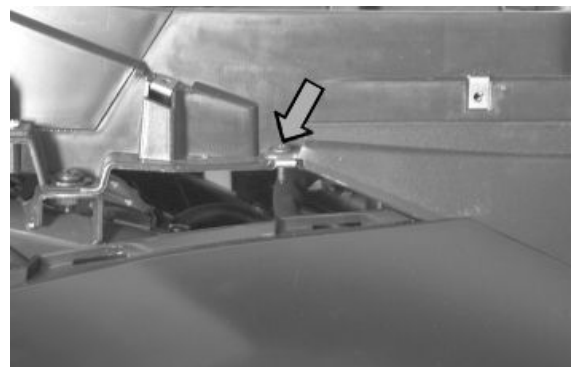

- Lift it so that the refuelling compartment opening cable can be released.
- Remove the central frame cover.



## Legshield

- Remove the spoiler.
- Unscrew the four screws indicated and remove the lower part from the headlight assembly support.

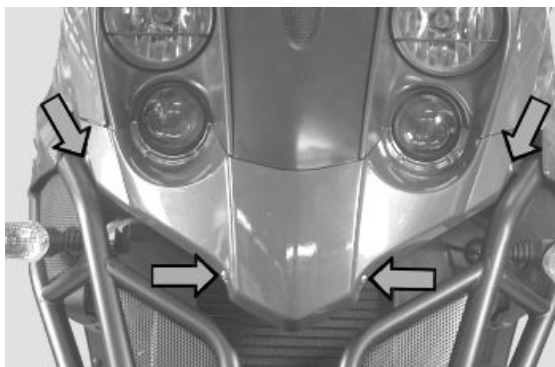

Working from both sides, remove the lateral sections of the front shield:

- Undo the two screws fixing it to the shield back plate, in the wheel housing, and to the upper part of the shield back plate.

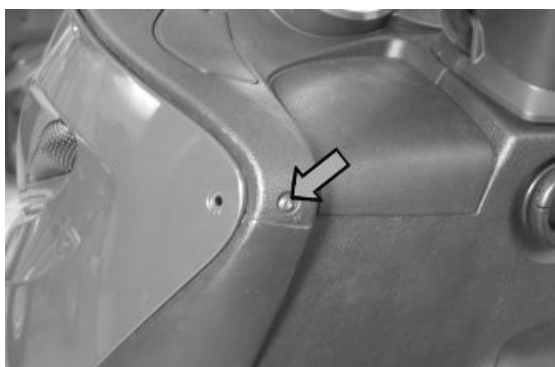
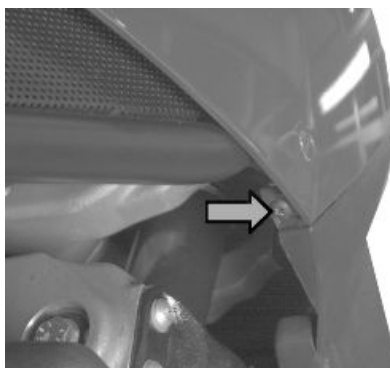

- Unscrew the three screws indicated, release the cover from its fittings and remove it.





**Knee-guard**

- Remove the front shield.
- Remove the handlebar covers.
- Remove the spoiler.
- Remove the two central screws and the coolant cap cover screw.

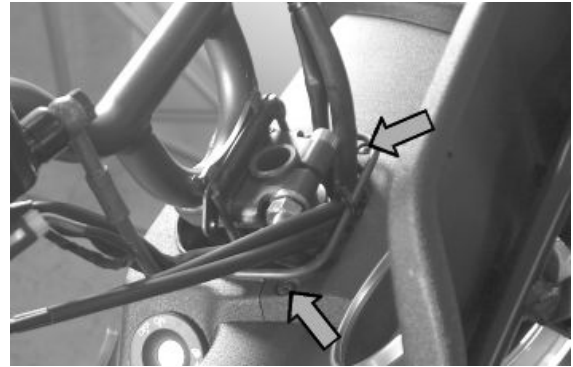

- Remove the expansion tank fixing screw and the frame from the instrument panel and manually release the unions with the shield back plate.
- Unhook the instrument panel wiring.

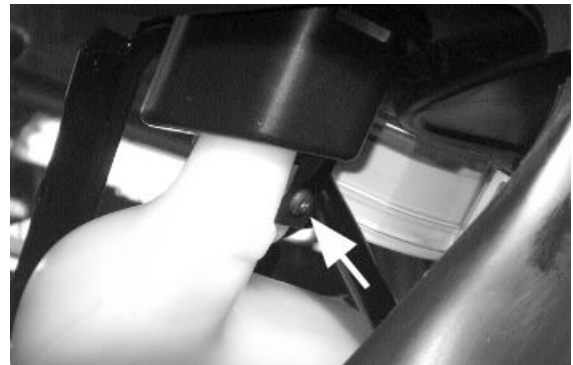

- Remove the six screws and the cable guide strap in the front part of the shield back plate.



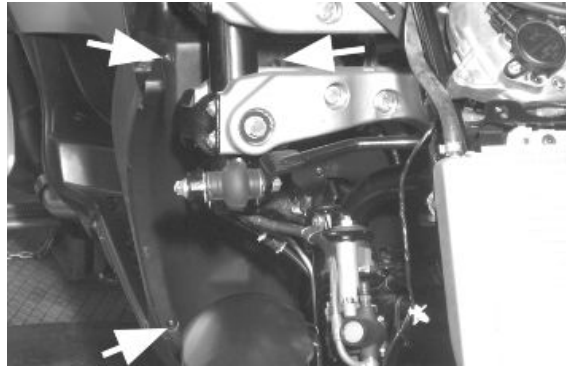

- Remove the key switch plastic ring and the two plastic covers near the footrest.

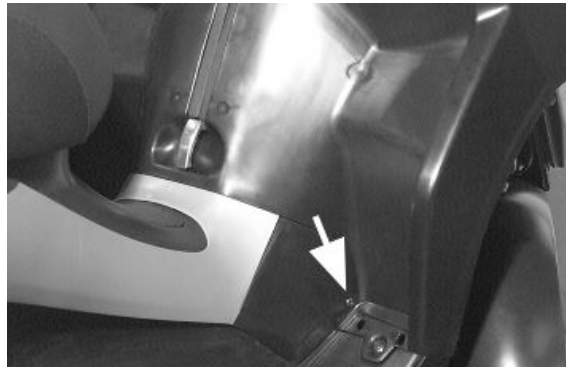

- Remove the five screws on the shield back plate rear part.

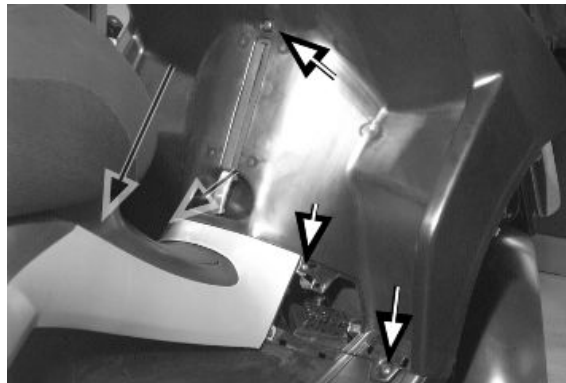

- Remove the two shield back plate front screws, see figure.

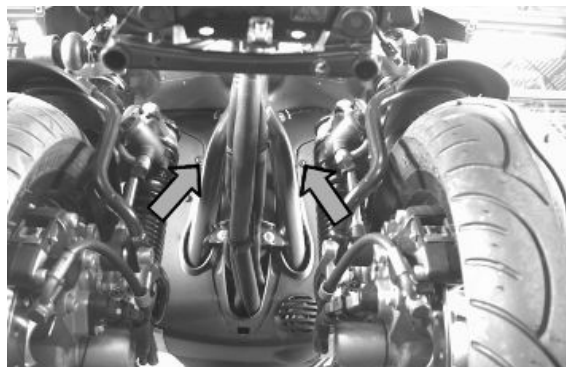

- Remove the two shield back plate lower screws.
- Remove the external temperature sensor connection.

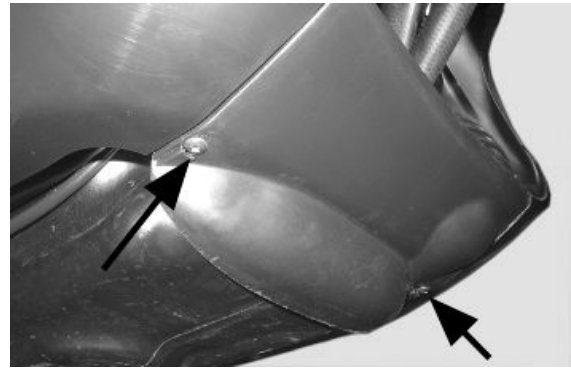
**See also**

[spoiler](#)  
[Legshield](#)

**Taillight assy.**

- Remove the side fairings.
- Remove the handgrips.
- Undo the screw indicated in the figure.

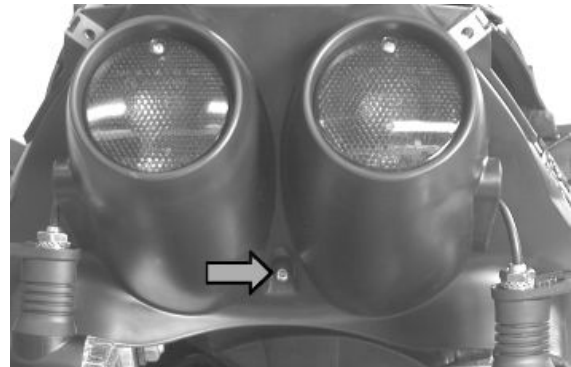

- Undo the two screws connecting it to the helmet compartment.

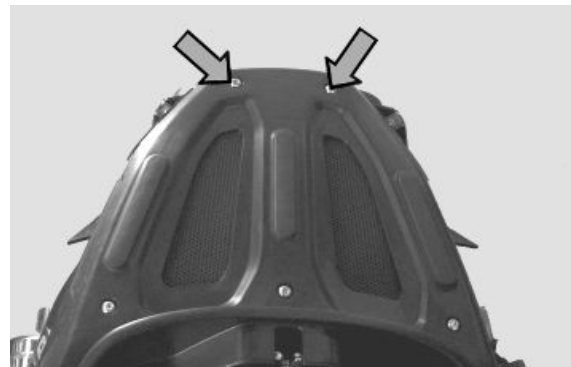

- Disconnect the connectors and remove the support.
- Undo the three screws and remove the light unit.

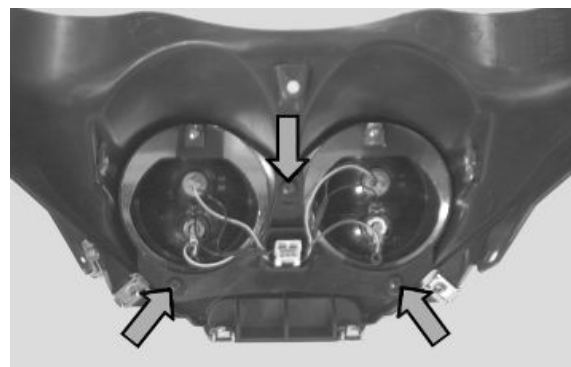

---

## Footrest

Remove the central cover.

Remove the four screws and extract the half-footrest.

Follow the same procedure for both half-footrests.

Release the fuse-box

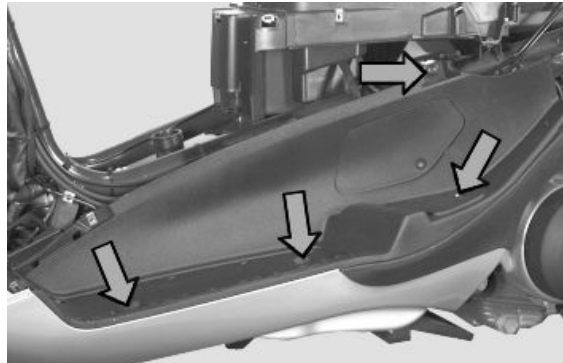

### See also

[Frame central cover](#)

---

## Side fairings

- These operations are described once but apply to both side fairings.

- Undo the three screws on the handgrip cover.

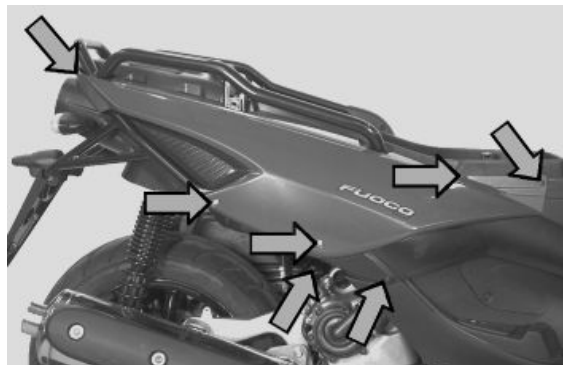
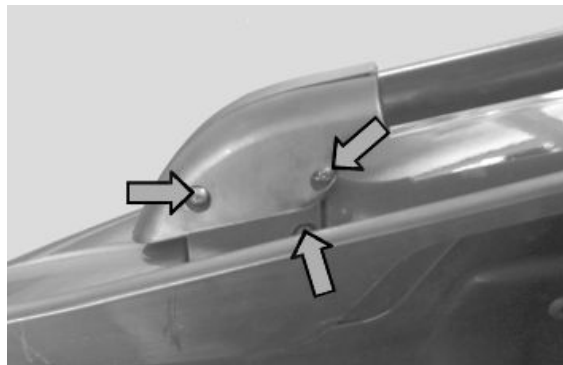

- Undo the seven fixing screws.

- Remove the side fairing by pulling it in order to release the hooks.

---

## License plate holder

- Undo the two upper screws fixing it to the rear plastic element and the three screws fixing it to the frame.

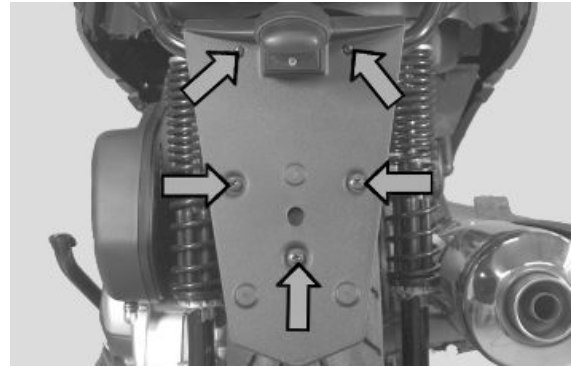

---

## Helmet bay

- Remove the side fairings.
- Remove the side handgrips.
- Remove the central frame cover.
- Undo the two screws on the battery compartment, detach the fuse terminal block, the battery wires and the connector to the diagnostics socket.

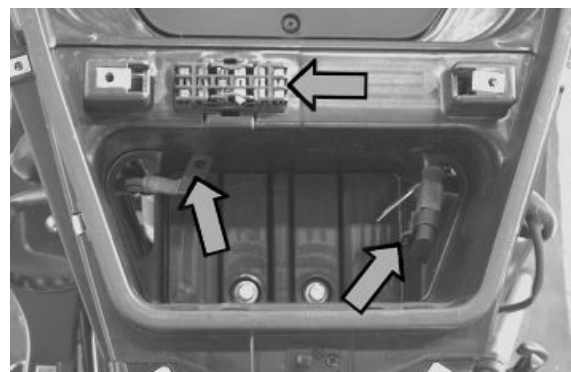

- Disconnect the connectors of the power socket and the helmet compartment light.

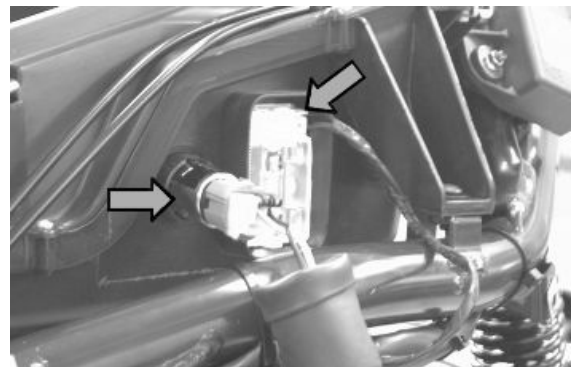

- Undo the screws fixing the helmet compartment light switch to the compartment and disconnect the electrical terminals.

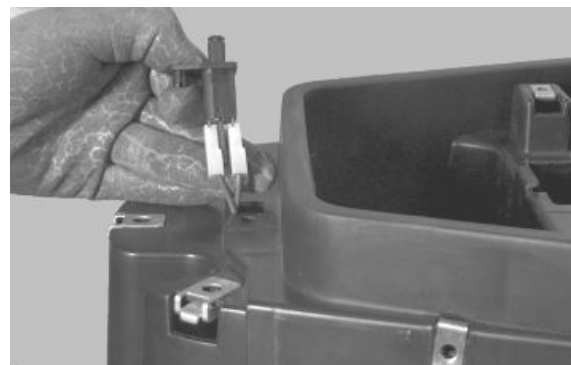

- Undo the screws fixing the voltage regulator to the helmet compartment internal side.

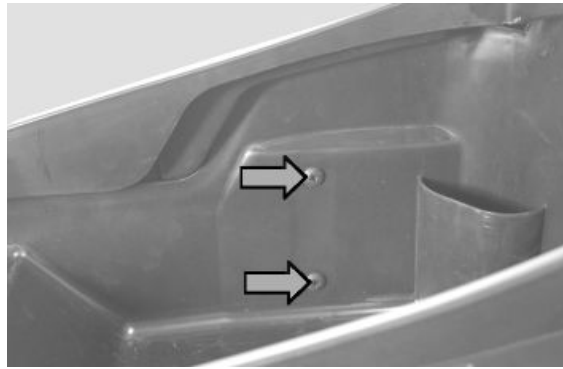

- Undo the two screws of the saddle lock, disconnect the lock cables and release the sheath from the helmet compartment.



- Undo the four screws below the gaskets in the upper part of the compartment.

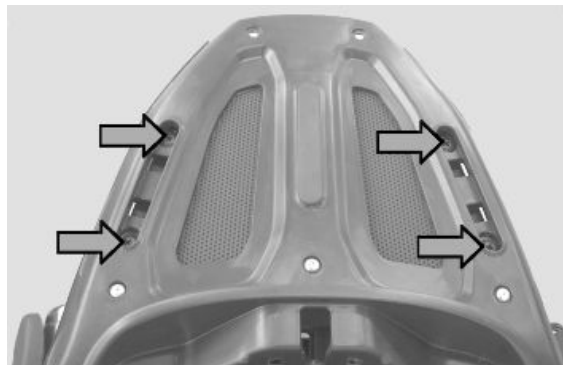

- Undo the three screws fixing it to the frame on both sides.

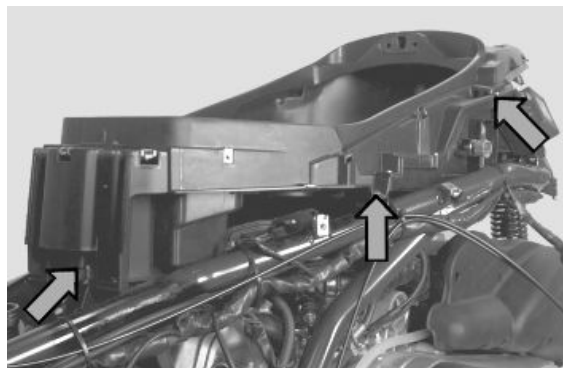

- 
- Remove the helmet compartment.



---

## spoiler

- Remove the GILERA clip-on badge paying attention not to spoil the paint.
- Undo the screw underneath.

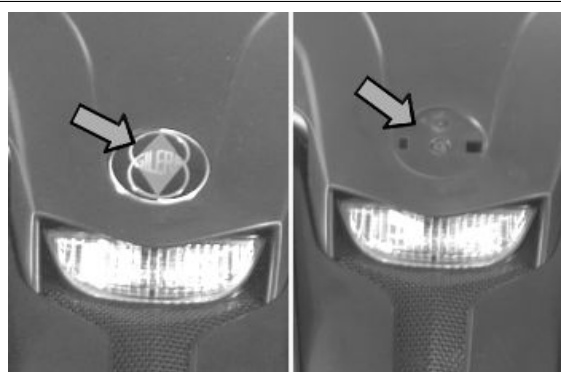

- Undo the four screws indicated.



---

## Fuel tank

- Remove the chassis central cover.
- Remove the footrest.
- Remove the three tank retainers.



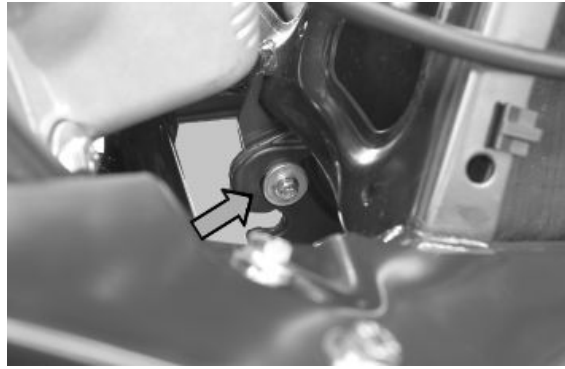

Remove the two lower bracket retainers indicated in the figure.

Disconnect the electric wiring and the fuel pipes.

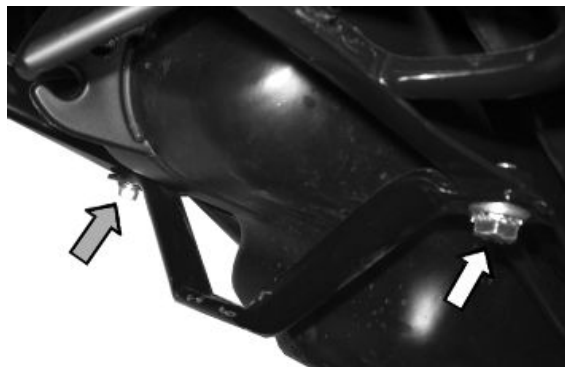

### See also

[Footrest](#)

## Rear

Remove the four fixing screws of the cover and release it from the two leverages.





---

**Handles and top side fairings**

---

- Remove the side fairings.
- Undo the seven screws fixing the turn indicator arrows.



- 
- Disconnect the license plate light connector.



- 
- Undo the three screws indicated at both sides and remove the handgrip clamp.

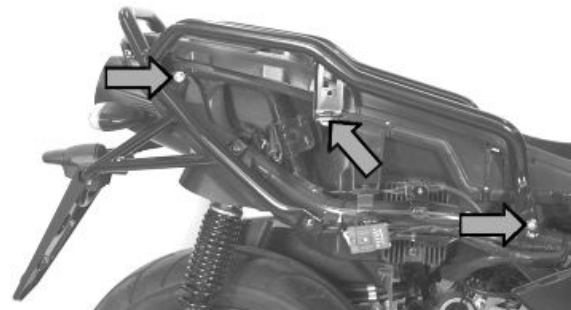

---

**Radiator cover**

---

- Remove the front shield.
- Remove the headlight assembly.
- Disconnect the turn indicators wirings.
- Undo the two screws indicated.

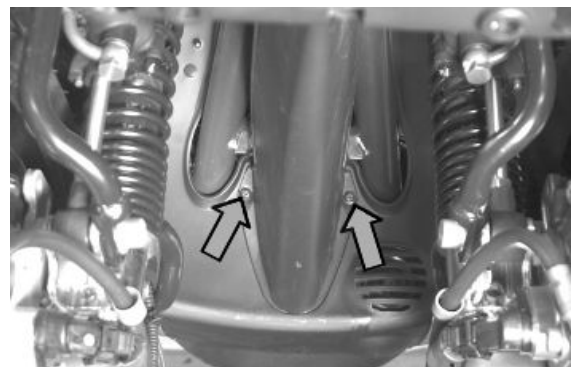

- Undo the two screws indicated.

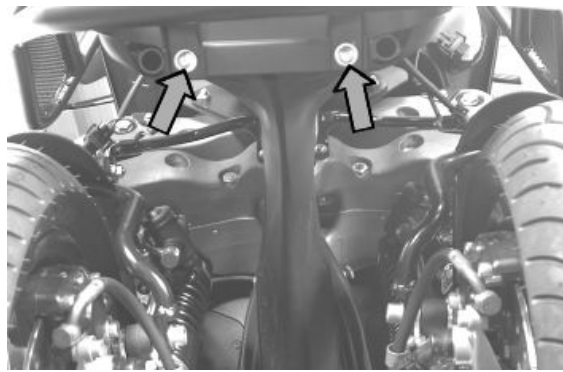

- Undo the two screws of the supporting clamp.

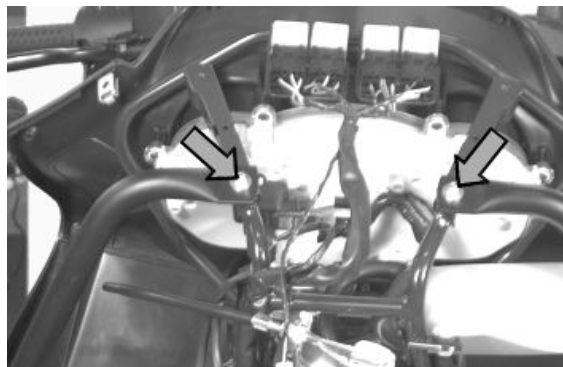

- Remove the supporting clamp.



- Remove the two protective screws that fix the radiator lower protection to the shield back plate. After that, press up and pull the protection front part so as to release it from the radiator frame.



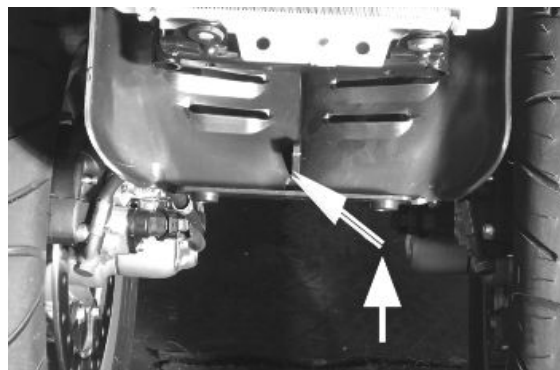

## Battery

- Raise the saddle.
- Undo the two screws of the battery cover.



## Lower cover

### Montaggio

- Dalle viti di corredo prendere: tre viti con rondelle, tre piastrine elastiche e tre distanziali.
- Inserire i distanziali nei tre fori indicati.



- Inserire dove indicato le tre piastrine elastiche.

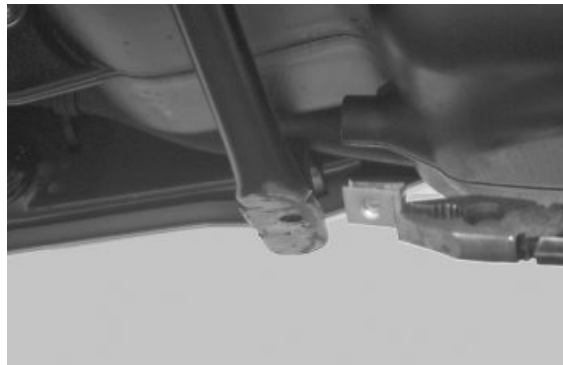
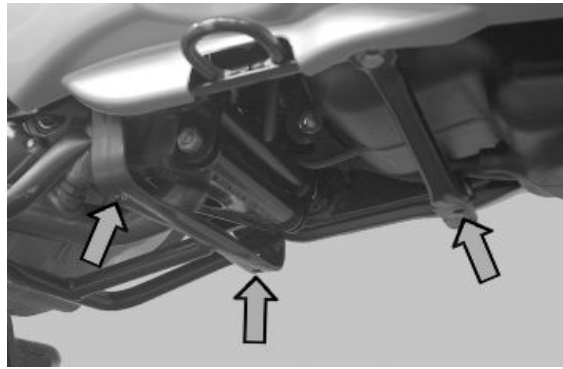

- Montare il paracolpi inferiore, avvitando le tre viti complete di rondelle.

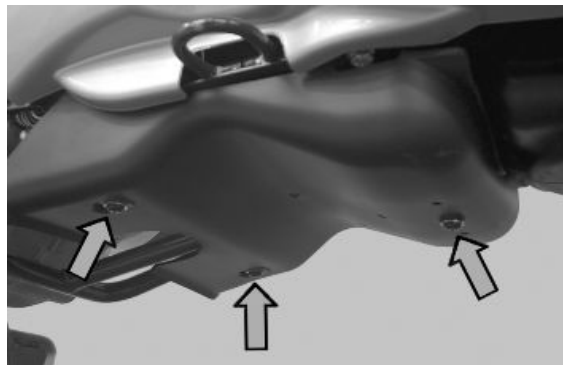

### Smontaggio

- Svitare le tre viti complete di rondelle di fissaggio al telaio, e recuperare il distanziale.

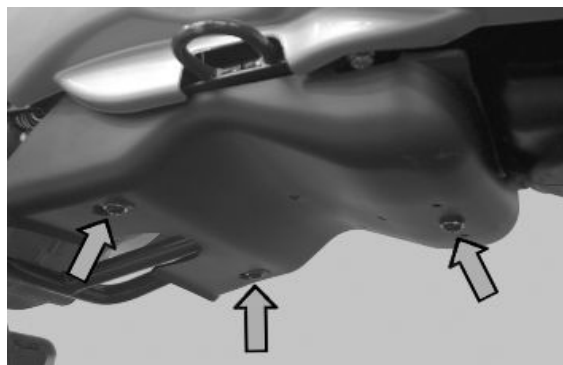





## INDEX OF TOPICS

**P**RE-DELIVERY

**PRE DE**

Carry out the listed tests before delivering the vehicle.

Warning- be very careful when handling fuel.

Position the plastic cover supplied with the coupling on the steering tube as shown in the figure.



If a customer wishes to have mudflaps installed, proceed as follows:

- Place the flap in the mudguard inner side as shown in the figure, making the 4 securing holes coincide.
- Fit the 4 washers on the mudguard outer side and, always on the same side, insert the 4 screws and tighten to the prescribed torque.

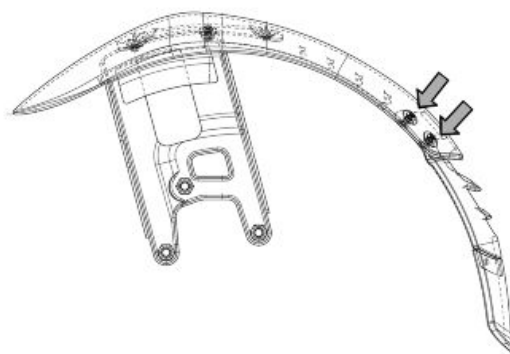

**Locking torques (N\*m)**  
mudflap insert fixing screws 2 ÷ 3

## Aesthetic inspection

### Appearance checks:

- Paintwork
- Fitting of plastics
- Scratches
- Dirt

## Tightening torques inspection

### Lock check

- Safety locks
- clamping screws

### Safety locks

- Rear shock absorber upper fixing
- Rear shock absorber lower fixing



- 
- Front shock absorber upper fixing
  - Front shock absorber lower fixing
  - Sliding stems fixing
  - Break callipers fixing
  - Front wheels fixing screws
  - Front wheels axle nut
  - Rear wheel axle nut
  - Chassis - engine swinging arm fixing
  - Handlebar lock nut
  - Lower ring nut for side steering tubes
  - Upper ring nut for side steering tubes
  - Lower ring nut for central steering tube
  - Upper ring nut for central steering tubes
  - Constant-velocity universal joints

---

## **Electrical system**

- Battery
- Main switch
- Lights: high beams, low beams, side/taillights (front and rear) and relevant warning lights
  - Regulating the headlights according to the regulations currently in force
- Front and rear stop light buttons and bulb
- Turn indicators and their warning lights
- Instrument lighting
- instruments: fuel and temperature indicator
- Instrument panel lights
- Horn
- electric start up
- Engine stopping with emergency stop switch
- Electric opening of saddle with remote control
- Tilting system locking - unlocking button

**CAUTION**

**TO ENSURE MAXIMUM PERFORMANCE, THE BATTERY MUST BE CHARGED BEFORE USE. INADEQUATE CHARGING OF THE BATTERY WITH A LOW LEVEL OF ELECTROLYTE BEFORE IT IS FIRST USED SHORTENS THE LIFE OF THE BATTERY.**

**CAUTION**

**WHEN INSTALLING THE BATTERY, ATTACH THE POSITIVE LEAD FIRST AND THEN THE NEGATIVE LEAD.**

**WARNING**

**BATTERY ELECTROLYTE IS TOXIC AND IT MAY CAUSE SERIOUS BURNS. IT CONTAINS SULPHURIC ACID. AVOID CONTACT WITH EYES, SKIN AND CLOTHING.**

---

**IN CASE OF CONTACT WITH EYES OR SKIN, RINSE WITH ABUNDANT WATER FOR ABOUT 15 MINUTES AND SEEK MEDICAL ATTENTION AT ONCE.**

**IF IT IS SWALLOWED, IMMEDIATELY DRINK LARGE QUANTITIES OF WATER OR VEGETABLE OIL. SEEK IMMEDIATE MEDICAL ATTENTION.**

**THE BATTERIES PRODUCE EXPLOSIVE GAS; KEEP THEM AWAY FROM NAKED FLAMES, SPARKS AND CIGARETTES. IF THE BATTERY IS CHARGED IN A CLOSED PLACE, TAKE CARE TO ENSURE ADEQUATE VENTILATION. ALWAYS PROTECT YOUR EYES WHEN WORKING CLOSE TO BATTERIES.**

**KEEP OUT OF THE REACH OF CHILDREN**

**CAUTION**

**NEVER USE FUSES WITH A CAPACITY HIGHER THAN THE RECOMMENDED CAPACITY. USING A FUSE OF UNSUITABLE RATING MAY SERIOUSLY DAMAGE THE VEHICLE OR EVEN CAUSE A FIRE.**

---

## **Levels check**

### **Level check:**

- Hydraulic brake system liquid level.
  - Tilt locking system fluid level
  - Rear hub oil level
  - Engine coolant level
  - Engine oil level
- 

## **Road test**

### **Test ride**

- Cold start
  - Instrument operations
  - Response to the gas command
  - Stability on acceleration and braking
  - Rear and front brake efficiency
  - Parking brake efficiency
  - Rear and front suspension efficiency
  - Abnormal noise
  - Tilting system locking - unlocking efficiency
- 

## **Static test**

### **Static control after the test ride:**

- Hot engine restart
- Minimum seal (turning the handlebar)
- Uniform steering rotation
- Possible losses
- electric radiator fan operation

**CAUTION**

---

**CHECK AND ADJUST TYRE PRESSURE WITH TYRES AT AMBIENT TEMPERATURE.**

**CAUTION**

**NEVER EXCEED THE RECOMMENDED INFLATION PRESSURES OR TYRES MAY BURST.**

---

## **Functional inspection**

Verifica Funzionale:

- Impianto frenante idraulico: corsa della leva
  - Frizione: verifica corretto funzionamento
  - Motore: verifica corretto funzionamento generale e assenza di rumorosità anomale
  - Altro: verifica documenti, verifica n° di telaio e n° di motore, attrezzi a corredo, montaggio targa, controllo serrature, controllo pressione pneumatici, montaggio specchietti, montaggio paracolpi inferiore ed eventuali accessori
-



# INDEX OF TOPICS

TIME

TIME

This section is devoted to the time necessary to carry out repairs.

For each operation, the description, code and time envisages are specified.

## Engine

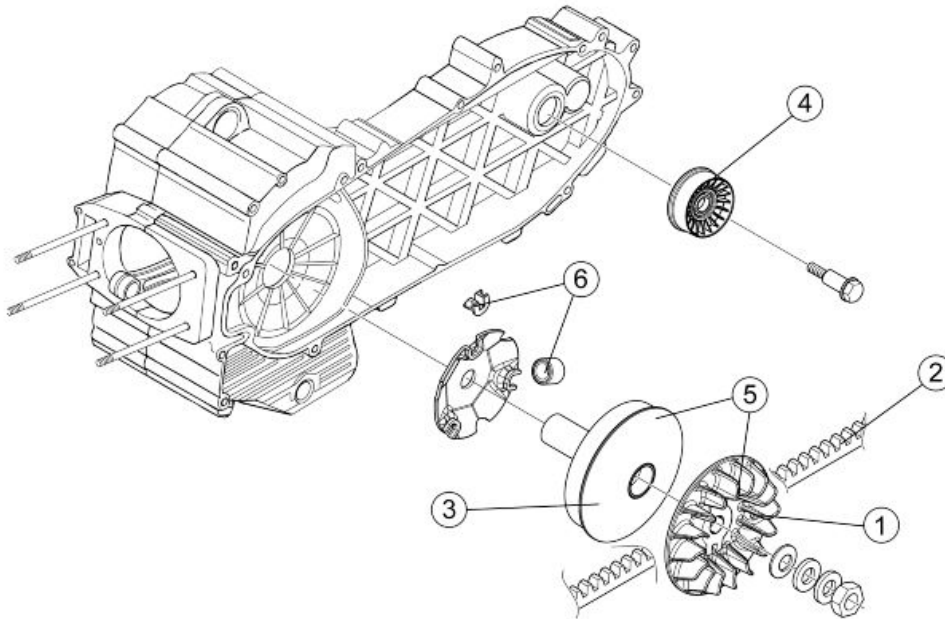

### ENGINE

	<b>Code</b>	<b>Action</b>	<b>Duration</b>
1	001001	Engine to chassis - Replacement	

## Crankcase

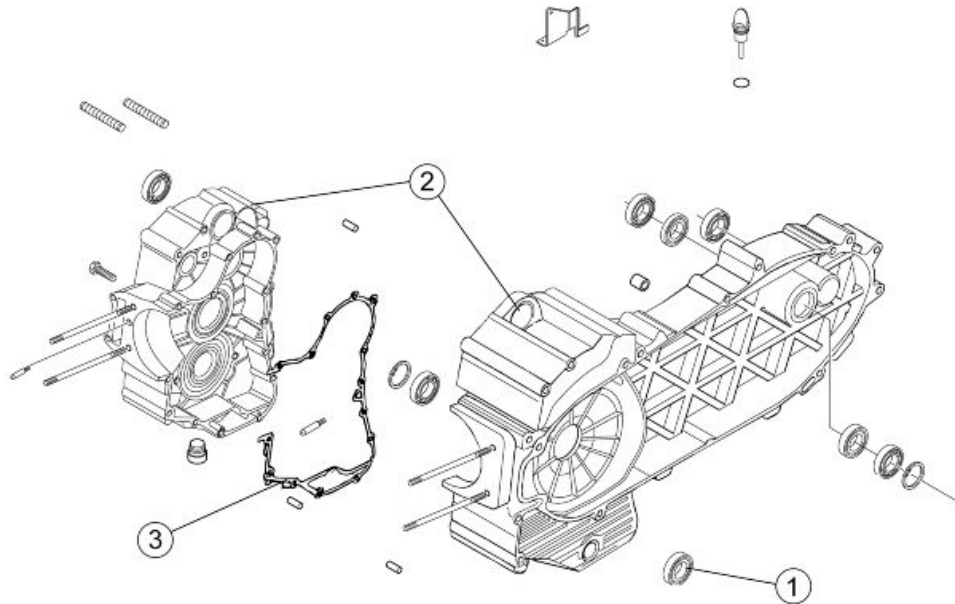
**CRANKCASE**

	<b>Code</b>	<b>Action</b>	<b>Duration</b>
1	001100	Oil seal, clutch side - Replacement	
2	001133	Engine crankcase- Replacement	
3	001153	Half crankcase gasket - Replacement	

## Crankshaft

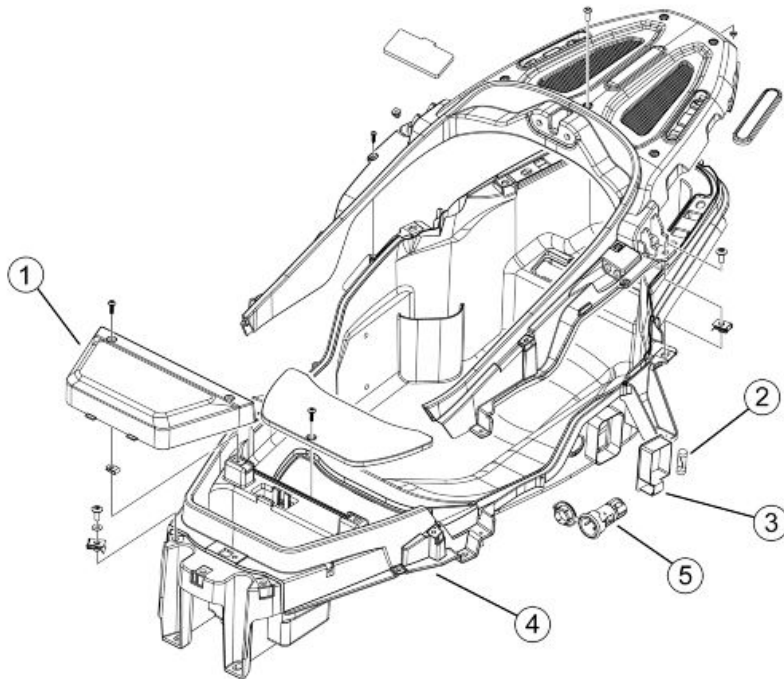

### CRANKSHAFT

	<b>Code</b>	<b>Action</b>	<b>Duration</b>
1	001117	Crankshaft - Replacement	
2	001098	Countershaft - Replacement	

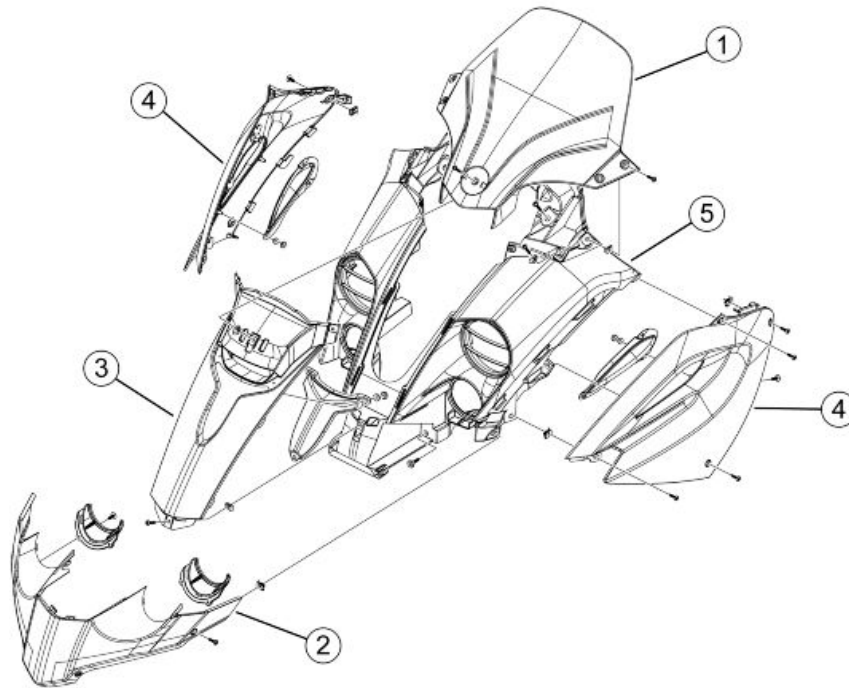

## Cylinder assy.

**CYLINDER GROUP**

	<b>Code</b>	<b>Action</b>	<b>Duration</b>
1	001002	Cylinder piston - Replacement	
2	001154	Pin ring piston unit - Service	
3	001129	Chain tensioner - Service and Replacement	

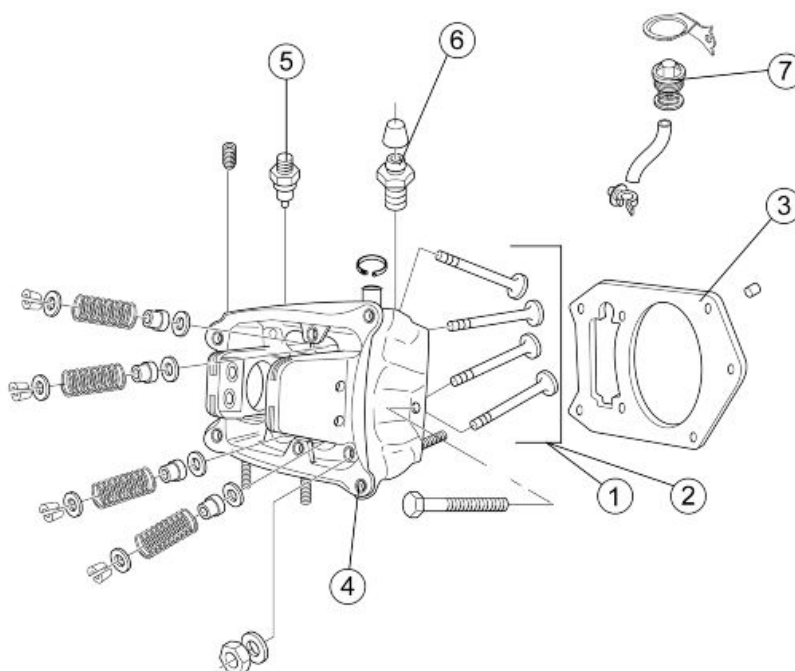
**Cylinder head assy.****GRUPPO TESTA**

	<b>Code</b>	<b>Action</b>	<b>Duration</b>
1	001045	Valves - Replacement	
2	001049	Valves - Adjustments	
3	001056	Head gasket - Replacement	
4	001126	Head - Replacement	
5	001083	Thermistor - Replacement	
6	007012	Coolant bleed valve - Replacement	
7	001057	Thermostat - Replacement	

## Rocker arms support assy.

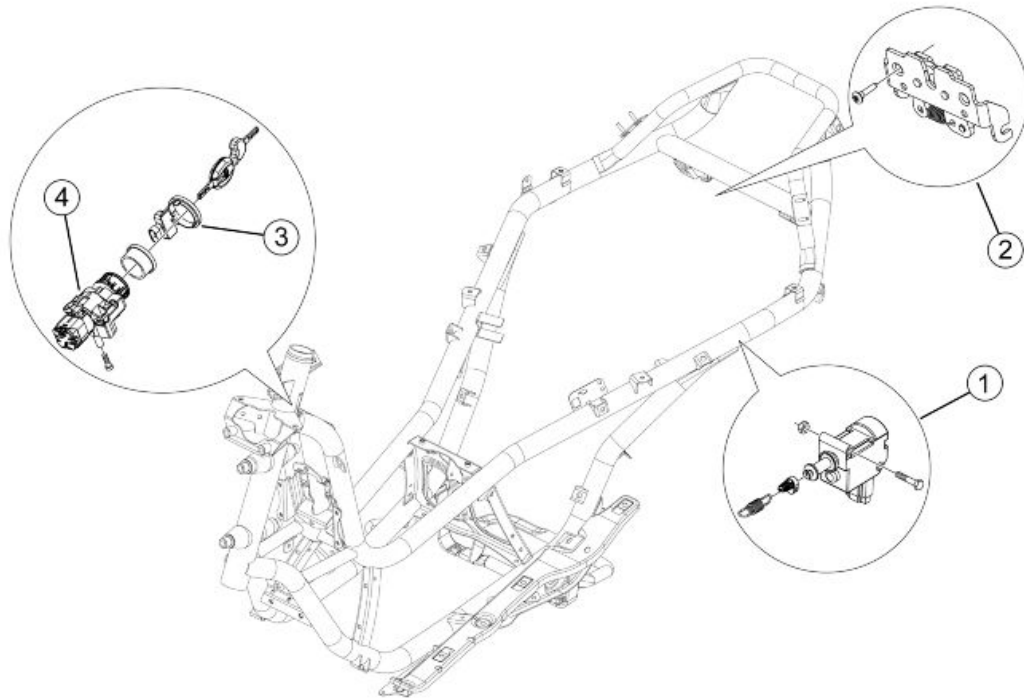
**ROCKING LEVER SUPPORT UNIT**

	<b>Code</b>	<b>Action</b>	<b>Duration</b>
1	001044	Camshaft - Replacement	
2	001148	Rocking lever valve - Replacement	
3	001169	Decompressor - Replacement	

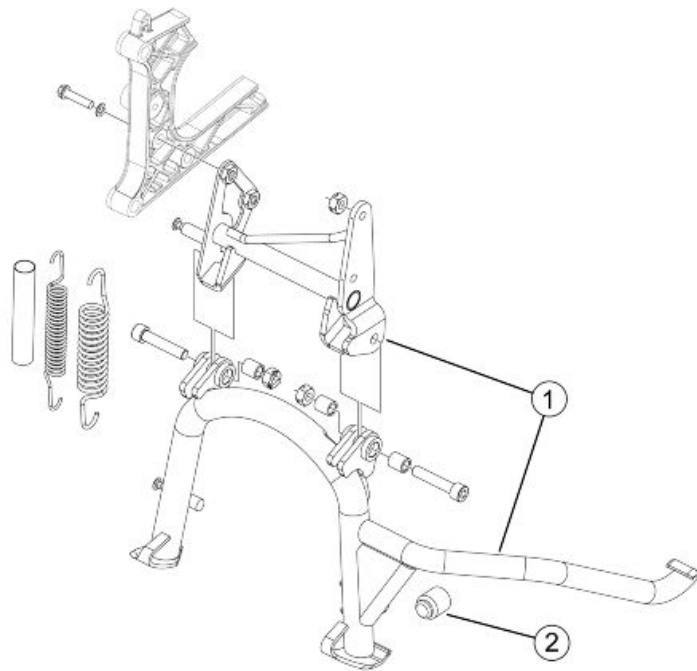
**Cylinder head cover****HEAD COVER**

	<b>Code</b>	<b>Action</b>	<b>Duration</b>
1	001089	Head cover - Replacement	
2	001093	Spark plug - Replacement	
3	001088	Head cover gasket - Replacement	

## Flywheel cover

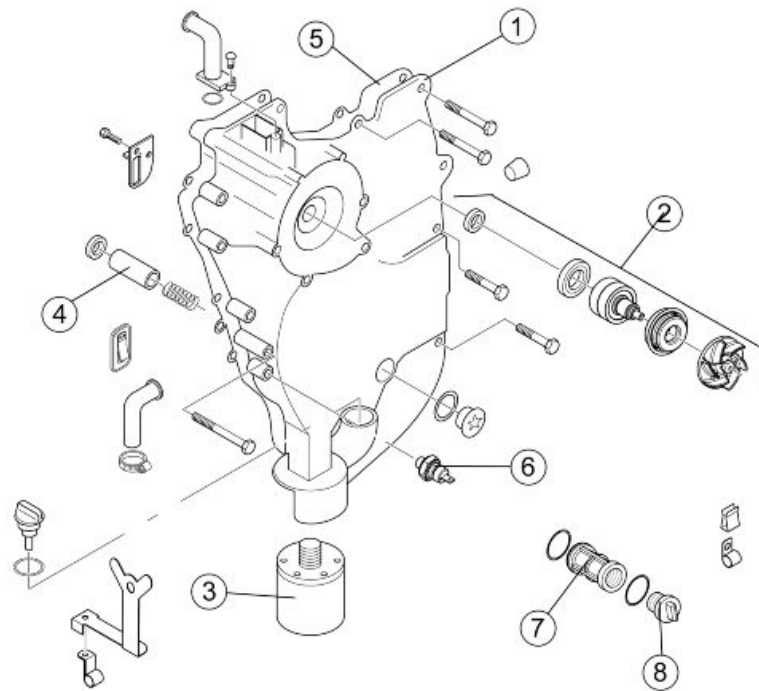
**COPERCHIO VOLANO**

	<b>Code</b>	<b>Action</b>	<b>Duration</b>
1	001087	Flywheel cover - replace	
2	001113	Water pump - Replacement	
3	001123	Oil filter -Replacement	
4	001124	By-pass valve - Replacement	
5	001150	Flywheel cover gasket - Replacement	
6	001160	Minimum oil pressure sensor - Replacement	
7	001102	Net oil filter - Replacement / Cleaning	
8	003064	Engine oil - change	

## Driven pulley

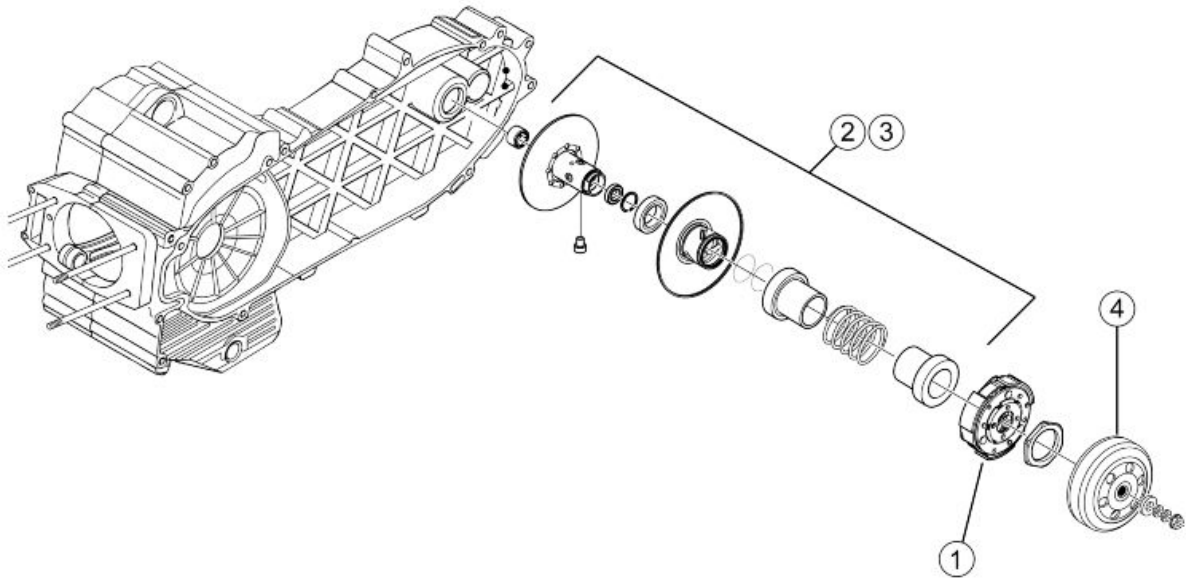

### DRIVEN PULLEY

	Code	Action	Duration
1	001022	Clutch - Replacement	
2	001012	Driven pulley - Overhaul	
3	001110	Driven pulley - Replacement	
4	001155	Clutch bell housing - Replacement	

## Oil pump

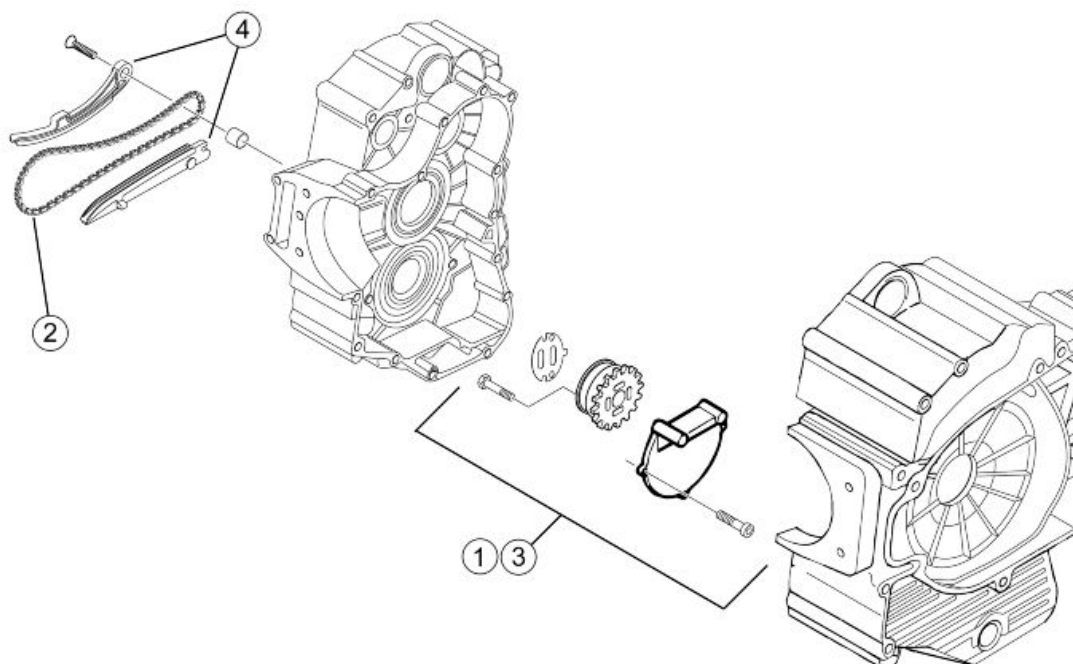
**POMPA OLIO**

	<b>Code</b>	<b>Action</b>	<b>Duration</b>
1	001042	Oil pump - overhaul	
2	001051	Belt/ Timing chain - Replacement	
3	001112	Oil pump - change	
4	001125	Chain guide pads - change	

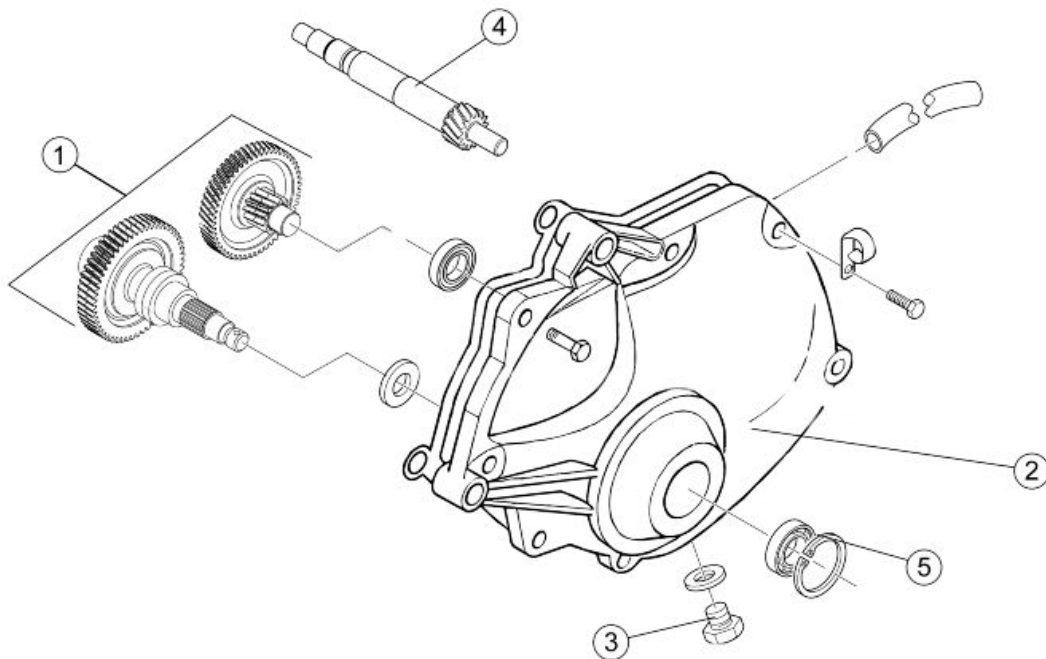
**Final gear assy.****FINAL REDUCTION GEAR ASSEMBLY**

	<b>Code</b>	<b>Action</b>	<b>Duration</b>
1	001010	Geared reduction unit - Service	
2	001156	Gear reduction unit cover - Replacement	
3	003065	Gear box oil - Replacement	
4	004125	Rear gear shaft - Replacement	
5	002031	Rear wheel hub bearings - Replacement	

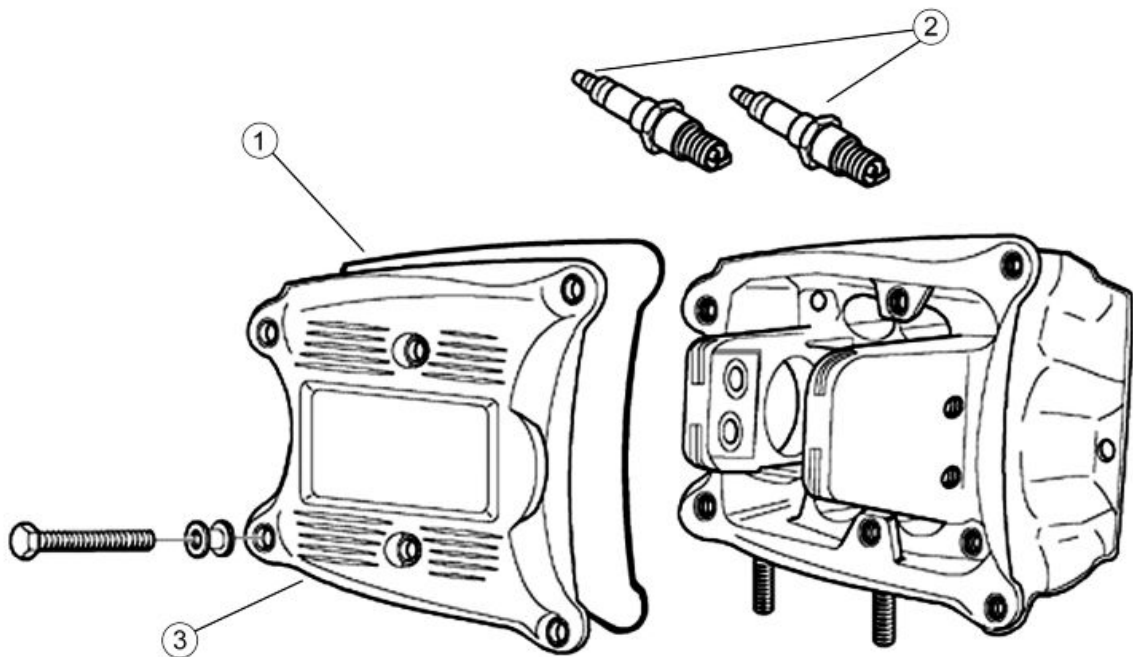

## Driving pulley

**DRIVING PULLEY**

	<b>Code</b>	<b>Action</b>	<b>Duration</b>
1	001086	Driving half-pulley - Replacement	
2	001011	Driving belt - Replacement	
3	001006	driving pulley - Service	
4	001141	Belt anti-flapping roller - Replacement	
5	001066	driving pulley - Replacement	
6	001177	Variator rollers / shoes - Replacement	

## Transmission cover

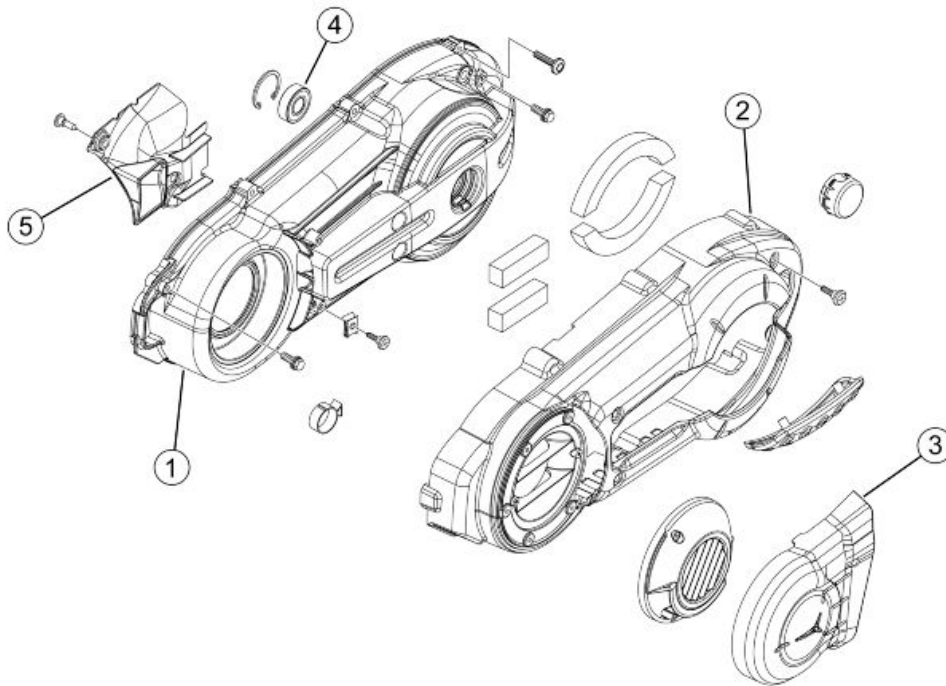

### TRANSMISSION COVER

	Code	Action	Duration
1	001065	Internal transmission cover - Replacement	
2	001096	External transmission cover - Replacement	
3	001131	Transmission air intake - Replacement	
4	001135	Transmission cover bearing - Replacement	
5	001170	Air manifold - replacement	

## Flywheel magneto

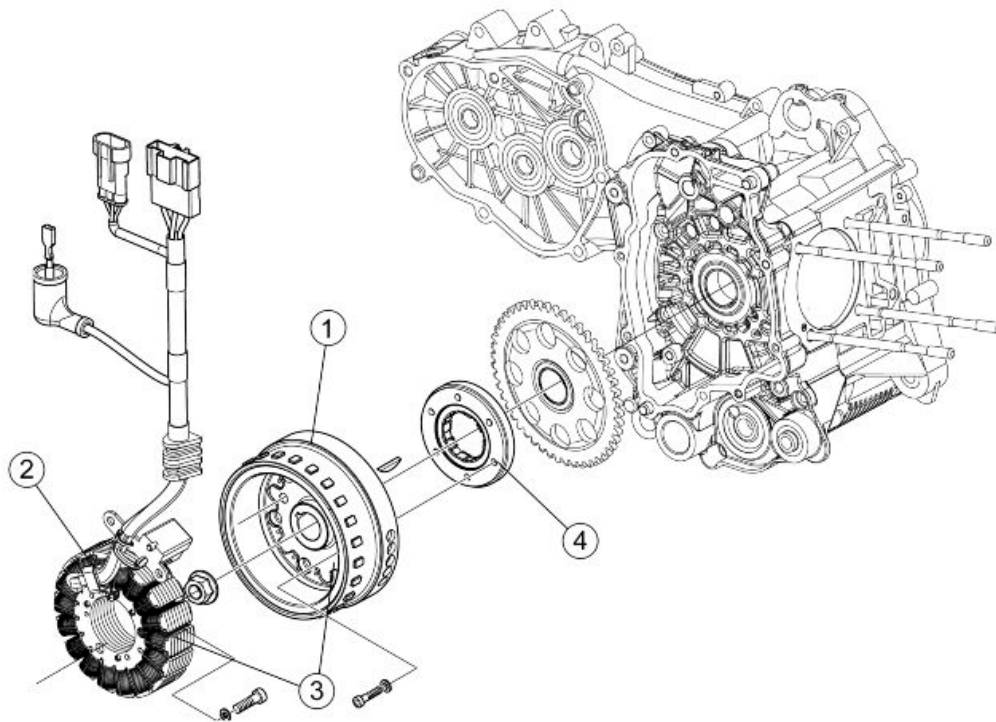
**VOLANO MAGNETE**

	<b>Code</b>	<b>Action</b>	<b>Duration</b>
1	001173	Rotor - replace	
2	001067	Stator - Replacement	
3	001058	Flywheel - Replacement	
4	001104	Start-up freewheel - Replacement	

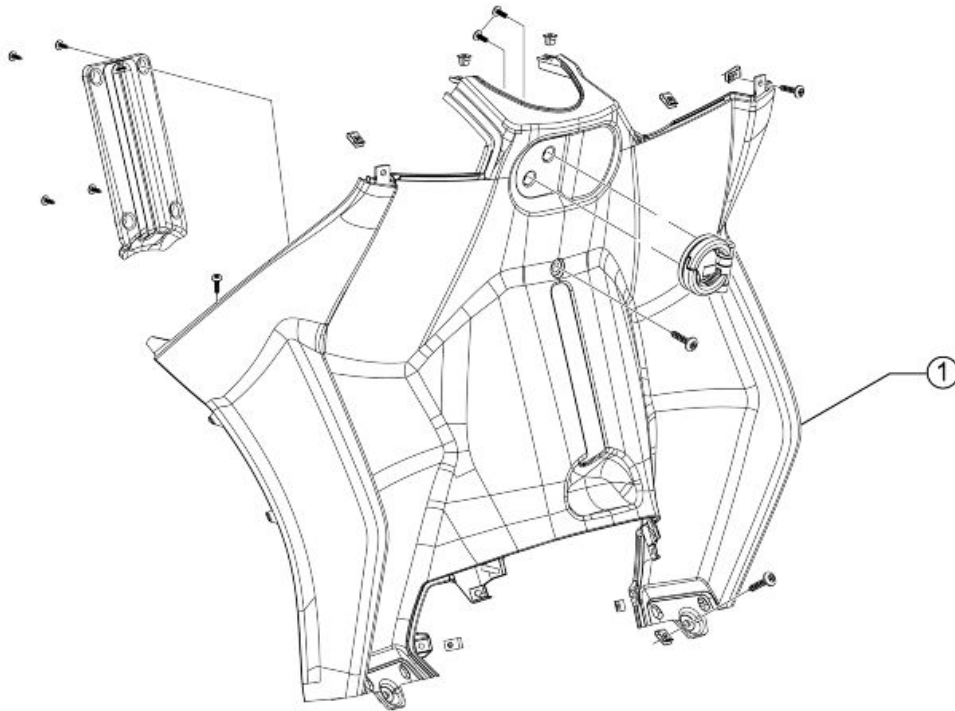
**Butterfly valve****THROTTLE BODY**

	<b>Code</b>	<b>Action</b>	<b>Duration</b>
1	001013	Intake manifold - change	
2	001047	Injector - Replacement	
3	001023	Control unit - Replacement	

## Exhaust pipe

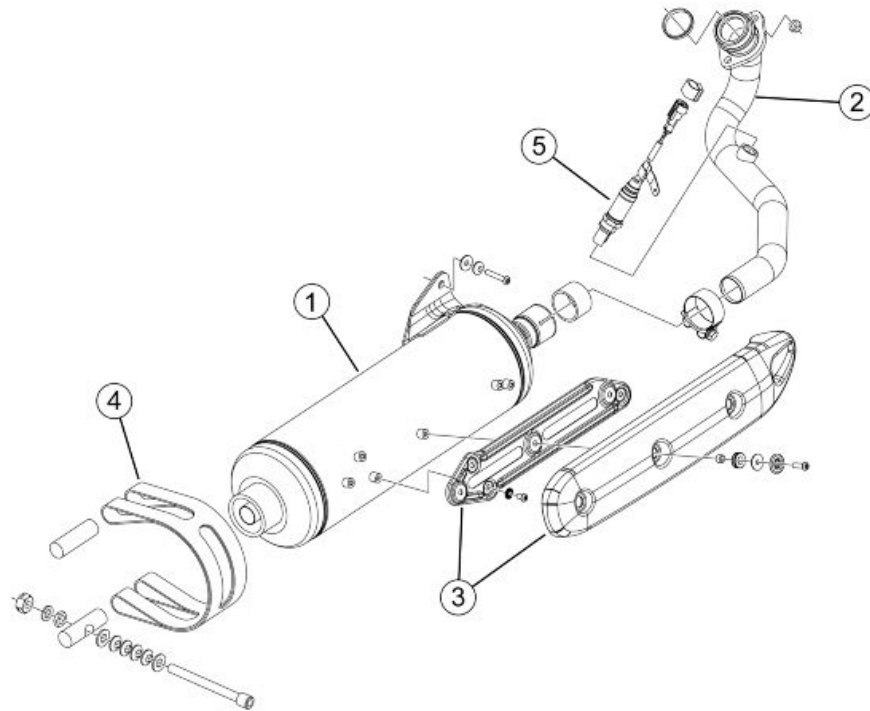
**MUFFLER**

	<b>Code</b>	<b>Action</b>	<b>Duration</b>
1	001009	Muffler - Replacement	
2	001092	Exhaust manifold - Replacement	
3	001095	Muffler guard - Replacement	
4	004169	Muffler guard - Replacement	
5	005138	Lambda probe - Replacement	

## Air cleaner

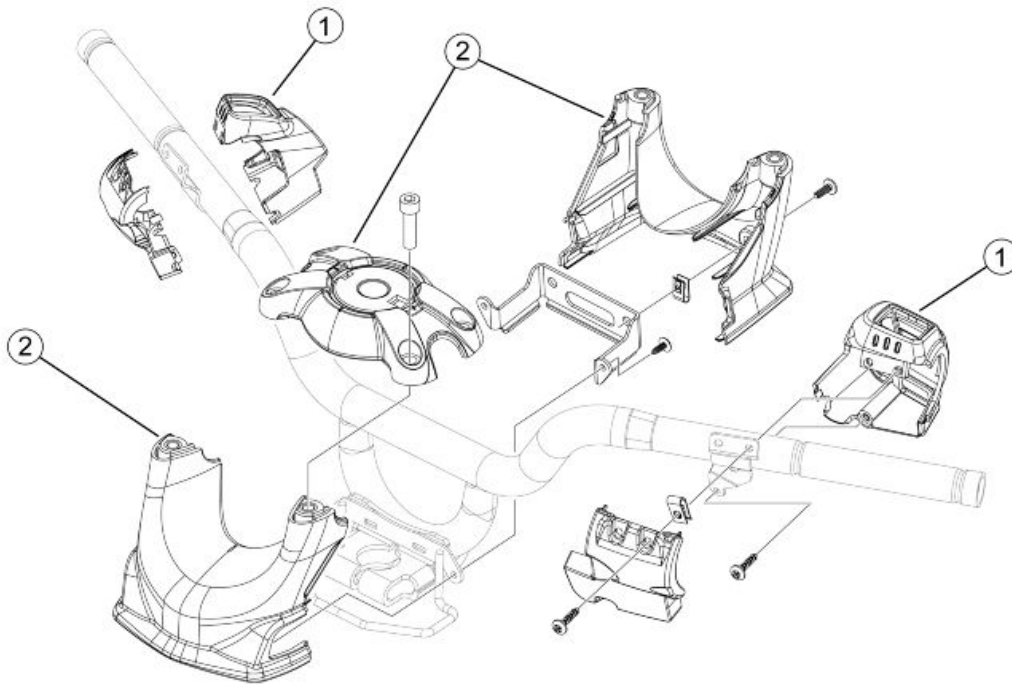

### **DEPURATORE ARIA**

	<b>Code</b>	<b>Action</b>	<b>Duration</b>
1	001015	Air filter box - Replacement	
2	001014	Air filter - Replacement / cleaning	
3	004122	Cleaner / Throttle body union - Replacement	
4	001027	Body / air cleaner union - Re- placement	

## Frame

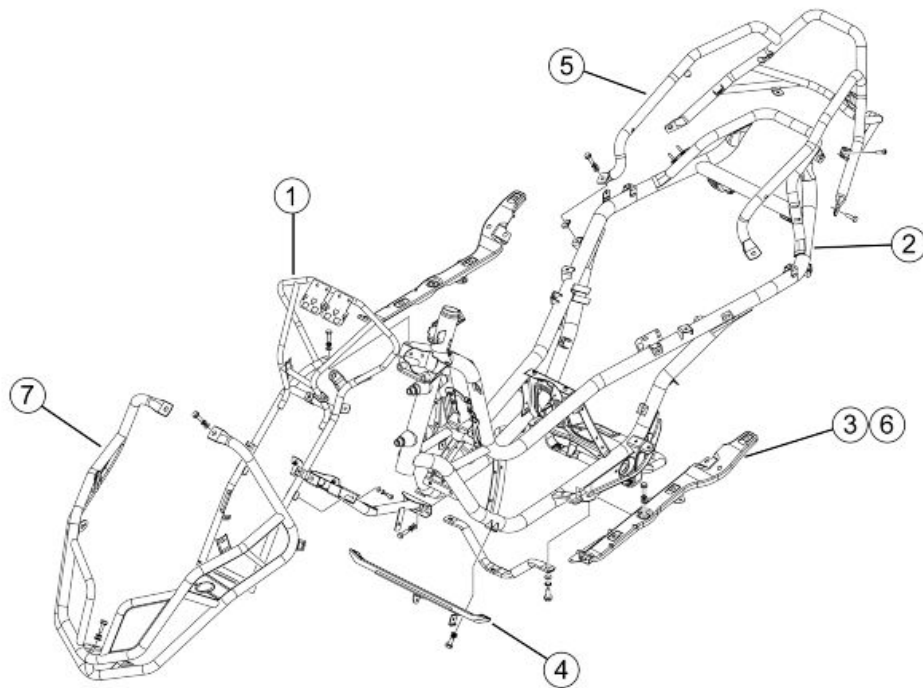

### CHASSIS

	Code	Action	Duration
1	004146	Front frame - Replacement	
2	004001	Frame - replace	
3	004147	footboard support bracket one side - Replacement	
4	004143	Footrest support - replace	
5	004116	Rear frame - Replacement	
6	004148	footboard support bracket two sides - Replacement	
7	902003	Supporto fanale anteriore - Sostituzione	

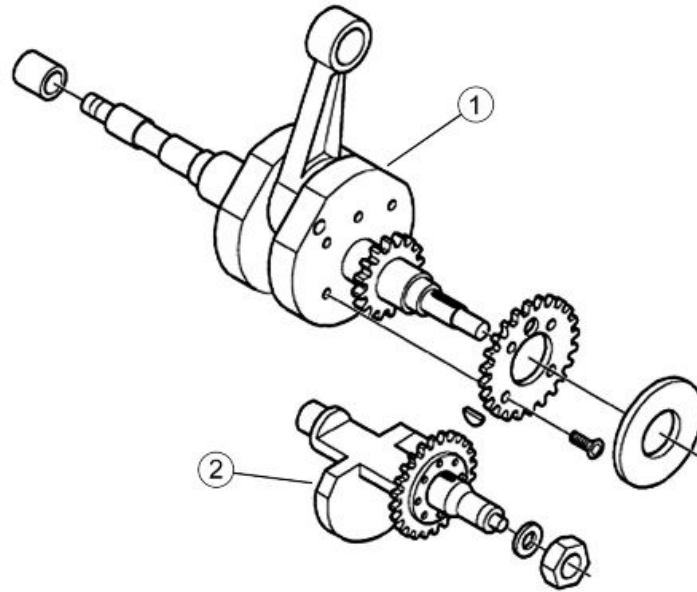
**Centre-stand****STAND**

	<b>Code</b>	<b>Action</b>	<b>Duration</b>
1	004004	Stand - Replacement	
2	004179	Stand buffer - Replacement	

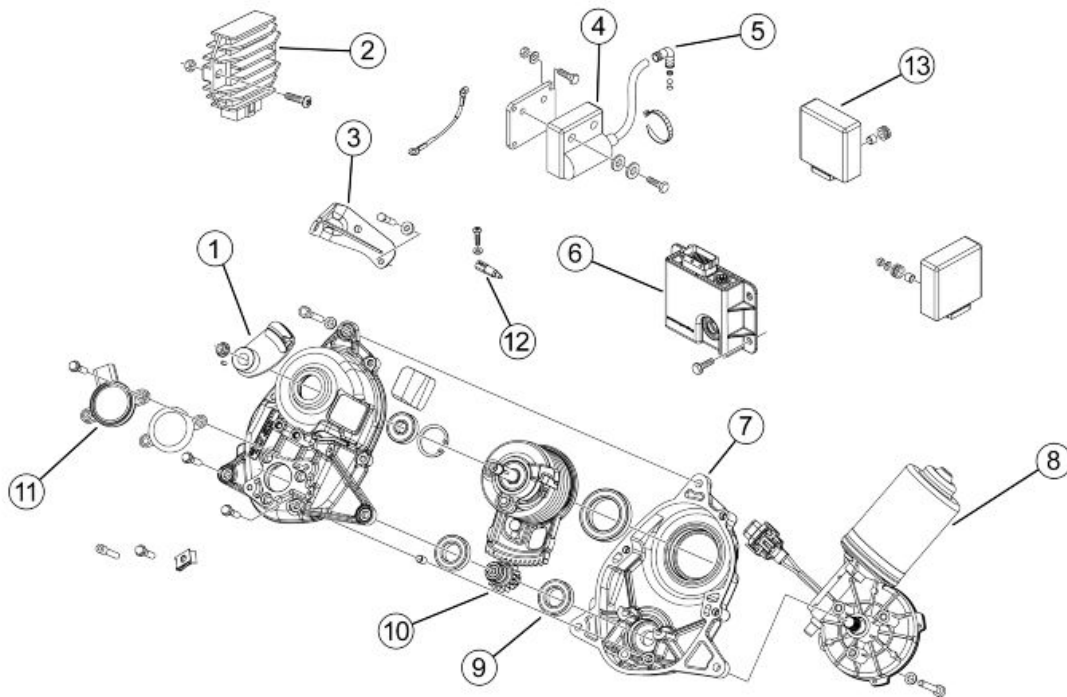

## Legshield spoiler

**FRONT SHIELD**

	<b>Code</b>	<b>Action</b>	<b>Duration</b>
1	004021	Shield upper section - Replacement	
2	004022	Shield lower section - Replacement	
3	004020	Headlight rim - Replacement	
4	004085	Fairing (1) - Replacement	
5	004064	Front shield - Replacement	

## Side fairings

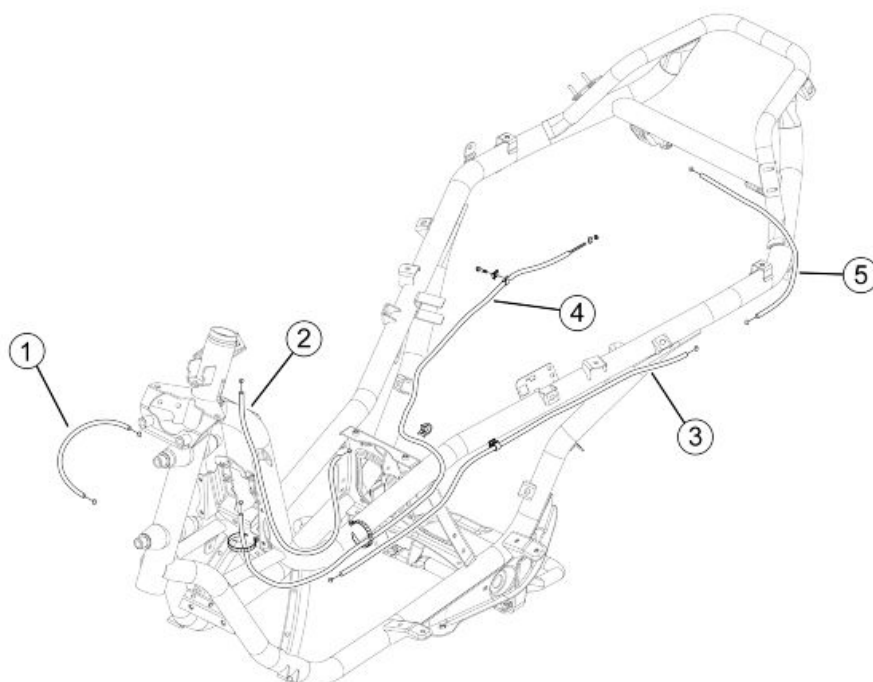

### COPERTURE LATERALI

	Code	Action	Duration
1	004036	Lower chassis cover - Replacement	
2	004129	Rear fairing - Replacement	
3	004037	Side aprons-Replacement	
4	004121	Fianchetto sella (1) - Sostituzione	

## Rear cover

### SCUDO POSTERIORE

	Code	Action	Duration
1	004065	Front shield rear section - removal and installation	

## Central cover

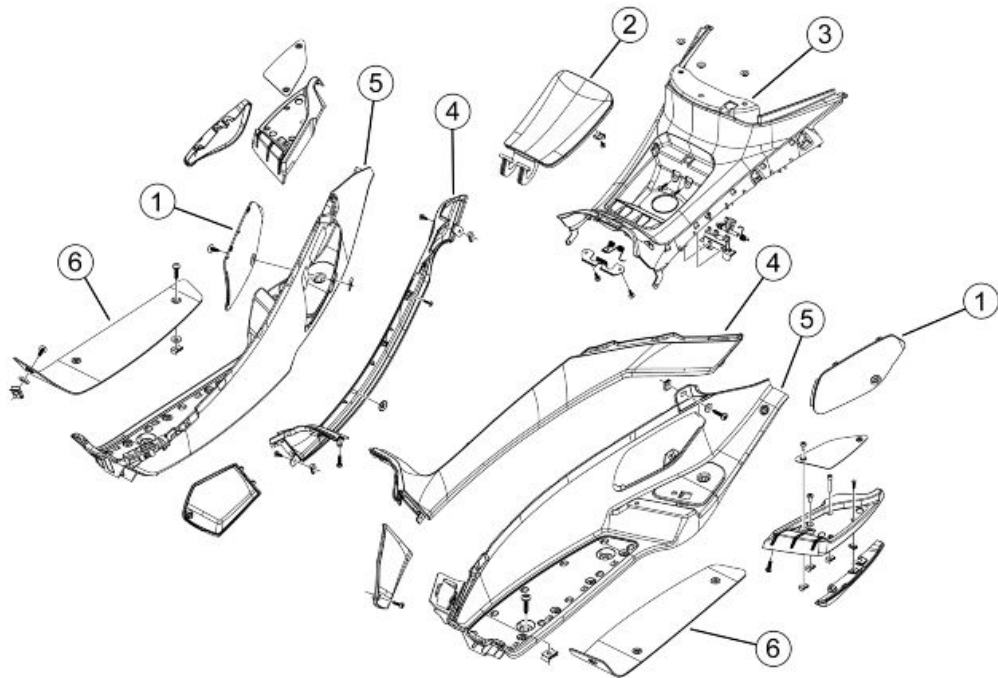

### CENTRAL COVER

	<b>Code</b>	<b>Action</b>	<b>Duration</b>
1	004059	Spark plug inspection flap - Replacement	
2	004135	Fuel tank port - Replacement	
3	004011	Central chassis cover - replace	
4	004012	Rear fairings - Removal and refitting	
5	004015	Footrest - Removal and Refitting	
6	004075	Front mat - Replacement	

## Mudguard

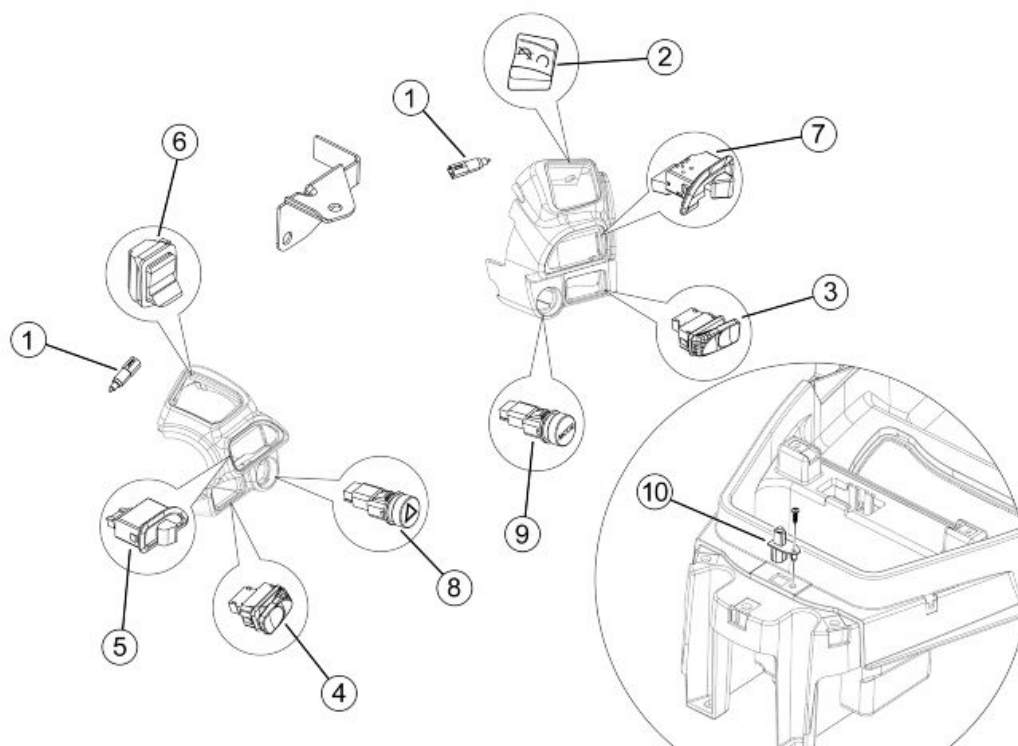

### MUDGUARDS

	Code	Action	Duration
1	007015	Radiator air intake - Replacement	
2	004009	Rear mudguard - Replacement	
3	004181	Lower cover - Replacement	
4	004184	Front mudguard support - replacement	
5	004002	Front mudguard - Replacement	

## Fuel tank

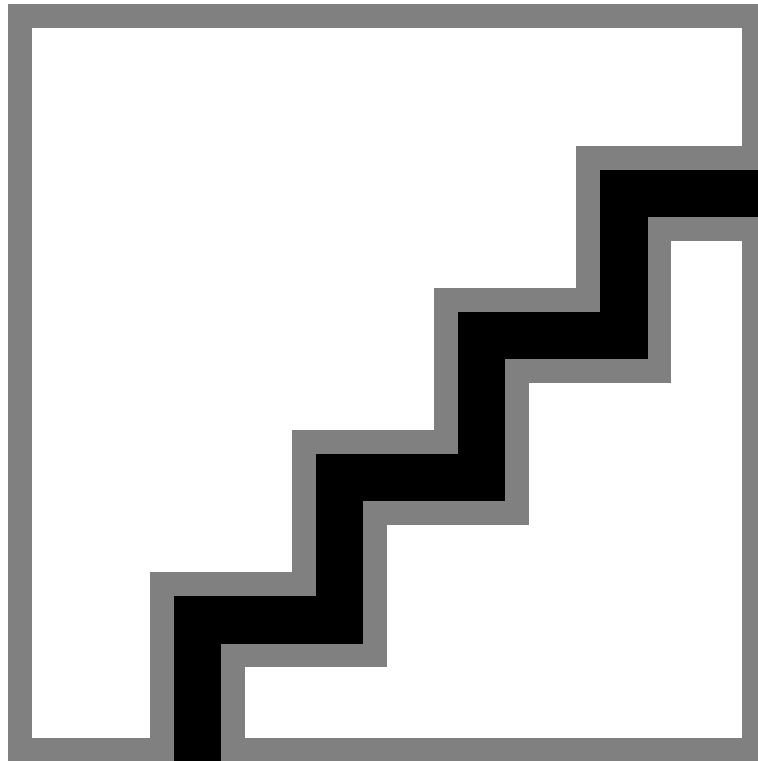
**FUEL TANK**

	<b>Code</b>	<b>Action</b>	<b>Duration</b>
1	004137	Injector pump pipe - Replacement	
2	005010	Tank float - Replacement	
3	004109	Fuel tank breather - change	
4	004168	Fuel tank cap - Replacement	
5	004005	Fuel tank - Replacement	
6	004073	Fuel pump - Replacement	

## Rear shock-absorber

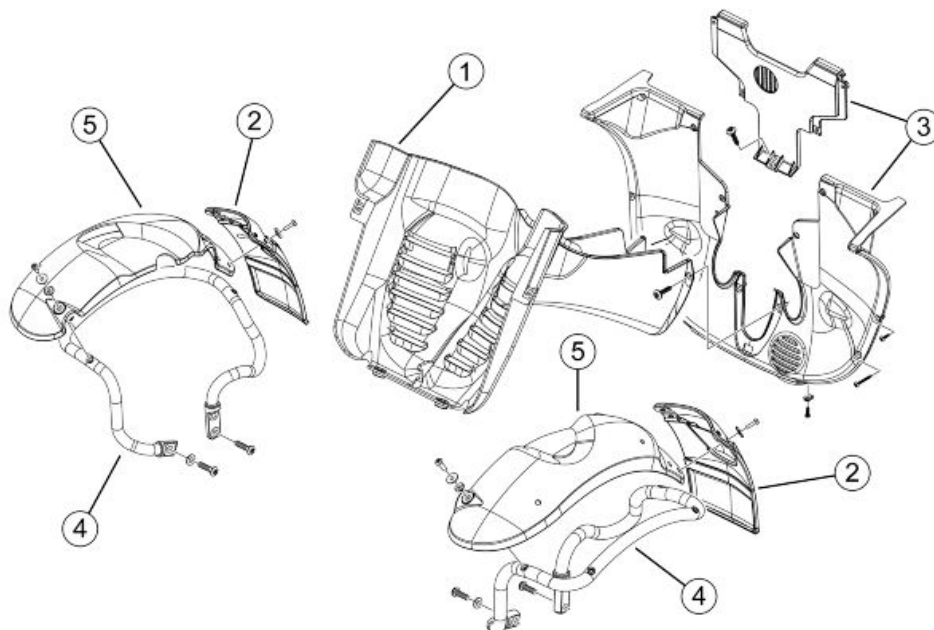

### REAR SHOCK ABSORBERS

	Code	Action	Duration
1	003007	Rear shock absorber - Removal and Refitting	
2	003035	Shock absorber support and brake calliper - Replacement	
3	003077	muffler/rear shock absorber support arm - Service	

Handlebar covers

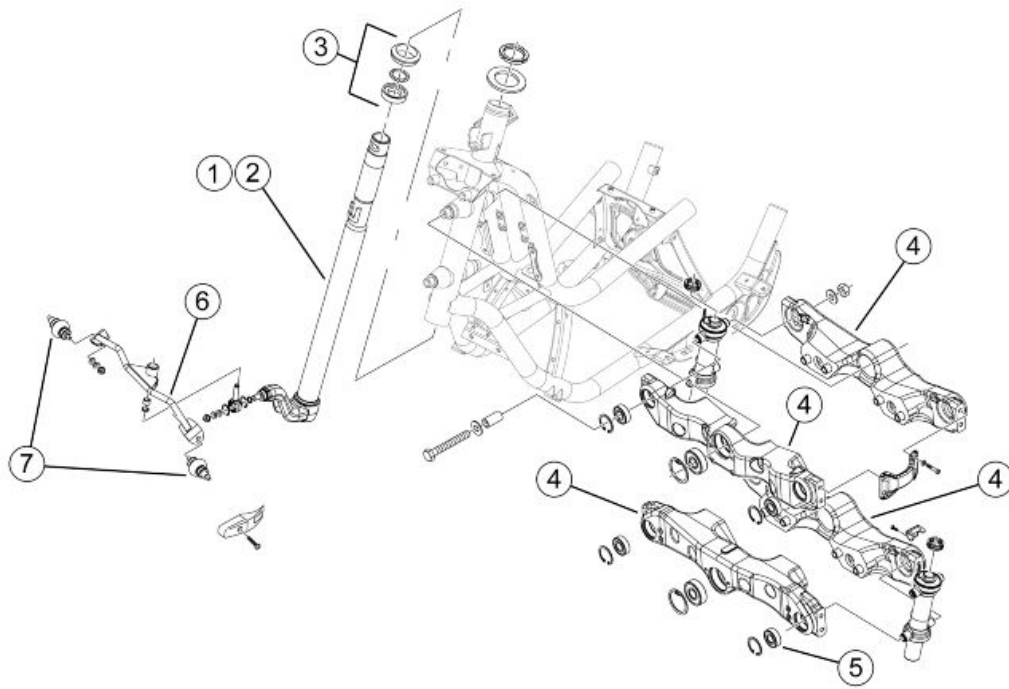

**HANDLEBAR COVERS**

	<b>Code</b>	<b>Action</b>	<b>Duration</b>
1	000307	RIGHT OR LEFT CONTROL ASSEMBLY REPLACEMENT	
2	004026	Handlebar cover - Replacement	

## Handlebar components

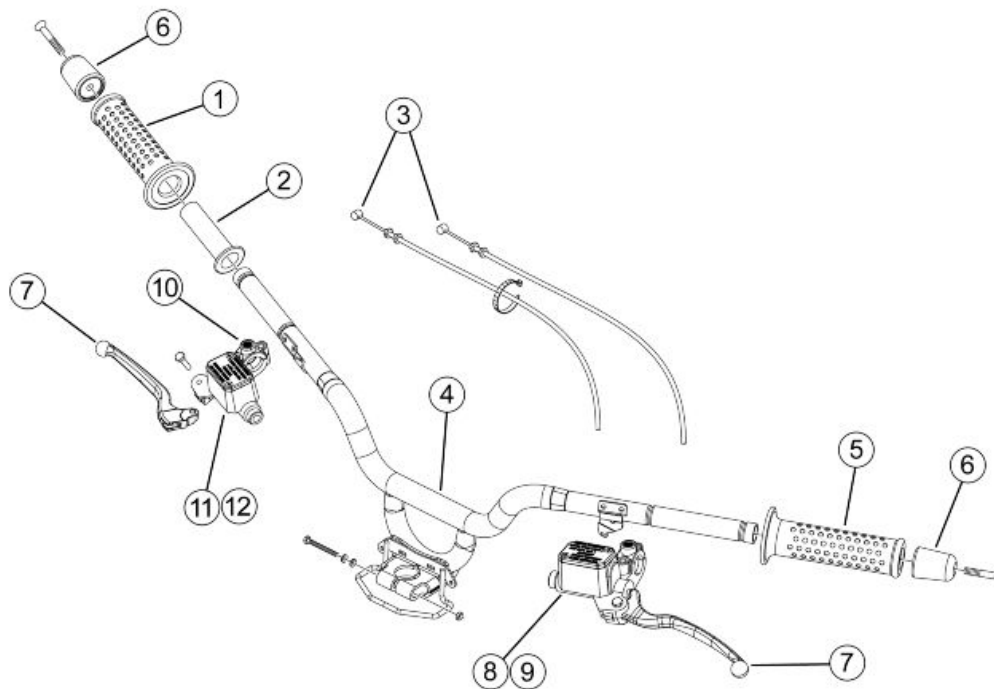

### COMPONENTI MANUBRIO

	<b>Code</b>	<b>Action</b>	<b>Duration</b>
1	002059	Right-hand knob - change	
2	002060	Complete gas command - Replacement	
3	002063	Complete gas transmission - Replacement	
4	003001	Handlebar - Replacement	
5	002071	LHS knob - Replacement	
6	003059	Counterweight - Replacement	
7	002037	Brake lever - Replacement	
8	002067	Rear brake pump - Replacement	
9	002080	Rear brake oil bleeding system - Replacement	
10	004162	Mirror support and/or brake pump fitting u-bolt - Replacement	
11	002024	Front brake pump - replace	
12	002047	Front brake fluid and air bleeding system - Replacement	



## Swing-arm

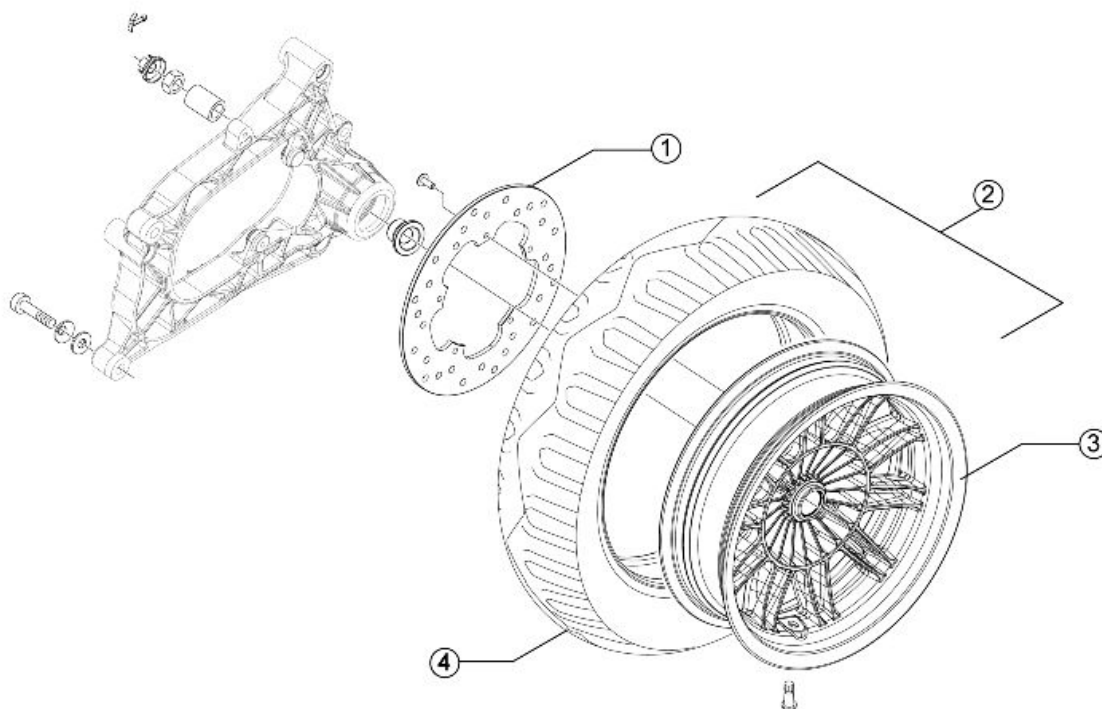

### **SWINGING ARM**

	<b>Code</b>	<b>Action</b>	<b>Duration</b>
1	004058	Silent block - Replacement	
2	003081	Swinging arm support flange - replace	
3	001072	Swinging arm - Engine-chassis connection - Replacement	
4	003080	Swinging arm on frame - Re- placement	

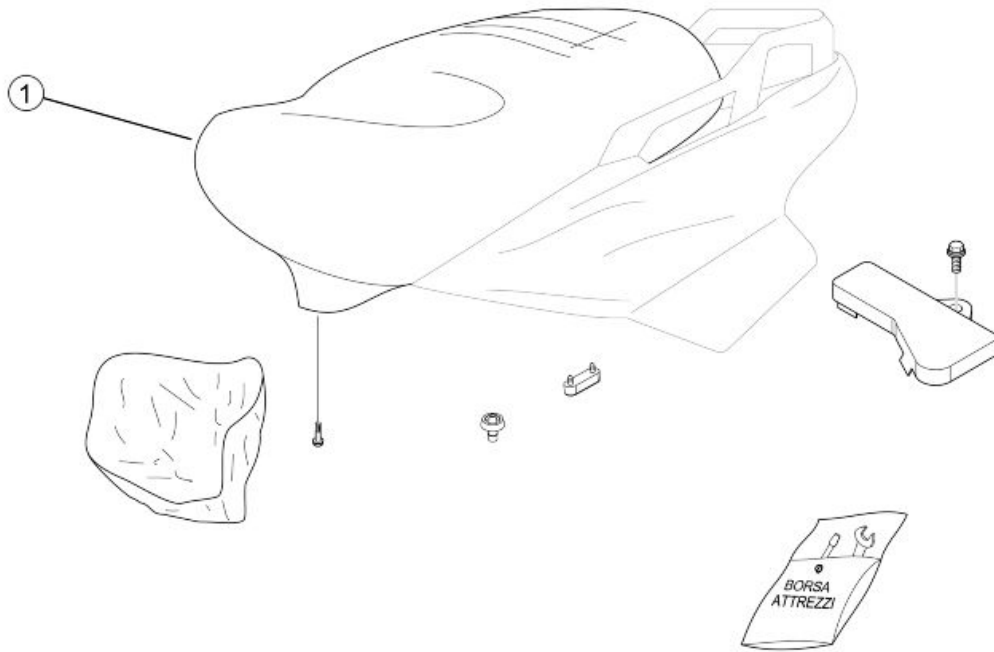
**Seat****SADDLE**

	<b>Code</b>	<b>Action</b>	<b>Duration</b>
1	004003	Saddle - Replacement	

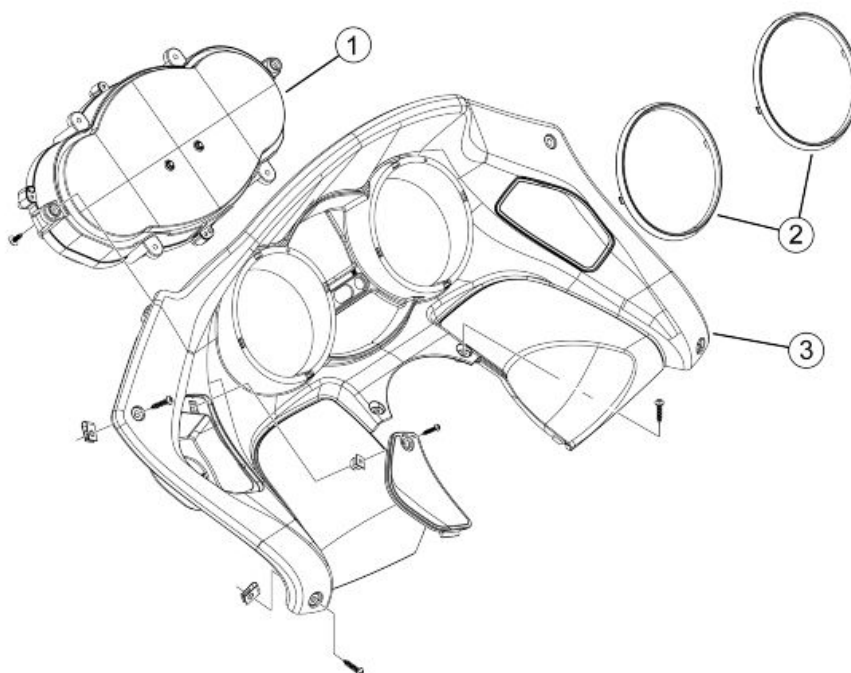
**Instrument panel****GRUPPO STRUMENTI**

	<b>Code</b>	<b>Action</b>	<b>Duration</b>
1	005014	Odometer - Replacement	
2	004099	Odometer housing - Replacement	
3	004035	Instrument panel - Replacement	

## Locks

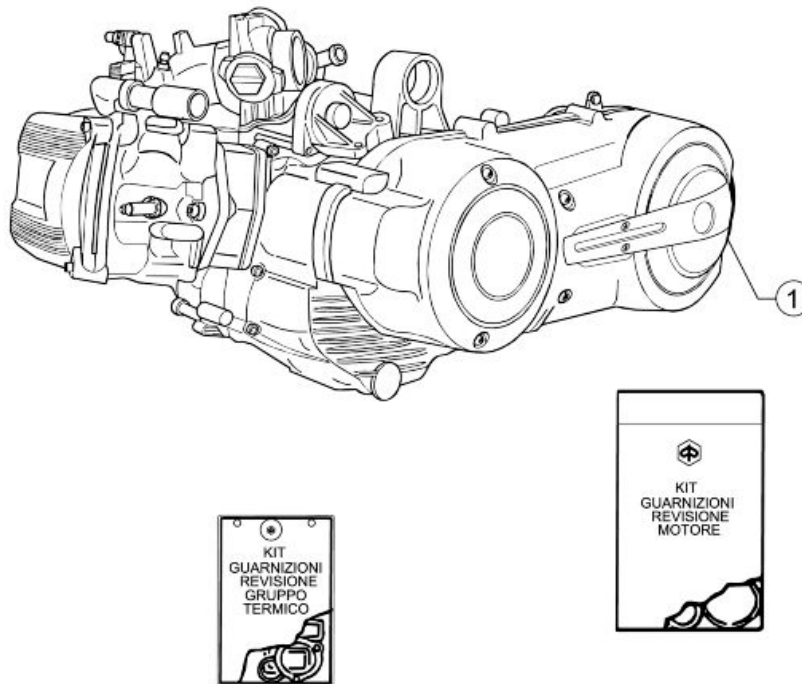

### LOCKS

	Code	Action	Duration
1	005146	Elettroattuatore apertura sella - Sostituzione	
2	004054	Saddle lock catch - Replacement	
3	005072	Immobilizer aerial - Replacement	
4	004010	Anti-theft lock - Replacement	

## Turn signal lights

Front lights

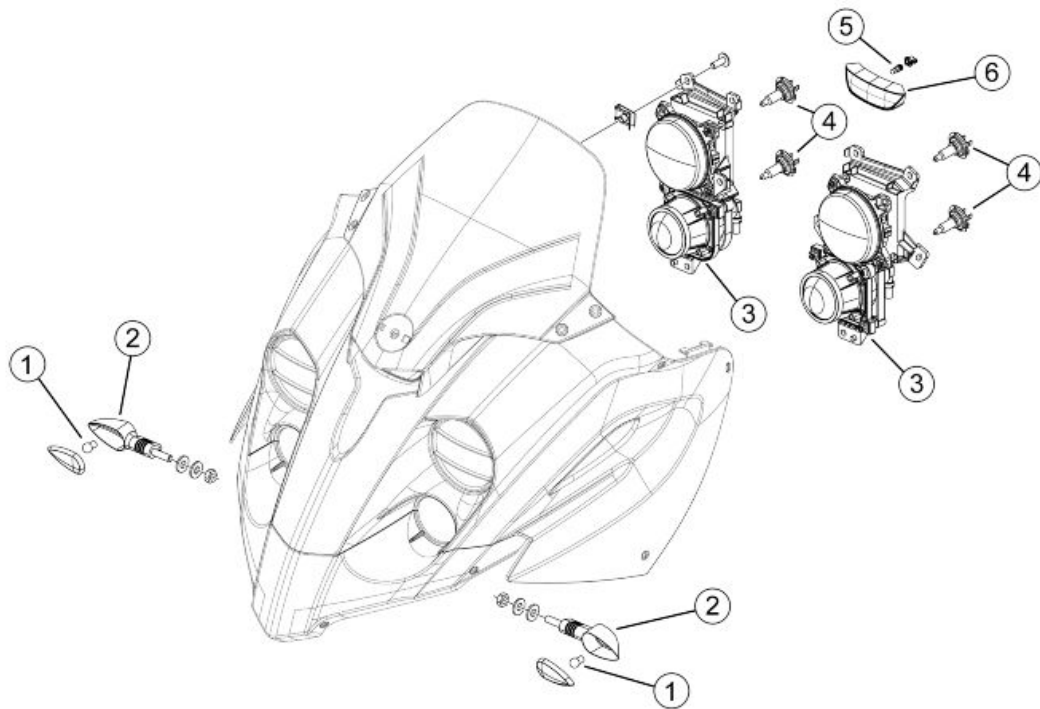

**FANALERIA LAMPEGGIATORI ANT**

	<b>Code</b>	<b>Action</b>	<b>Duration</b>
1	005067	Front direction indicator bulb - Replacement	
2	005012	Front direction indicators - Replacement	
3	005002	Front light - Replacement	
4	005008	Light bulbs - Replacement	
5	005139	Tail light bulb - Replacement	
6	005140	Front light - Replacement	

Rear lights

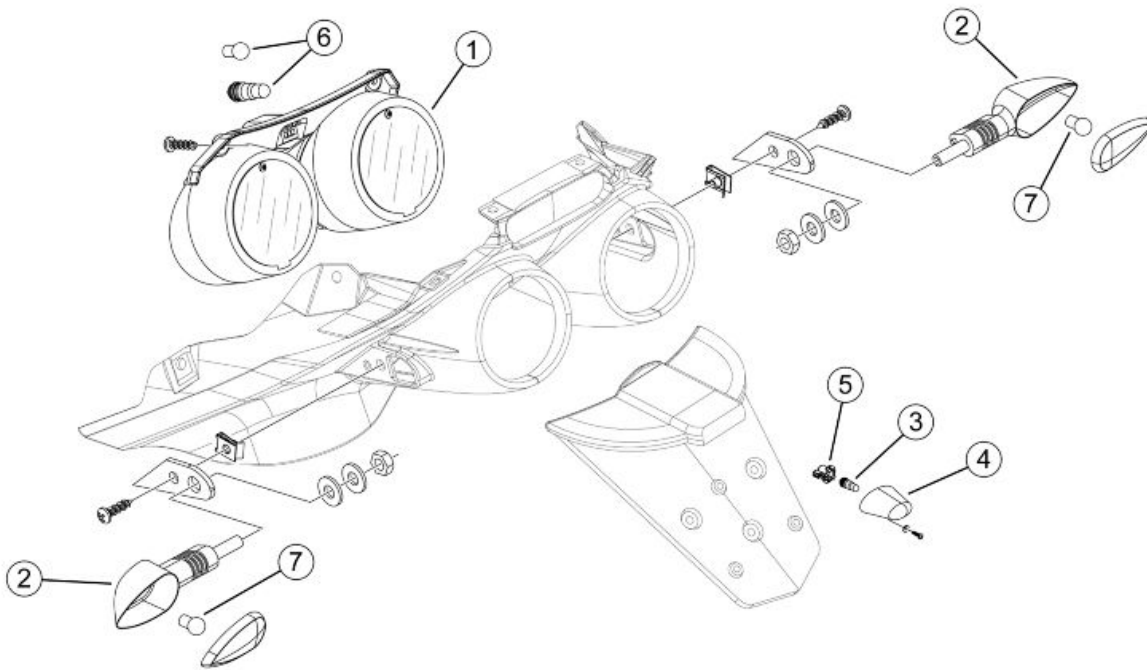

**REAR TURN INDICATORS INDICATOR LIGHTS**

	<b>Code</b>	<b>Action</b>	<b>Duration</b>
1	005005	Taillight - Replacement	
2	005022	Rear turn indicators - replace	
3	005031	Licence plate light bulb - Replacement	
4	005032	Transparent licence plate cover - replace	
5	005131	Licence plate light support - Replacement	
6	005066	Rear light bulbs - Replacement	
7	005068	Rear turn indicator bulb - Replacement	

## Front wheel

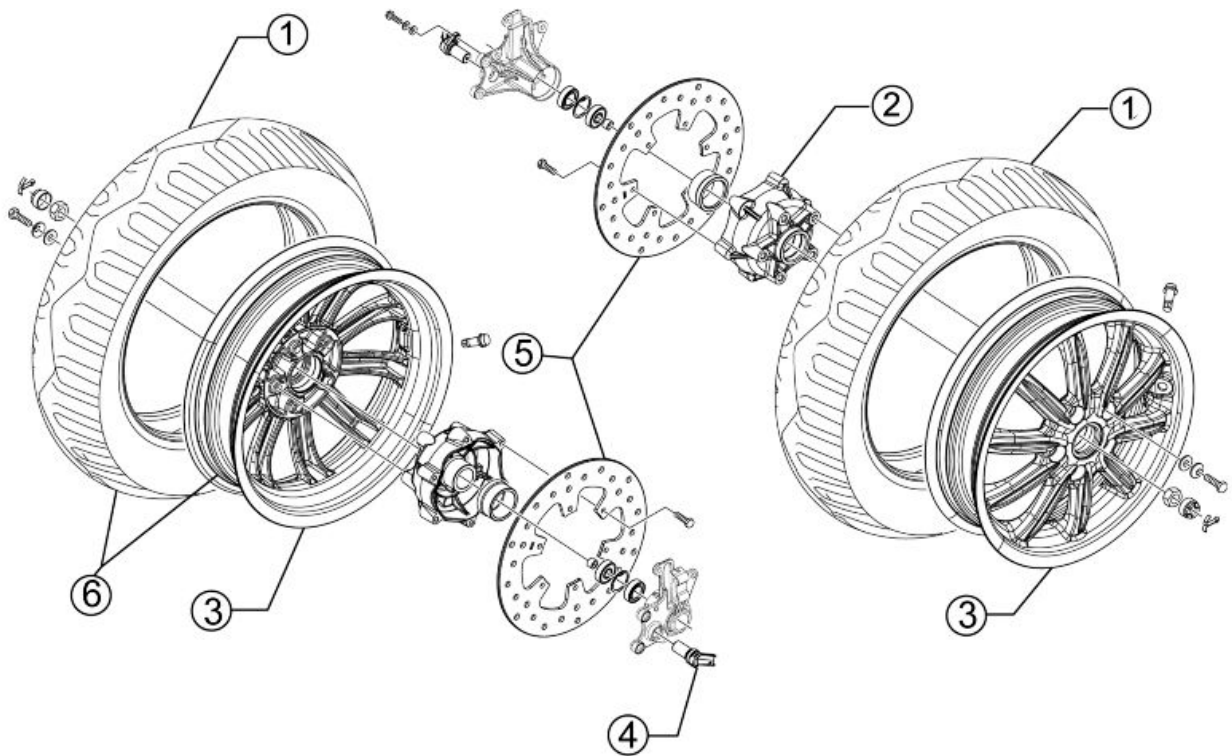
**FRONT WHEELS**

	<b>Code</b>	<b>Action</b>	<b>Duration</b>
1	003047	Front tyre - replace	
2	003033	Front wheel hub- Replacement	
3	003037	Front wheel rim- Replacement	
4	005089	Tone wheel - Replacement	
5	002041	Front brake disc - Replacement	
6	004123	Front wheel - Replacement	

## Rear wheel

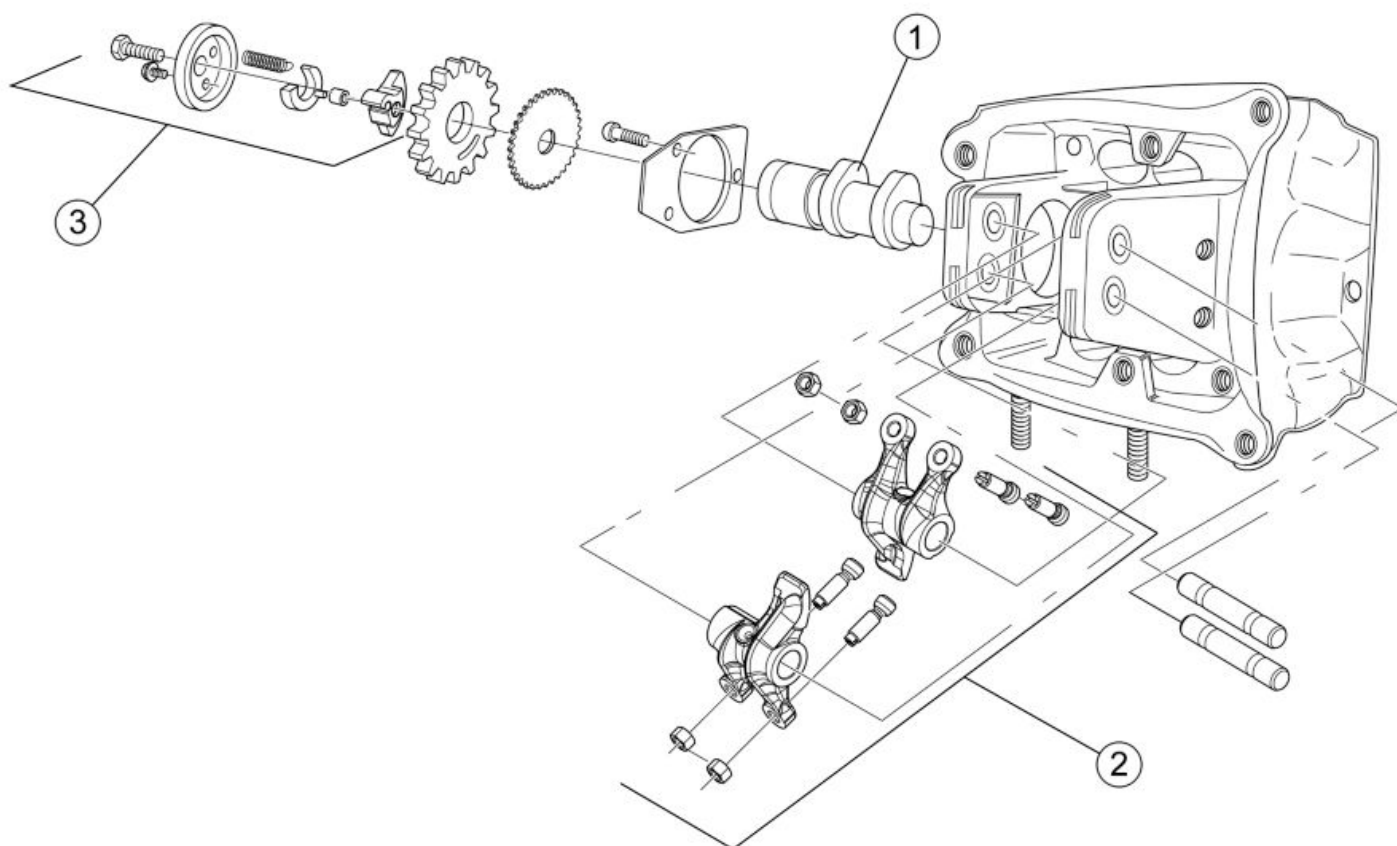
**REAR WHEEL**

	<b>Code</b>	<b>Action</b>	<b>Duration</b>
1	002070	Rear brake disc - Replacement	
2	001016	Rear wheel - Replacement	
3	001071	Front wheel rim - Removal and refitting	
4	004126	Rear wheel tyre - Replacement	

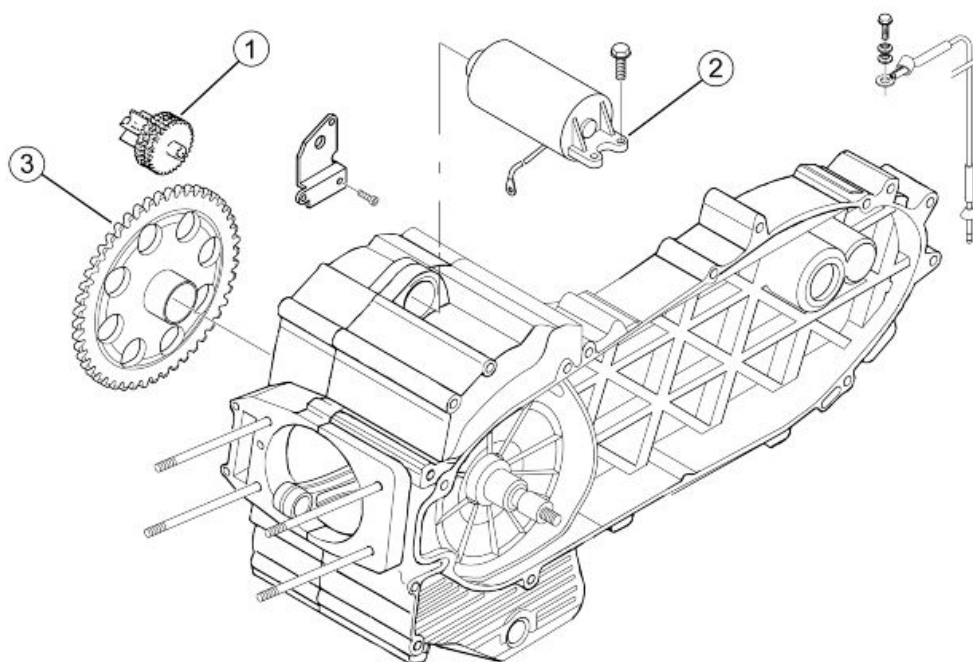

## Electric start

**AVVIAMENTO**

	<b>Code</b>	<b>Action</b>	<b>Duration</b>
1	001017	Start-up pinion - Replacement	
2	001020	Starter motor - Replacement	
3	001151	Start-up driven gearing - Replacement	

## Electric devices

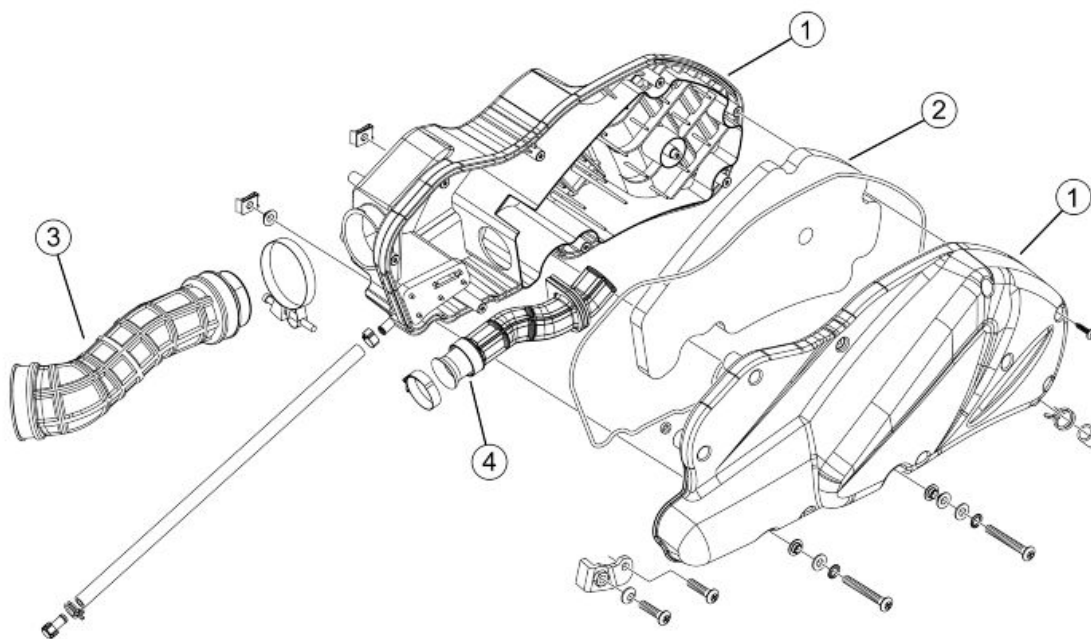

### **DISPOSITIVI ELETTRICI**

	<b>Code</b>	<b>Action</b>	<b>Duration</b>
1	005035	Headlight remote control - Replacement	
2	005011	Start-up remote control switch - Replacement	
3	005007	Battery - Replacement	
4	005003	Horn - Replacement	
5	005096	Remote control for injection components - Replacement	
6	005117	Electrical fan remote control - Replacement	
7	xxxxxx	Teleruttore consenso avviamento - sostituzione	
8	005052	Fuse - Replacement	
9	832311	Turn indicator blinker - Replacement	

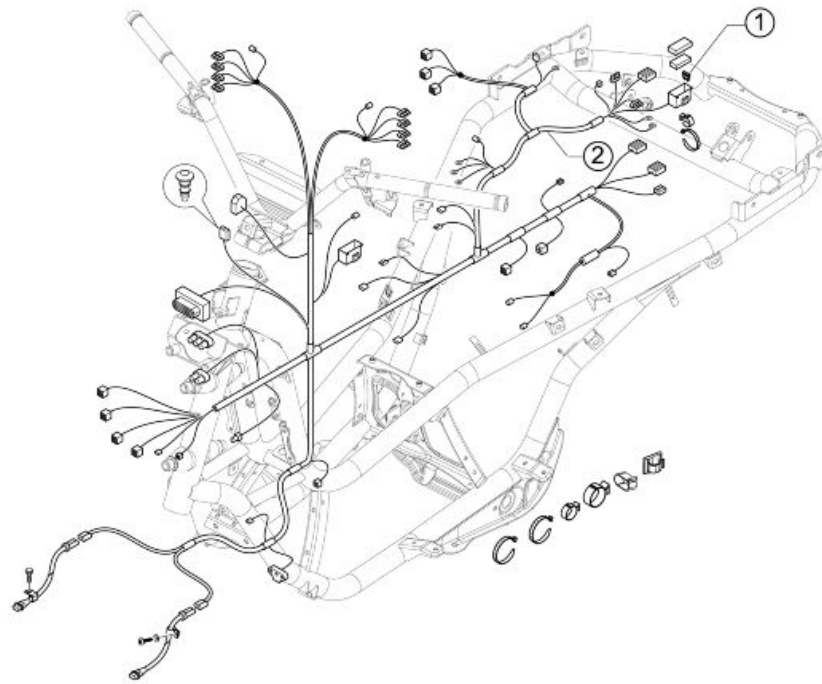

**CABLE HARNESS**

	Code	Action	Duration
1	005001	electric system - change	
2	005114	Electrical system - Service	

**Electronic controls**

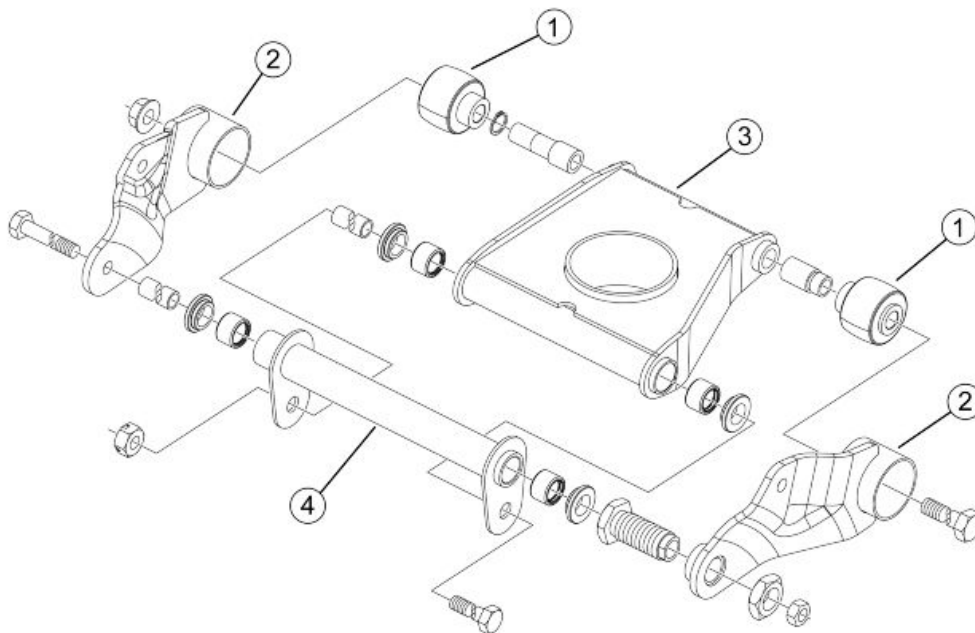

**COMANDI AL MANUBRIO**

	<b>Code</b>	<b>Action</b>	<b>Duration</b>
1	005017	Stop switch - Replacement	
2	005077	Emergency stop switch - Replacement	
3	005041	Starter button - replace	
4	005040	Horn button - Replacement	
5	005006	Light switch or turn indicators - Replacement	
6	005039	Headlight switch - replace	
7	005142	Unlocking switch - Replacement	
8	005084	Emergency light switch - Replacement	
9	005143	MODE button - Replacement	
10	888126	Pulsante sottosella - sostituzione	

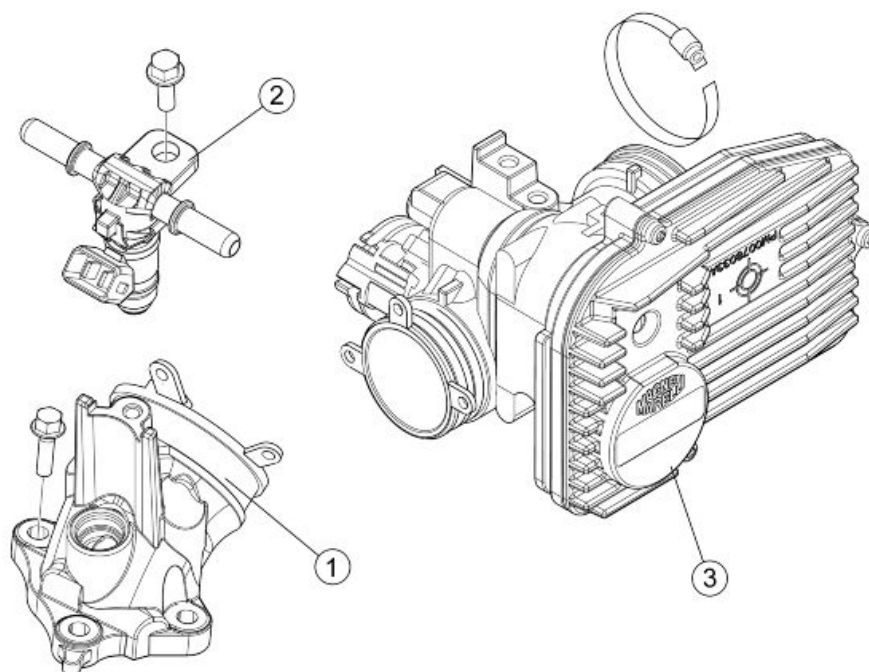
**Transmissions****TRASMISSIONI SERRATURE**

	<b>Code</b>	<b>Action</b>	<b>Duration</b>
1	003094	Tilt locking calliper control cable - replacement	
2	002082	Fuel tank cap opening drive - Replacement	
3	002083	Saddle opening transmission - Replacement	

	Code	Action	Duration
4	002026	Trasmissione freno di stazionamento - sostituzione	
5	002092	Transmission splitter/ hook transmission - Replacement	

**Helmet bay**

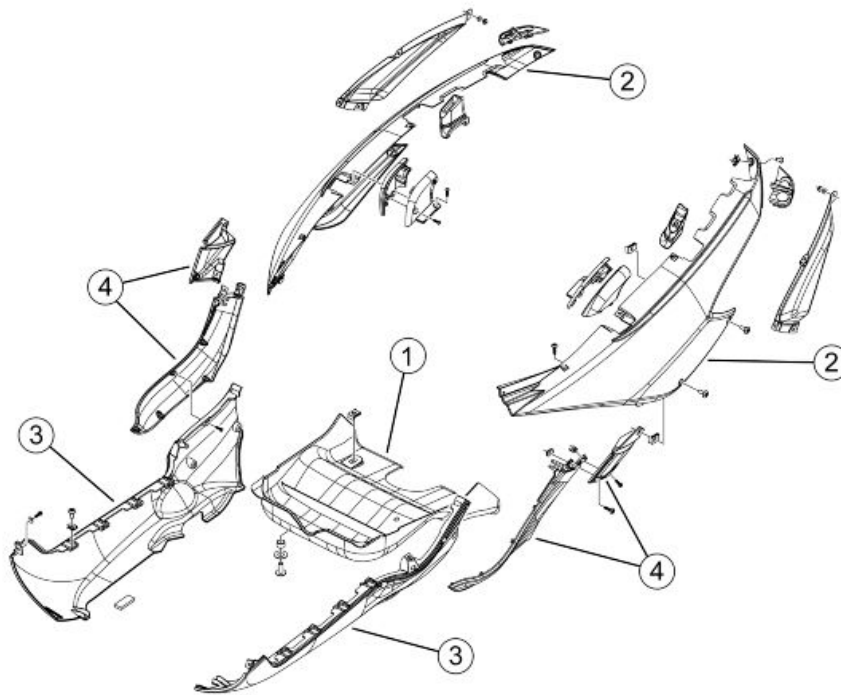

**HELMET COMPARTMENT**

	Code	Action	Duration
1	005046	Battery cover - change	
2	005026	Helmet compartment bulb - Replacement	
3	005027	Helmet compartment bulb support - Replacement	
4	004016	Helmet compartment - replace	
5	004142	Plug socket - Replacement	

## Front suspension

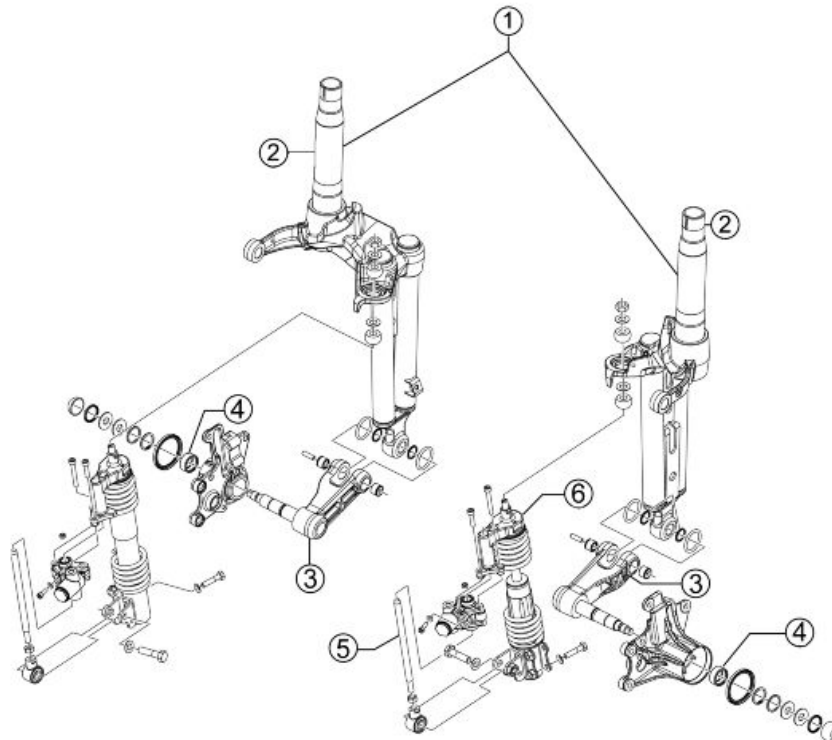

### FRONT SUSPENSION

	<b>Code</b>	<b>Action</b>	<b>Duration</b>
1	003010	Front suspension - Service	
2	003111	Side steering tube - replacement	
3	003038	Front wheel axle - Remov. and Refitt.	
4	003040	Front wheel bearings - Replacement	
5	003107	Sliding stems - replacement	
6	003113	Front shock absorber - replacement	

Cooling system

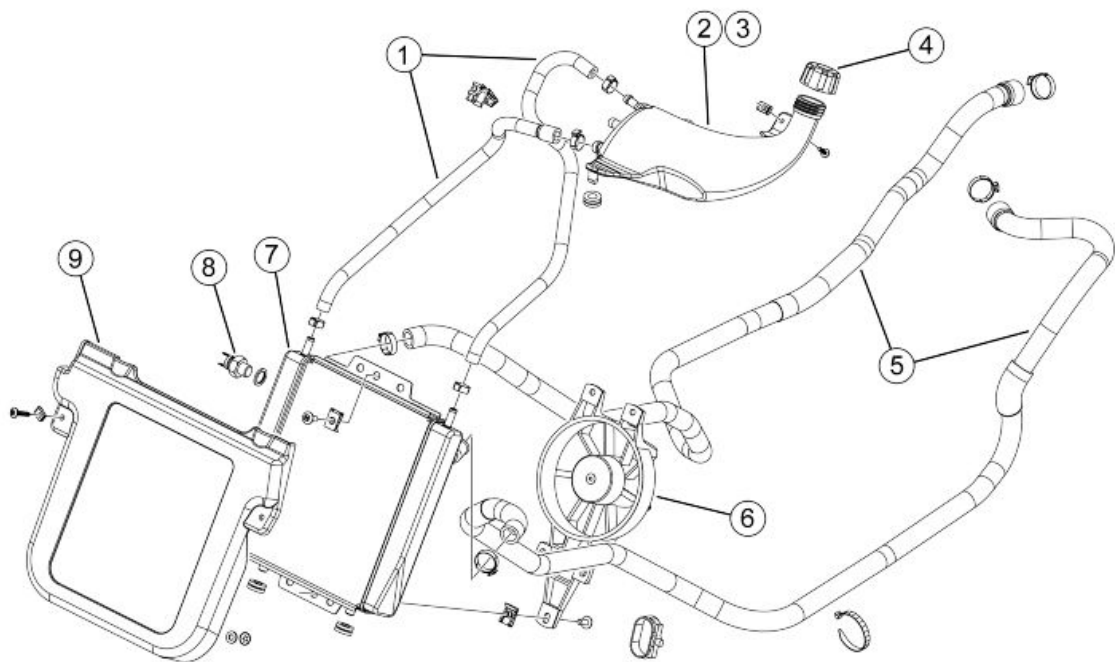

**IMPIANTO DI RAFFREDDAMENTO**

	<b>Code</b>	<b>Action</b>	<b>Duration</b>
1	007013	Radiator expansion tank connection pipe - Replacement	
2	001052	Coolant and air bleed - Replacement	
3	007001	Expansion tank - Replacement	
4	007024	Expansion tank cap - Replacement	
5	007003	Coolant delivery and return pipe - Replacement	
6	007016	Fan with support - Replacement	
7	007002	Water radiator - replacement	
8	007014	Radiator thermal switch - Replacement	
9	004167	Grill / radiator cover - Replacement	

## Braking system

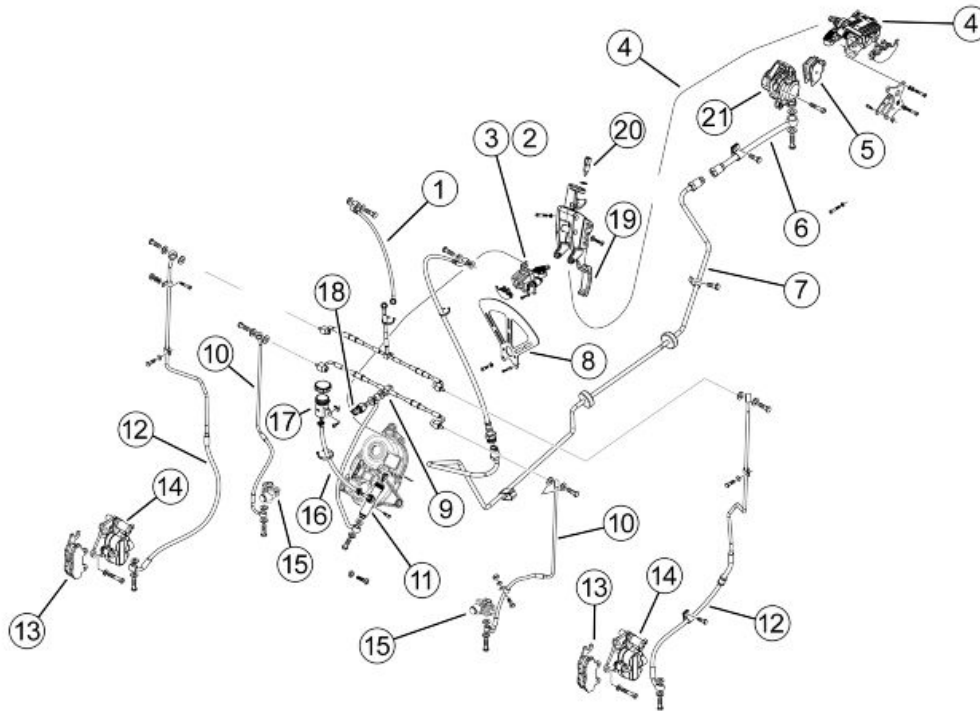

### IMPIANTO FRENANTE

	Code	Action	Duration
1	002025	Brake piping - Replacement	
2	003096	Tilt locking calliper- replacement	
3	003100	Tilt locking calliper pads - replacement	
4	003109	Parking brake mechanical calliper - replacement	
5	002002	Shoes - Rear brake pads - Replacement	
6	002020	Rear brake pipes - Removal and refitting	
7	002081	Rear brake disc piping - Replacement	
8	003118	Tilt locking disc section - replacement	
9	003103	Splitter for suspension locking system hoses- replacement	
10	003102	Hoses for the splitter-calliper suspension locking system - replacement	
11	003088	Tilt locking hydraulic pump - replacement	
12	002021	Front brake piping - Replacement	



	<b>Code</b>	<b>Action</b>	<b>Duration</b>
13	002007	Front brake pads - Replacement	
14	002039	Front brake calliper - Replacement	
15	003104	Suspension system locking calliper- replacement	
16	003119	Hoses for the pump-splitter suspension locking system - replacement	
17	003105	Suspension locking system brake fluid - repl.	
18	003106	Suspension locking system pressure sensor- Replacement	
19	003121	Parking brake control lever - replacement	
20	003122	Parking brake control lever micro-switch - replacement	
21	002048	Rear brake calliper - Replacement	

**Stickers**

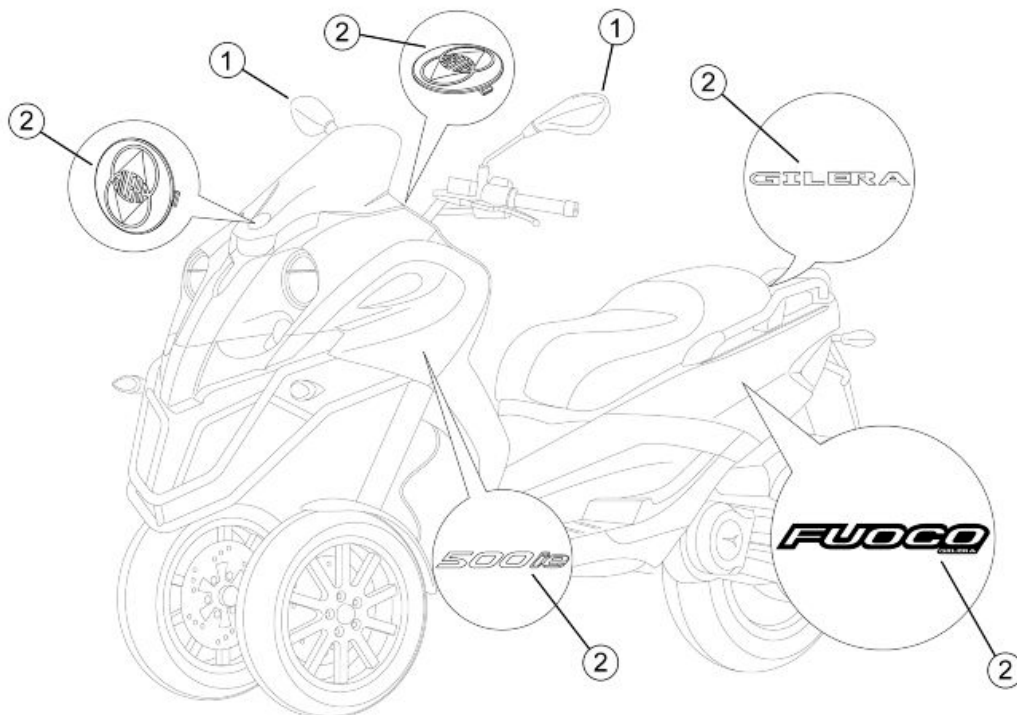

**TRANSFERS**

	<b>Code</b>	<b>Action</b>	<b>Duration</b>
1	004066	Driving mirror - Replacement	
2	004159	Plates / Stickers - Replacement	

## The tilt mechanism

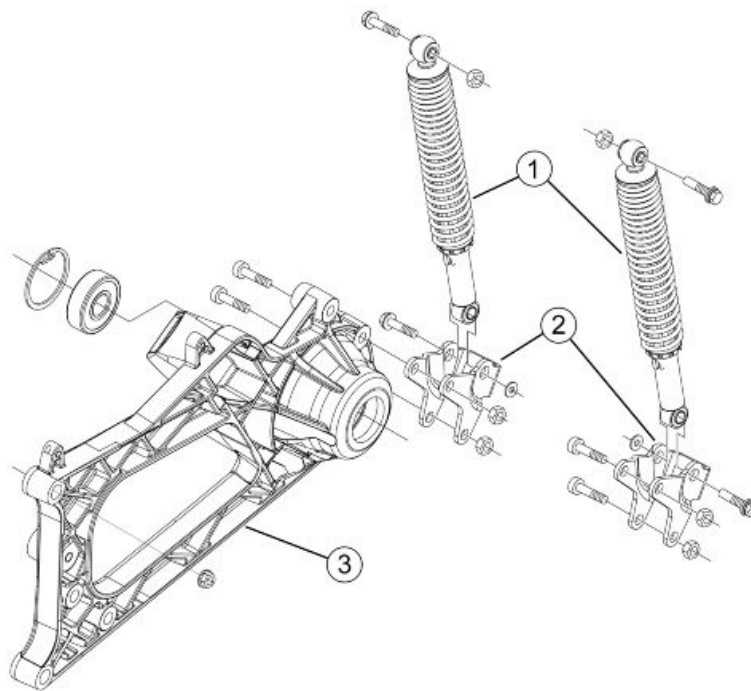

<u>TILT MECHANISM</u>			
	<b>Code</b>	<b>Action</b>	<b>Duration</b>
1	003073	Steering clearance - Adjustment	
2	003112	Central steering tube - replacement	
3	003002	Steering fifth wheel - Replacement	
4	003115	Parallelogram arms - replacement	
5	003114	Parallelogram bearings - replacement	
6	003116	Steering rod - replacement	
7	003117	Constant-velocity universal joint - replacement	

## Geared motor

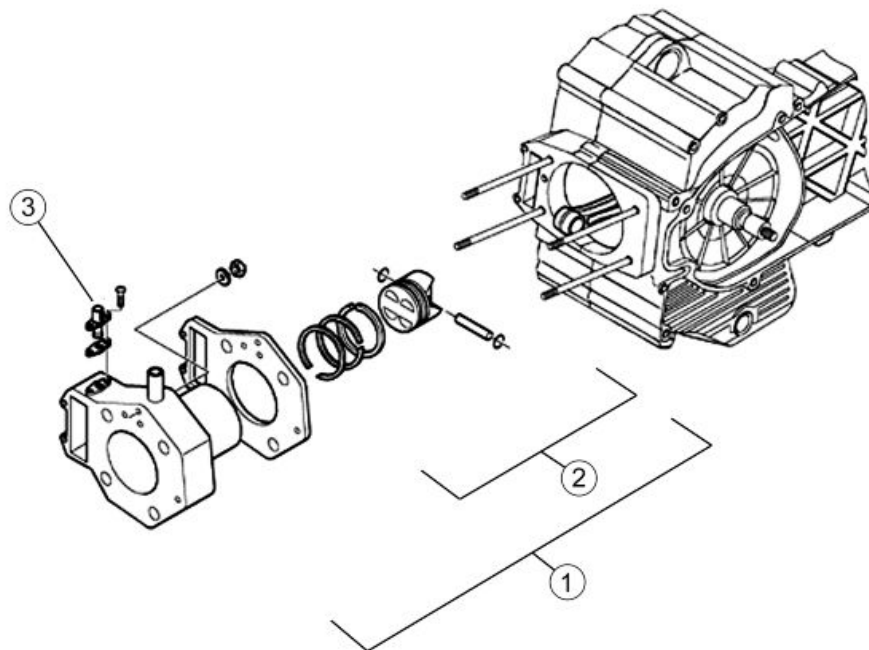

<b>MOTORIDUTTORE</b>			
	<b>Code</b>	<b>Action</b>	<b>Duration</b>
1	003101	Tilt locking calliper control lever - replacement	
2	005009	Voltage regulator - replace	
3	003095	Tilt locking calliper support bracket - replacement	
4	001069	HV coil - replace	
5	001094	Spark plug cap - Replacement	
6	003120	Tilt locking control unit - replacement	
7	003093	Geared motor crankcase - replacement	
8	003090	Geared electric motor - replacement	
9	003092	Geared motor bearings - replacement	
10	003091	Geared motor pinion - replacement	
11	003089	Geared motor potentiometer - replacement	
12	003097	Tilt locking calliper micro-switch - replacement	
13	XXXXXX	Centralina alimentazione MIU - Sostituzione	
14	005099	Electric saddle opening device - Replacement	

Time

**Fuoco 500 i.e.**

---

---